

Oak Harbor Rocket Open

Division 1 Novice 39-42

Round 1

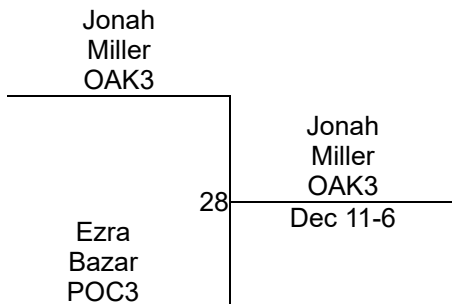

Round 2

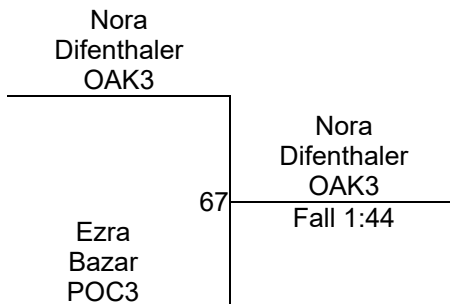

Round 3

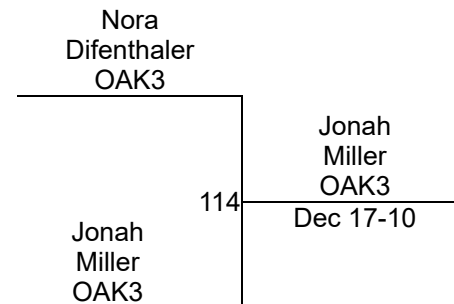

J. Miller (OAK3)
1ST

N. Difenthaler (OAK3)
2ND

E. Bazar (POC3)
3RD

Oak Harbor Rocket Open

Division 1 Novice 43-45

Round 1

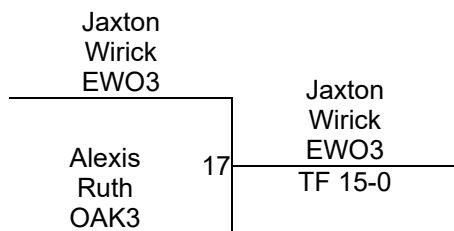
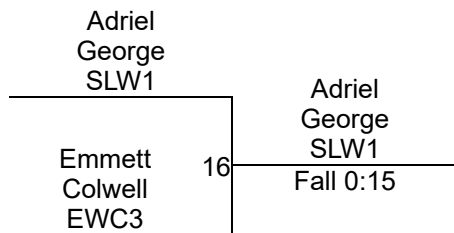

Round 2

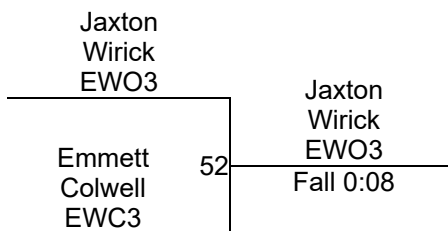
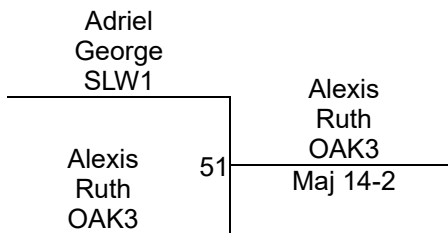

Round 3

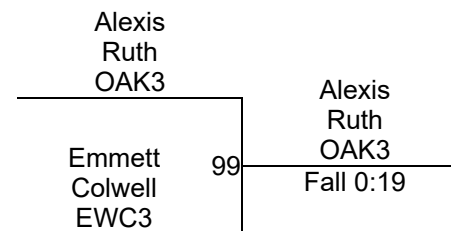
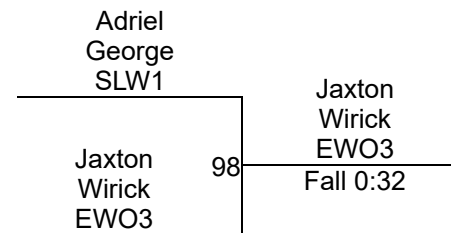

WRESTLERS

A. George (SLW1)

E. Colwell (EWC3)

J. Wirick (EWO3)

A. Ruth (OAK3)

J. Wirick (EWO3)

1ST

A. Ruth (OAK3)

2ND

A. George (SLW1)

3RD

E. Colwell (EWC3)

4TH

Oak Harbor Rocket Open

Division 1 Novice 46-48

Round 1

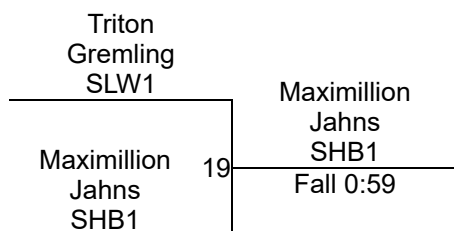
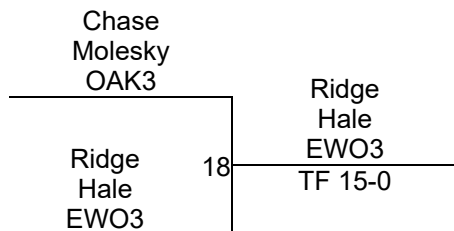

Round 2

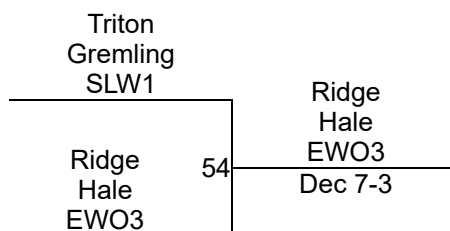
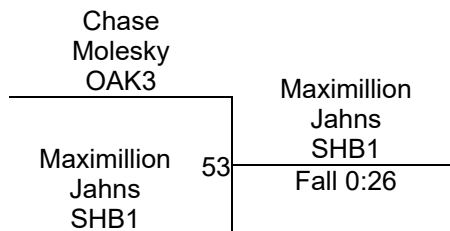

Round 3

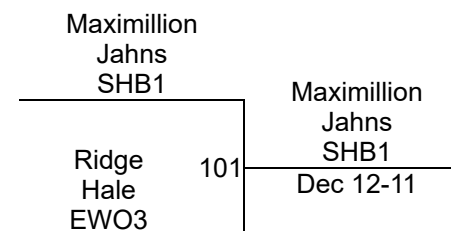
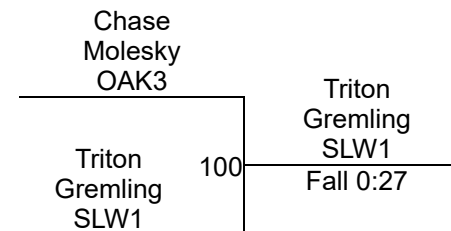

WRESTLERS

C. Molesky (OAK3)

R. Hale (EWO3)

T. Gremling (SLW1)

M. Jahns (SHB1)

M. Jahns (SHB1)

1ST

R. Hale (EWO3)

2ND

T. Gremling (SLW1)

3RD

C. Molesky (OAK3)

4TH

Oak Harbor Rocket Open

Division 1 Novice 55-58

Round 1

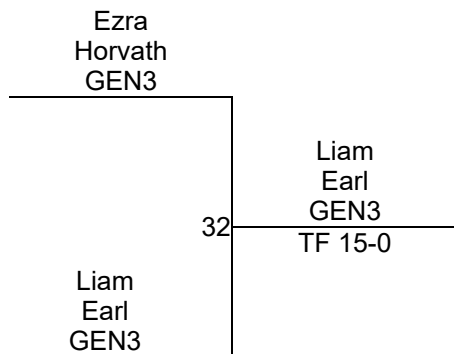

Round 2

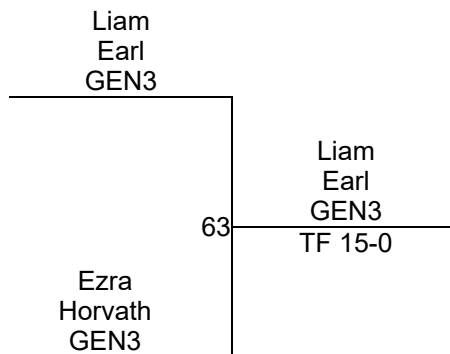

Round 3

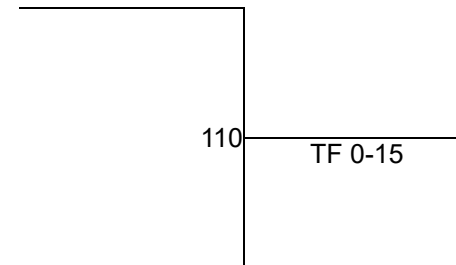

L. Earl (GEN3)
1ST

E. Horvath (GEN3)
2ND

Oak Harbor Rocket Open

Division 2 Novice 45-47

Round 1

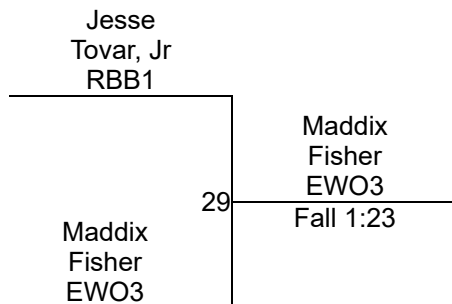

Round 2

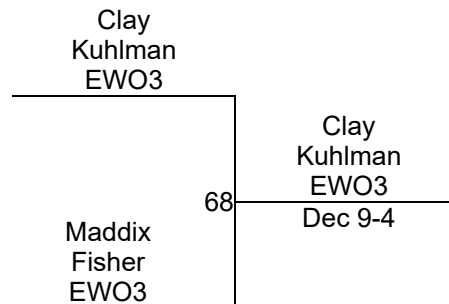

Round 3

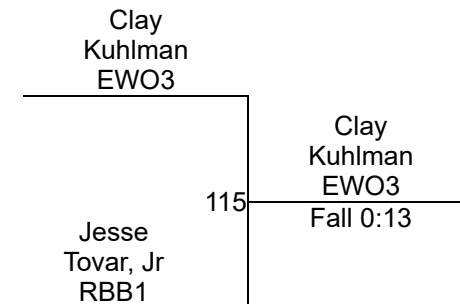

C. Kuhlman (EWO3)
1ST

M. Fisher (EWO3)
2ND

J. Tovar, Jr (RBB1)
3RD

Oak Harbor Rocket Open

Division 2 Novice 57-59

Round 1

Kaleb Giaimo RBB1		Titus Lochotzki POC3	
Titus Lochotzki POC3	4	Fall 0:40	

Devin Huston OAK3		Devin Huston OAK3	
Johnathan Brown, Jr POC3	5	TF 18-3	

B. Hoffmann (EWO3)
1ST

Round 2

Bowen Hoffmann EWO3		Bowen Hoffmann EWO3	
Johnathan Brown, Jr POC3	36	Fall 0:18	

Kaleb Giaimo RBB1		Devin Huston OAK3	
Devin Huston OAK3	37	TF 16-1	

D. Huston (OAK3)
2ND

Round 3

Bowen Hoffmann EWO3		Bowen Hoffmann EWO3	
Devin Huston OAK3	71	Fall 1:38	

Titus Lochotzki POC3		Titus Lochotzki POC3	
Johnathan Brown, Jr POC3	72	TF 15-0	

T. Lochotzki (POC3)
3RD

Round 4

Bowen Hoffmann EWO3		Bowen Hoffmann EWO3	
Titus Lochotzki POC3	86	Fall 0:28	

Kaleb Giaimo RBB1		Johnathan Brown, Jr POC3	
Johnathan Brown, Jr POC3	87	SV-1 13-11	

J. Brown, Jr (POC3)
4TH

Round 5

Bowen Hoffmann EWO3		Bowen Hoffmann EWO3	
Kaleb Giaimo RBB1	121	TF 17-2	

Titus Lochotzki POC3		Devin Huston OAK3	
Devin Huston OAK3	122	Fall 0:34	

K. Giaimo (RBB1)
5TH

Oak Harbor Rocket Open

Division 2 Novice 59-61

Round 1

Jett Gradel OAK3	Jett Gradel OAK3
Beckett Layman EWO3	Fall 1:17
6	

Connor Work Columbian	Barrett Kratzer EWO3
Barrett Kratzer EWO3	Maj 12-0
7	

B. Kratzer (EWO3)
1ST

Round 2

McCoy Stoner EWO3	Barrett Kratzer EWO3
Barrett Kratzer EWO3	Dec 10-6
38	

Jett Gradel OAK3	Jett Gradel OAK3
Connor Work Columbian	Fall 2:00
39	

J. Gradel (OAK3)
2ND

Round 3

McCoy Stoner EWO3	Connor Work Columbian
Connor Work Columbian	Fall 2:39
73	

Beckett Layman EWO3	Barrett Kratzer EWO3
Barrett Kratzer EWO3	TF 20-5
74	

C. Work (Columbian)
3RD

Round 4

McCoy Stoner EWO3	McCoy Stoner EWO3
Beckett Layman EWO3	Fall 2:58
88	

Jett Gradel OAK3	Barrett Kratzer EWO3
Barrett Kratzer EWO3	TB-1 6-4
89	

M. Stoner (EWO3)
4TH

Round 5

McCoy Stoner EWO3	Jett Gradel OAK3
Jett Gradel OAK3	Fall 2:33
123	

Beckett Layman EWO3	Connor Work Columbian
Connor Work Columbian	TF 15-0
124	

B. Layman (EWO3)
5TH

Oak Harbor Rocket Open

Division 2 Novice 61-62

Round 1

Deklen Irvin POC3	20	Deklen Irvin POC3 Fall 0:34
Thomas Reinhart OAK3		

Luke Arnold OAK3	21	Christian Diefenthaler OAK3 TF 15-0
Christian Diefenthaler OAK3		

Round 2

Deklen Irvin POC3	55	Christian Diefenthaler OAK3 Dec 10-4
Christian Diefenthaler OAK3		

Luke Arnold OAK3	56	Thomas Reinhart OAK3 Dec 1-0
Thomas Reinhart OAK3		

Round 3

Deklen Irvin POC3	102	Deklen Irvin POC3 Fall 0:43
Luke Arnold OAK3		

Christian Diefenthaler OAK3	103	Christian Diefenthaler OAK3 Fall 0:34
Thomas Reinhart OAK3		

WRESTLERS

D. Irvin (POC3)

T. Reinhart (OAK3)

L. Arnold (OAK3)

C. Diefenthaler (OAK3)

C. Diefenthaler (OAK3)

1ST

D. Irvin (POC3)

2ND

T. Reinhart (OAK3)

3RD

L. Arnold (OAK3)

4TH

Oak Harbor Rocket Open

Division 2 Novice 63-64

Round 1

Eddie Barnette SLW1		Finn Kuhlman EWO3	
Finn Kuhlman EWO3	8	Fall 2:22	

Logan Simpson EWO3		Dominic Rosemond POC3	
Dominic Rosemond POC3	9	Maj 11-2	

D. Rosemond (POC3)
1ST

Round 2

Gavin Lump RBB1		Dominic Rosemond POC3	
Dominic Rosemond POC3	40	Fall 0:41	

Eddie Barnette SLW1		Eddie Barnette SLW1	
Logan Simpson EWO3	41	Fall 2:54	

F. Kuhlman (EWO3)
2ND

Round 3

Gavin Lump RBB1		Logan Simpson EWO3	
Logan Simpson EWO3	75	TF 15-0	

Finn Kuhlman EWO3		Dominic Rosemond POC3	
Dominic Rosemond POC3	76	Maj 10-0	

E. Barnette (SLW1)
3RD

Round 4

Gavin Lump RBB1		Finn Kuhlman EWO3	
Finn Kuhlman EWO3	90	Fall 0:17	

Eddie Barnette SLW1		Dominic Rosemond POC3	
Dominic Rosemond POC3	91	Fall 0:54	

L. Simpson (EWO3)
4TH

Round 5

Gavin Lump RBB1		Eddie Barnette SLW1	
Eddie Barnette SLW1	125	Fall 0:34	

Finn Kuhlman EWO3		Finn Kuhlman EWO3	
Logan Simpson EWO3	126	Fall 0:28	

G. Lump (RBB1)
5TH

Oak Harbor Rocket Open

Division 2 Novice 64.8-68

Round 1

Teddy Mason OAK3		Colton Moore OAK3
Colton Moore OAK3	22	Fall 0:31

Brayson Lewis POC3		Bentley Richards EWO3
Bentley Richards EWO3	23	TF 15-0

Round 2

Teddy Mason OAK3		Bentley Richards EWO3
Bentley Richards EWO3	57	Fall 0:54

Brayson Lewis POC3		Colton Moore OAK3
Colton Moore OAK3	58	Fall 0:17

Round 3

Teddy Mason OAK3		Brayson Lewis POC3
Brayson Lewis POC3	104	Fall 1:44

Bentley Richards EWO3		Colton Moore OAK3
Colton Moore OAK3	105	Fall 0:32

WRESTLERS

- T. Mason (OAK3)
- C. Moore (OAK3)
- B. Lewis (POC3)
- B. Richards (EWO3)

C. Moore (OAK3)
1ST

B. Richards (EWO3)
2ND

B. Lewis (POC3)
3RD

T. Mason (OAK3)
4TH

Oak Harbor Rocket Open

Division 2 Novice 68-70

Round 1

Tucker Magrum GEN3		Tanner Dauer EWO3	
Tanner Dauer EWO3	10	Dec 4-3	

Caleb Ruth OAK3		Caleb Ruth OAK3	
Alexavier George SLW1	11	Fall 0:57	

T. Dauer (EWO3)
1ST

Round 2

Coltan Sager RBB1		Coltan Sager RBB1	
Alexavier George SLW1	42	FF	

Tucker Magrum GEN3		Tucker Magrum GEN3	
Caleb Ruth OAK3	43	Maj 9-0	

T. Magrum (GEN3)
2ND

Round 3

Coltan Sager RBB1		Caleb Ruth OAK3	
Caleb Ruth OAK3	77	Dec 13-8	

Tanner Dauer EWO3		Tanner Dauer EWO3	
Alexavier George SLW1	78	FF	

C. Ruth (OAK3)
3RD

Round 4

Coltan Sager RBB1		Coltan Sager RBB1	
Tanner Dauer EWO3	92	Dec 15-11	

Tucker Magrum GEN3		Tucker Magrum GEN3	
Alexavier George SLW1	93	FF	

C. Sager (RBB1)
4TH

Round 5

Coltan Sager RBB1		Tucker Magrum GEN3	
Tucker Magrum GEN3	127	Fall 0:33	

Tanner Dauer EWO3		Tanner Dauer EWO3	
Caleb Ruth OAK3	128	Dec 8-4	

A. George (SLW1)
5TH

Oak Harbor Rocket Open

Division 2 Novice 71-73

Round 1

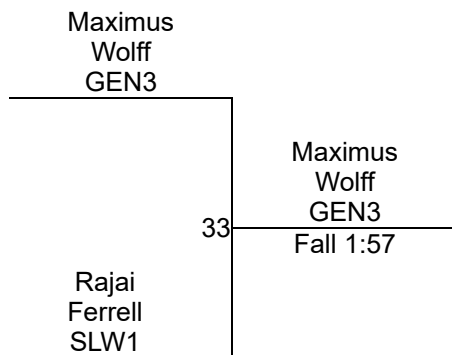

Round 2

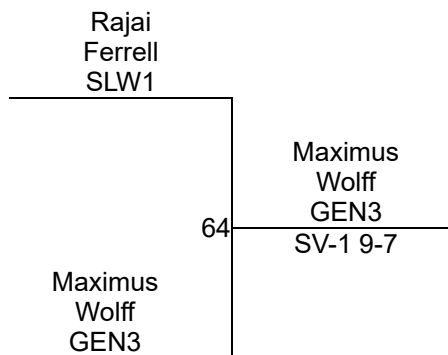

Round 3

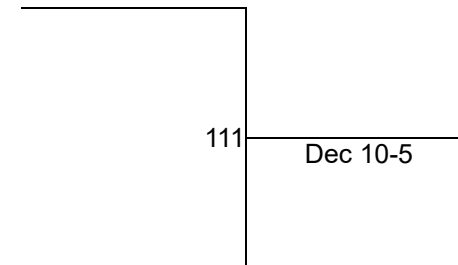

M. Wolff (GEN3)
1ST

R. Ferrell (SLW1)
2ND

Oak Harbor Rocket Open

Division 2 Novice 76-83

Round 1

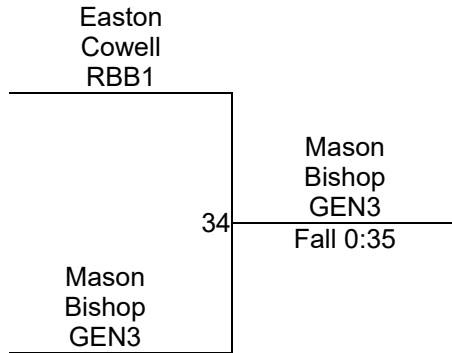

Round 2

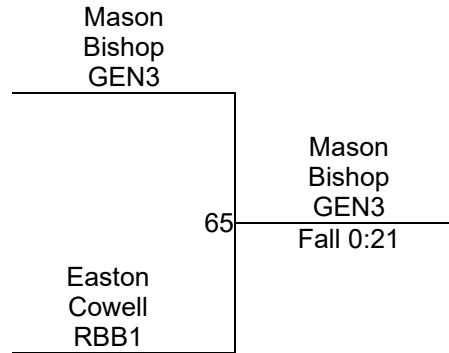

Round 3

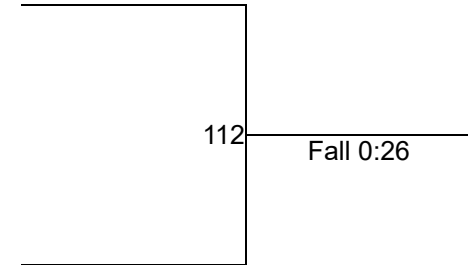

M. Bishop (GEN3)
1ST

E. Cowell (RBB1)
2ND

Oak Harbor Rocket Open

Division 2 Novice 122

Round 1

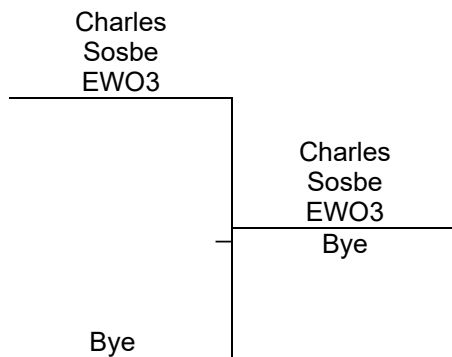

Round 2

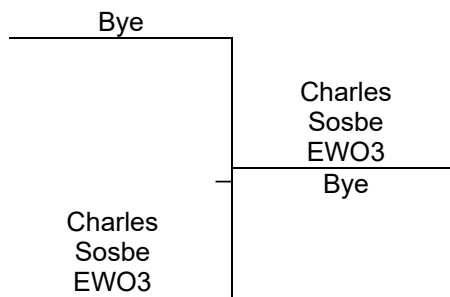

Round 3

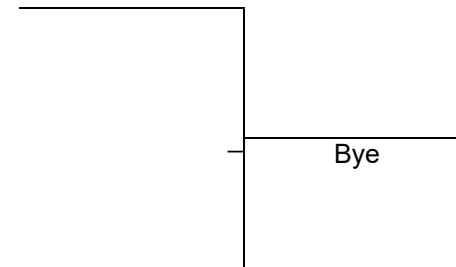

C. Sosbe (EWO3)
 1ST

Bye
 2ND

Oak Harbor Rocket Open

Division 3 Novice 55-63

Round 1

Julian Deanda EWO3	24	Julian Deanda EWO3
Charlie Lorenz POC3		Fall 1:25

Rowan Bills FUW2	25	Auden Resendez GEN3
Auden Resendez GEN3		Dec 8-4

Round 2

Julian Deanda EWO3	59	Julian Deanda EWO3
Auden Resendez GEN3		Fall 2:53

Rowan Bills FUW2	60	Rowan Bills FUW2
Charlie Lorenz POC3		Fall 2:48

Round 3

Julian Deanda EWO3	106	Julian Deanda EWO3
Rowan Bills FUW2		Fall 1:40

Auden Resendez GEN3	107	Auden Resendez GEN3
Charlie Lorenz POC3		Fall 1:57

WRESTLERS

J. Deanda (EWO3)

C. Lorenz (POC3)

R. Bills (FUW2)

A. Resendez (GEN3)

J. Deanda (EWO3)

1ST

A. Resendez (GEN3)

2ND

R. Bills (FUW2)

3RD

C. Lorenz (POC3)

4TH

Oak Harbor Rocket Open

Division 3 Novice 64-66

Round 1

Carter Lindsay OAK3	26	Maddox Dangler Dec 4-2
Maddox Dangler		

Walker Finn OAK3	27	Walker Finn OAK3 Dec 5-3
Jude Molnar POC3		

Round 2

Carter Lindsay OAK3	61	Carter Lindsay OAK3 TF 15-0
Jude Molnar POC3		

Walker Finn OAK3	62	Maddox Dangler Dec 2-0
Maddox Dangler		

Round 3

Carter Lindsay OAK3	108	Carter Lindsay OAK3 Fall 0:48
Walker Finn OAK3		

Jude Molnar POC3	109	Maddox Dangler Fall 0:45
Maddox Dangler		

WRESTLERS

C. Lindsay (OAK3)

M. Dangler ()

W. Finn (OAK3)

J. Molnar (POC3)

M. Dangler ()

1ST

C. Lindsay (OAK3)

2ND

W. Finn (OAK3)

3RD

J. Molnar (POC3)

4TH

Oak Harbor Rocket Open

Division 3 Novice 71-80

Round 1

Beckett Blausey OAK3		Clay Romstadt RBB1	
Clay Romstadt RBB1	12	TF 17-2	

Aiden Jones RBB1		Ayden Bills FUW2	
Ayden Bills FUW2	13	Fall 0:49	

C. Hotz (POC3)
1ST

Round 2

Carson Hotz POC3		Carson Hotz POC3	
Ayden Bills FUW2	44	Dec 2-1	

Beckett Blausey OAK3		Beckett Blausey OAK3	
Aiden Jones RBB1	45	Dec 10-4	

A. Bills (FUW2)
2ND

Round 3

Carson Hotz POC3		Carson Hotz POC3	
Aiden Jones RBB1	79	Fall 0:29	

Clay Romstadt RBB1		Ayden Bills FUW2	
Ayden Bills FUW2	80	Fall 2:36	

C. Romstadt (RBB1)
3RD

Round 4

Carson Hotz POC3		Carson Hotz POC3	
Clay Romstadt RBB1	94	Fall 0:52	

Beckett Blausey OAK3		Ayden Bills FUW2	
Ayden Bills FUW2	95	Fall 0:31	

B. Blausey (OAK3)
4TH

Round 5

Carson Hotz POC3		Carson Hotz POC3	
Beckett Blausey OAK3	129	Fall 0:54	

Clay Romstadt RBB1		Clay Romstadt RBB1	
Aiden Jones RBB1	130	Fall 2:49	

A. Jones (RBB1)
5TH

Oak Harbor Rocket Open

Division 3 Novice 86-89

Round 1

Marcus Borjas OAK3		Marcus Borjas OAK3
John Kelleher FFWA	14	Fall 0:41

Brantlee Myerholtz OAK3		Adam Buehler GEN3
Adam Buehler GEN3	15	Fall 0:53

M. Borjas (OAK3)
1ST

Round 2

Levi Steinmetz OAK3		Adam Buehler GEN3
Adam Buehler GEN3	46	Fall 0:31

Marcus Borjas OAK3		Marcus Borjas OAK3
Brantlee Myerholtz OAK3	47	Fall 2:52

A. Buehler (GEN3)
2ND

Round 3

Levi Steinmetz OAK3		Levi Steinmetz OAK3
Brantlee Myerholtz OAK3	81	Fall 2:39

John Kelleher FFWA		Adam Buehler GEN3
Adam Buehler GEN3	82	TF 17-1

L. Steinmetz (OAK3)
3RD

Round 4

Levi Steinmetz OAK3		Levi Steinmetz OAK3
John Kelleher FFWA	96	TF 16-0

Marcus Borjas OAK3		Marcus Borjas OAK3
Adam Buehler GEN3	97	Fall 1:48

B. Myerholtz (OAK3)
4TH

Round 5

Levi Steinmetz OAK3		Marcus Borjas OAK3
Marcus Borjas OAK3	131	TF 15-0

John Kelleher FFWA		Brantlee Myerholtz OAK3
Brantlee Myerholtz OAK3	132	Dec 13-6

J. Kelleher (FFWA)
5TH

Oak Harbor Rocket Open

Division 3 Novice 95-102

C. Sitterson			
C. Turinsky	1	C. Turinsky	Fall 0:17

C. Sitterson			
K. George	48	K. George	TF 16-1

C. Sitterson			
C. Perry	83	C. Perry	TF 15-0

C. Sitterson			
C. Gurierrez	118	C. Gurierrez	TF 16-1

C. Sitterson			
J. Granger	133	J. Granger	Fall 0:34

Round 1

J. Granger			
C. Gurierrez	2	J. Granger	Dec 8-3

Round 2

J. Granger			
C. Perry	49	J. Granger	Dec 6-3

Round 3

J. Granger			
C. Turinsky	84	C. Turinsky	TF 15-0

Round 4

J. Granger			
K. George	119	K. George	Fall 1:33

Round 5

C. Gurierrez			
C. Perry	134	C. Perry	Fall 2:56

C. Perry			
K. George	3	K. George	TF 17-2

C. Gurierrez			
C. Turinsky	50	C. Turinsky	TF 15-0

C. Gurierrez			
K. George	85	K. George	Fall 1:00

C. Perry			
C. Turinsky	120	C. Turinsky	Fall 1:19

K. George			
C. Turinsky	135	C. Turinsky	Fall 2:33

Coleman Turinsky (POC3)

1ST

Kayden George (SLW1)

2ND

Jaxon Granger (RBB1)

3RD

Cooper Perry (OAK3)

4TH

Carlos Gurierrez (SLW1)

5TH

Caroline Sitterson (GEN3)

6TH

Oak Harbor Rocket Open

Division 3 Novice 116-133

Round 1

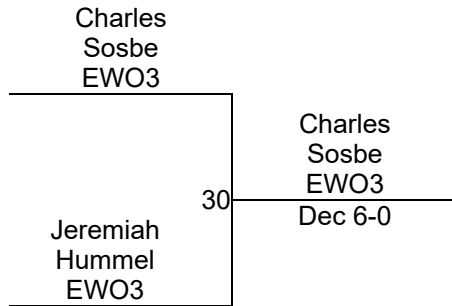

Round 2

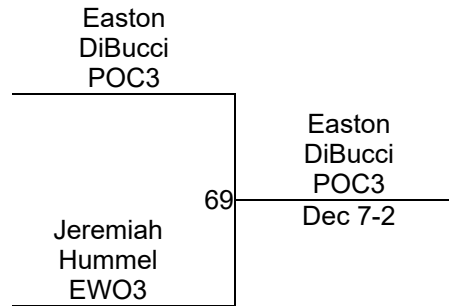

Round 3

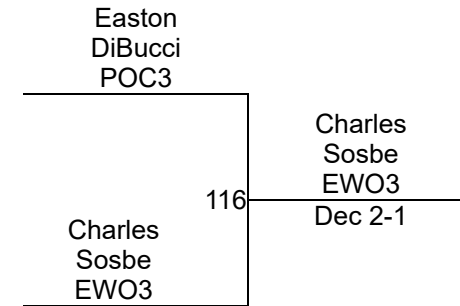

C. Sosbe (EWO3)
1ST

E. DiBucci (POC3)
2ND

J. Hummel (EWO3)
3RD

Oak Harbor Rocket Open

Division 4 Novice 65-78

Round 1

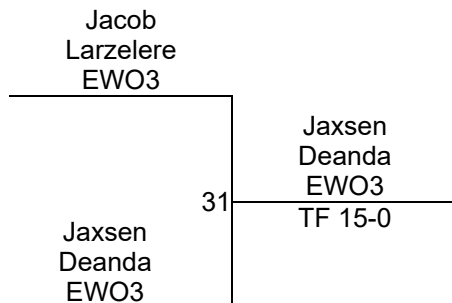

Round 2

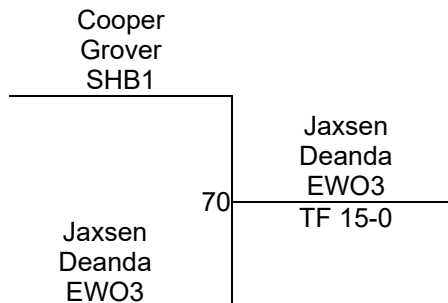

Round 3

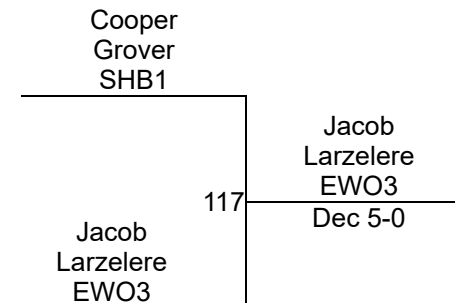

J. Deanda (EWO3)
 1ST

J. Larzelere (EWO3)
 2ND

C. Grover (SHB1)
 3RD

Oak Harbor Rocket Open

Division 4 Novice 81-97

Round 1

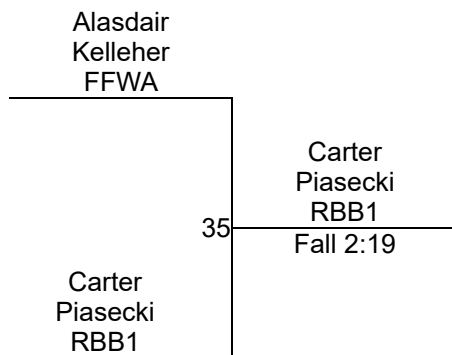

Round 2

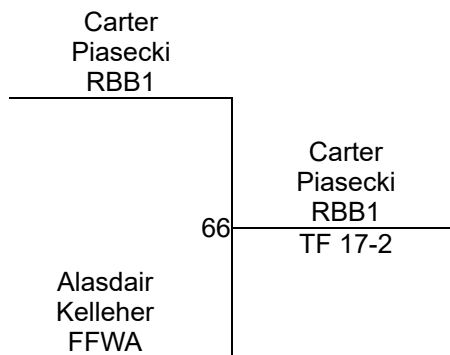

Round 3

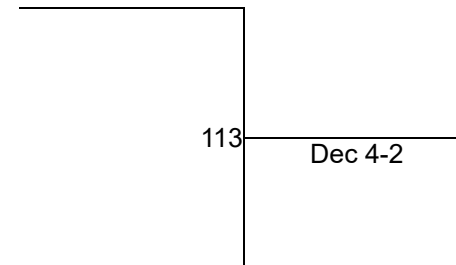

C. Piasecki (RBB1)
1ST

A. Kelleher (FFWA)
2ND