

Perkins Pirates Open

Division I Novice 41-43

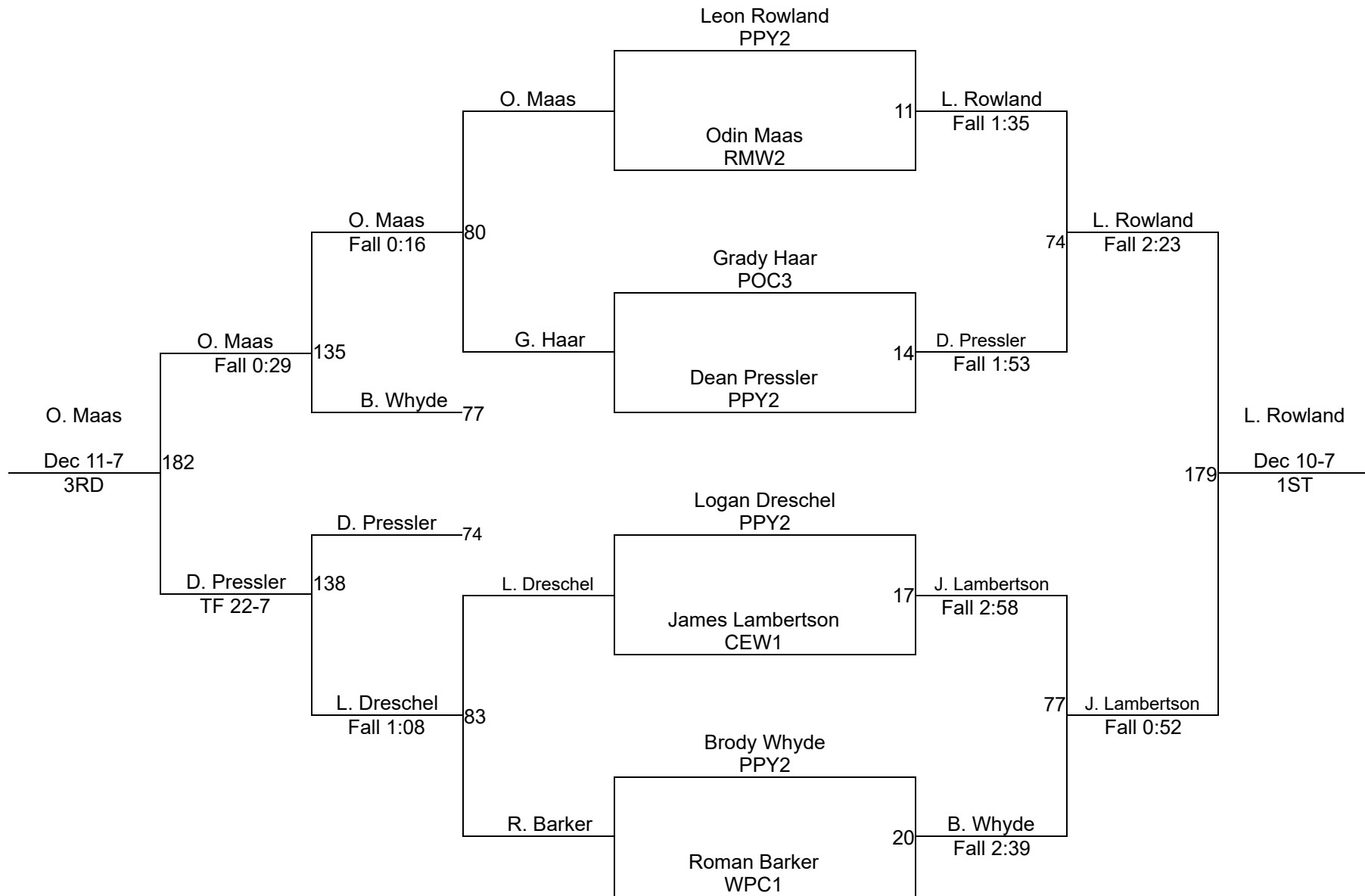

Perkins Pirates Open

Division I Novice 43-48

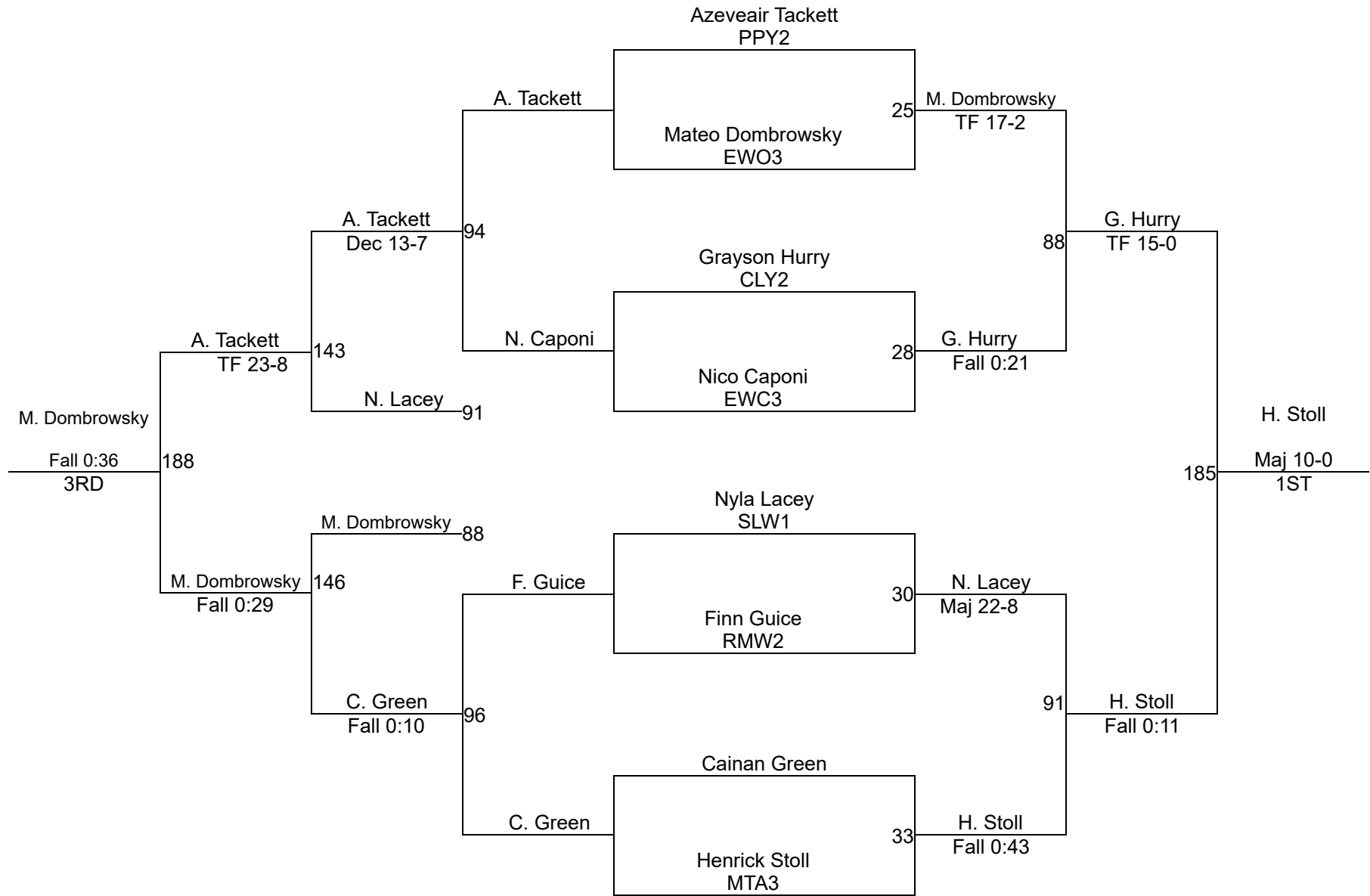

Perkins Pirates Open

Division I Novice 49-51

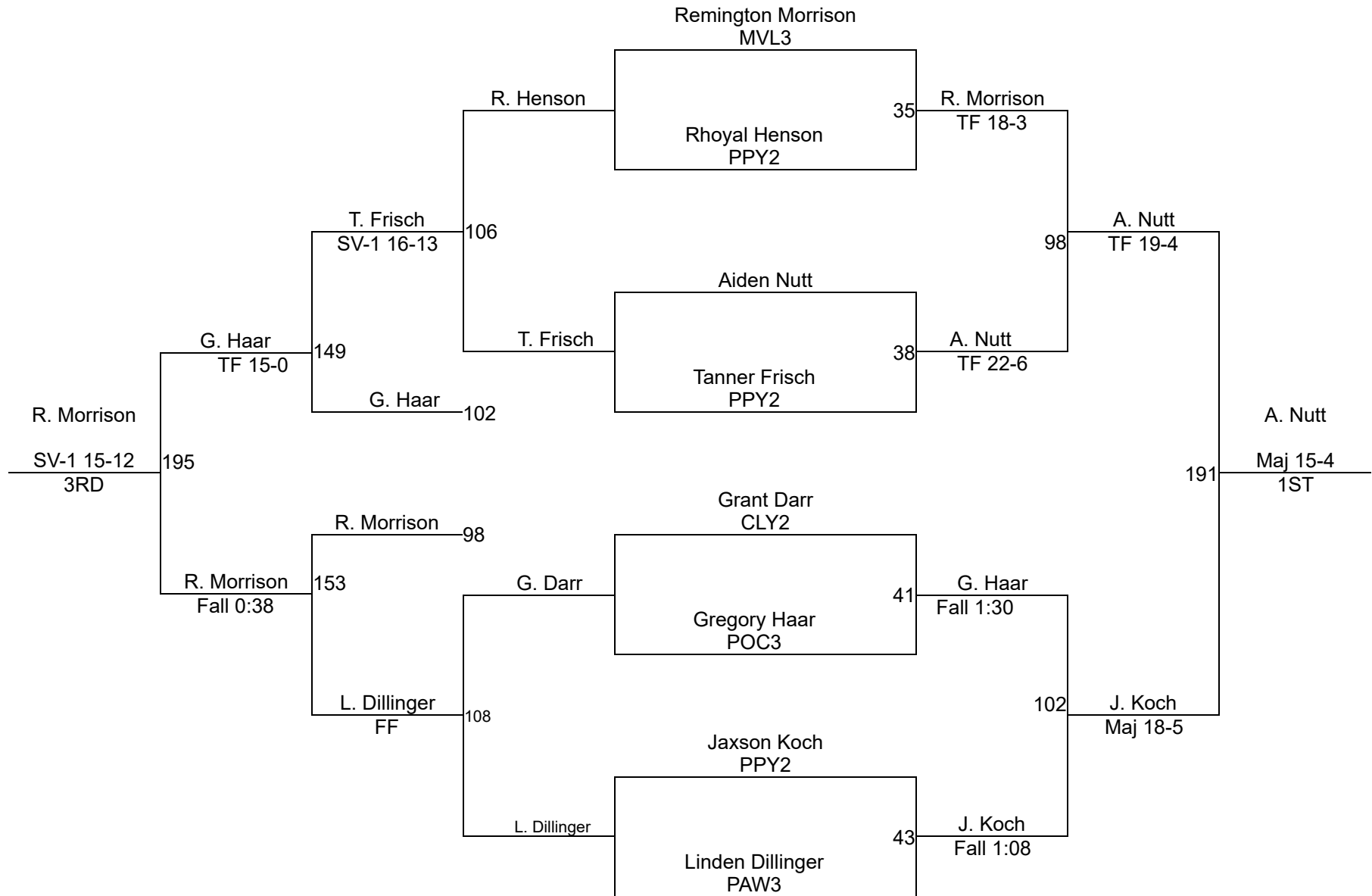

Perkins Pirates Open

Division I Novice 51-56

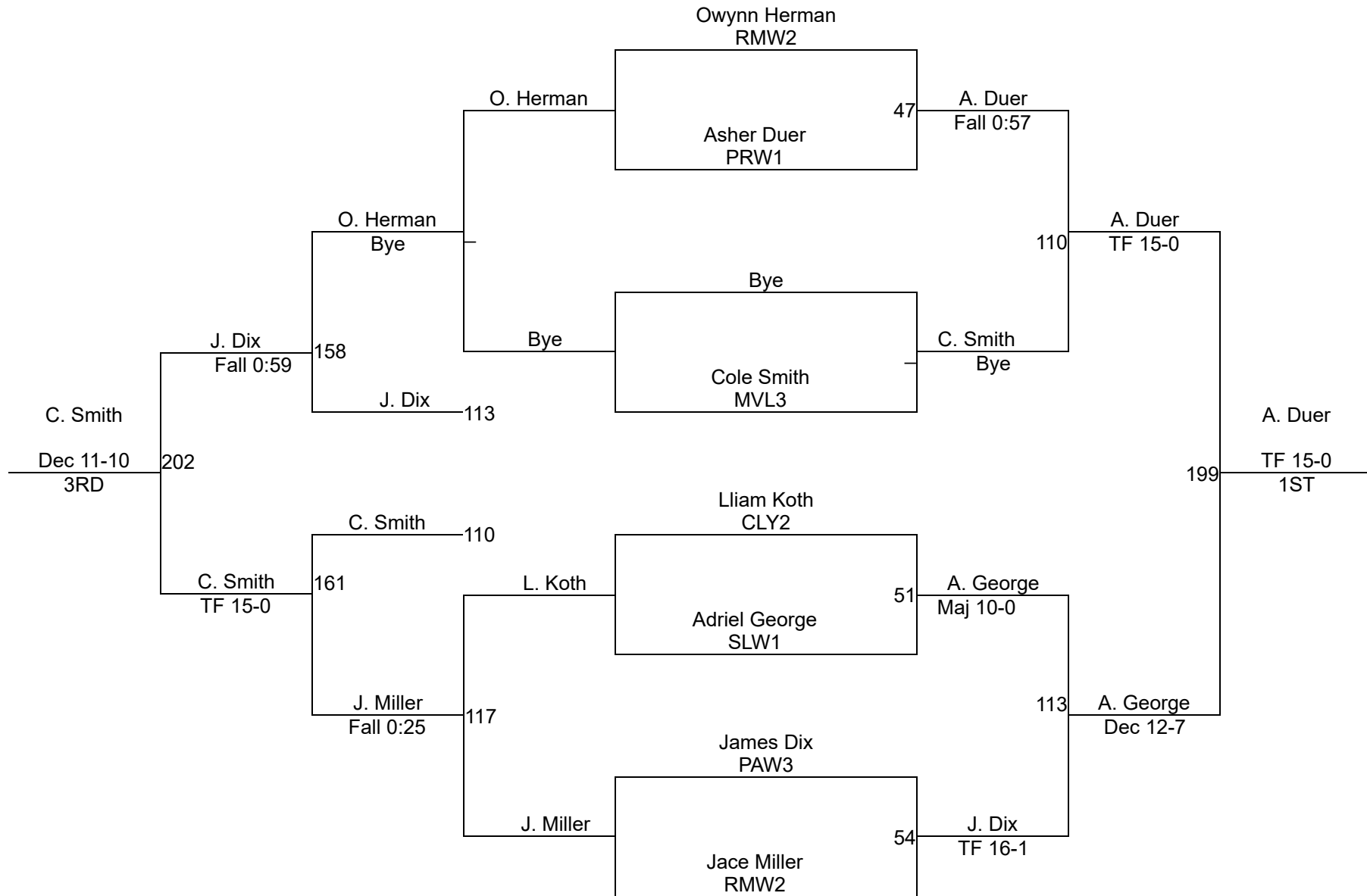

Perkins Pirates Open

Division I Novice 60-65

Round 1

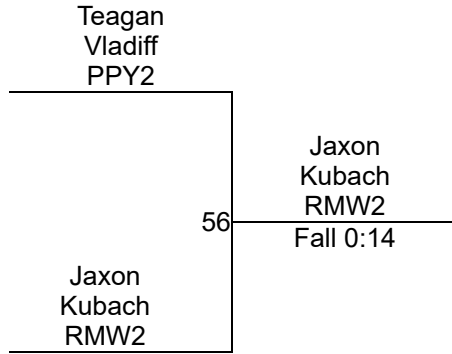

Round 2

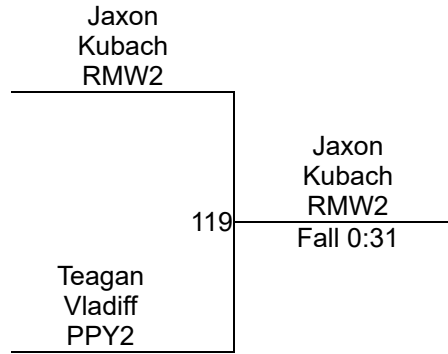

Round 3

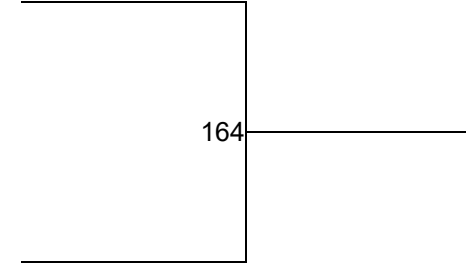

J. Kubach (RMW2)
1ST

T. Vladiff (PPY2)
2ND

Perkins Pirates Open

Division I Novice 85-85

Round 1

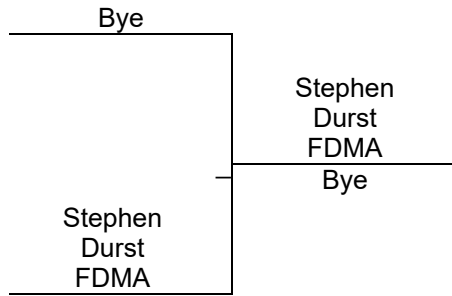

Round 2

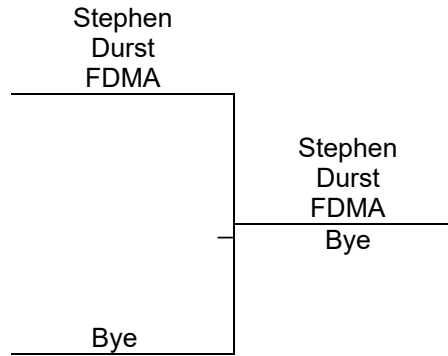

Round 3

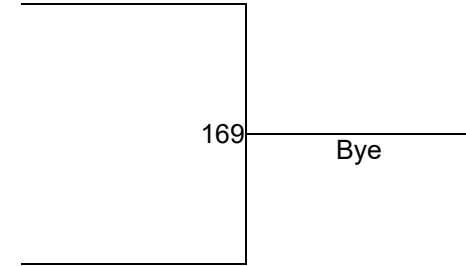

S. Durst (FDMA)
1ST

Bye
2ND

Perkins Pirates Open

Division II Novice 44-49

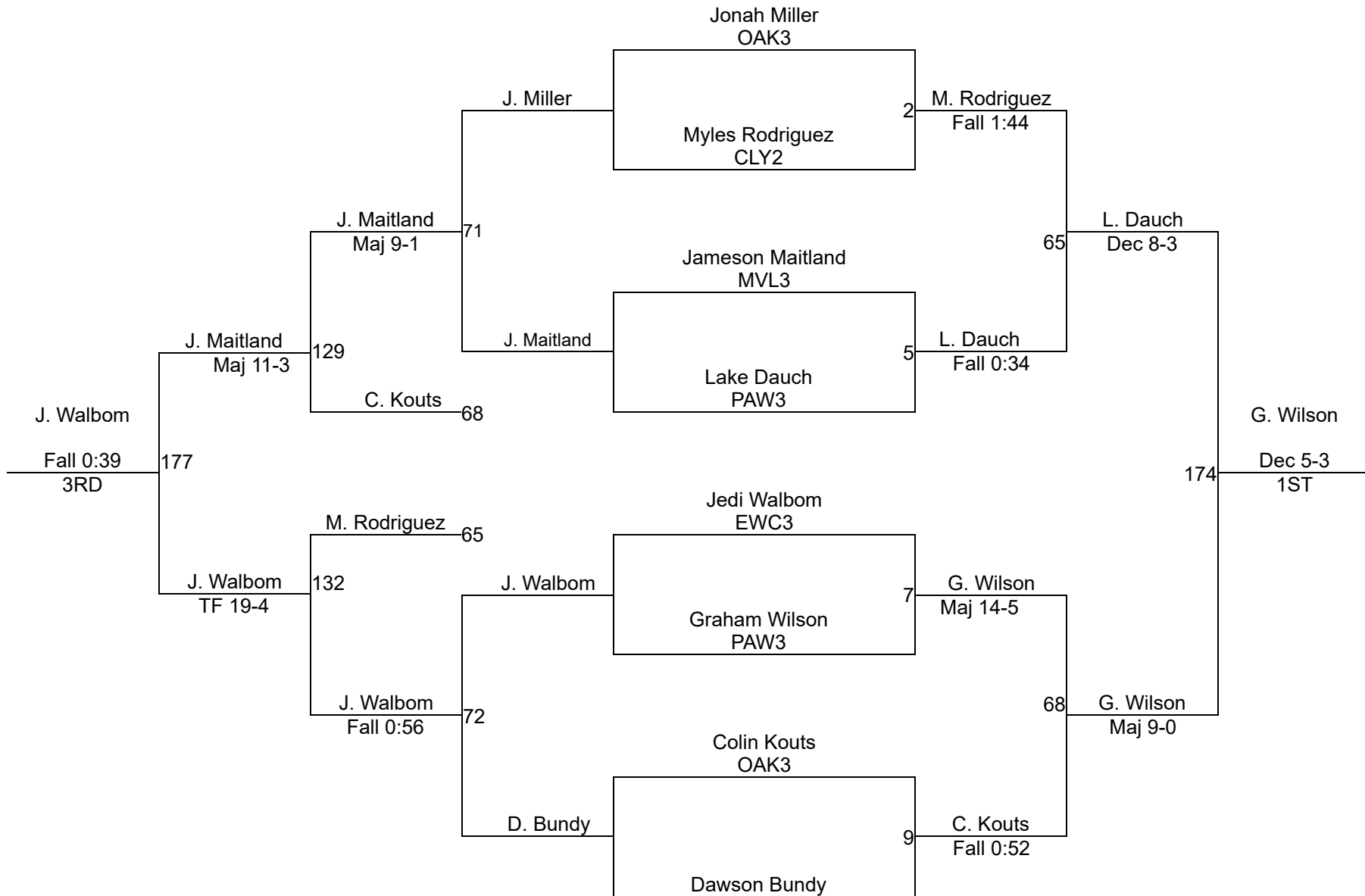

Perkins Pirates Open

Division II Novice 49-53

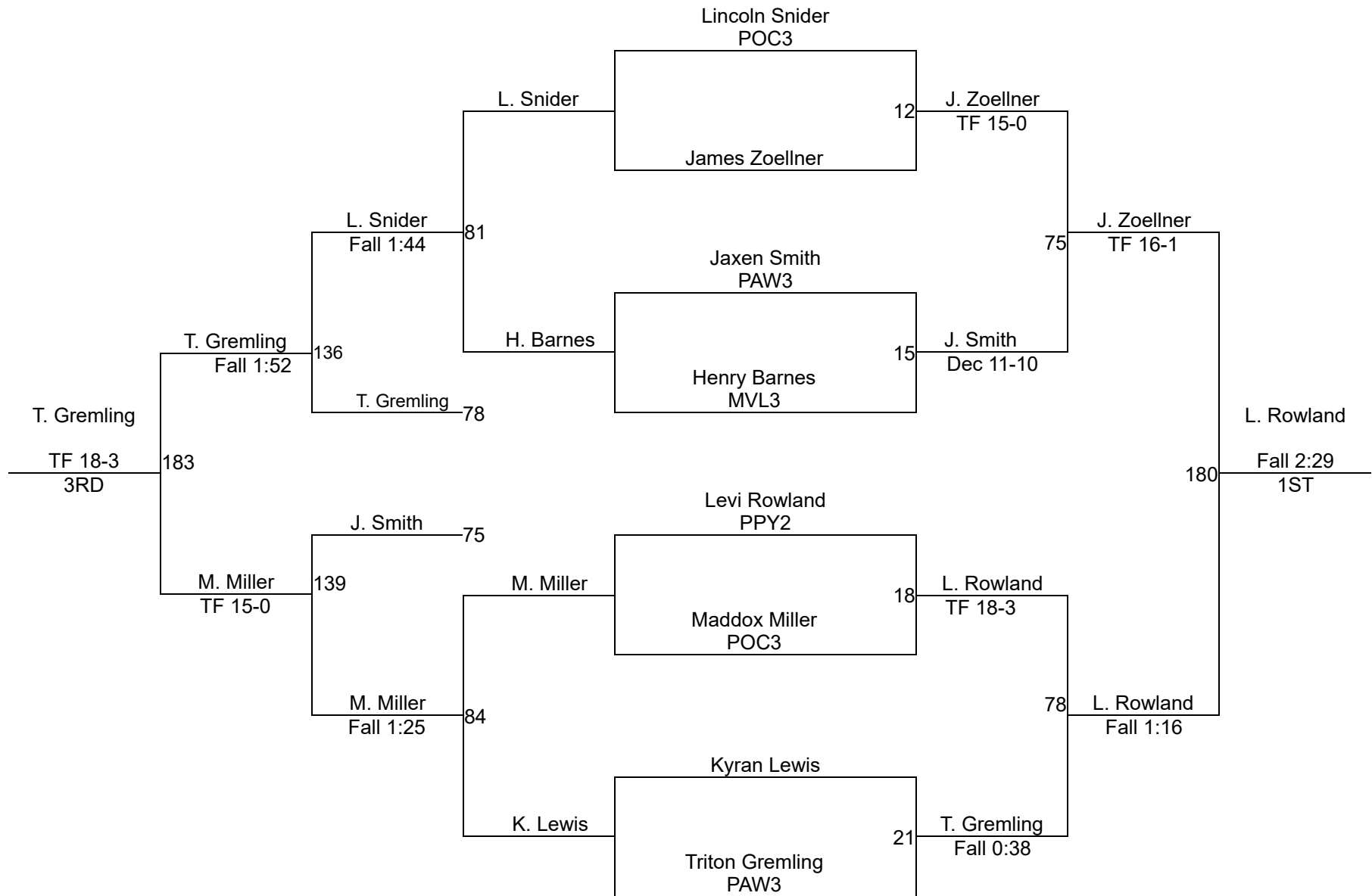

Perkins Pirates Open

Division II Novice 55-59

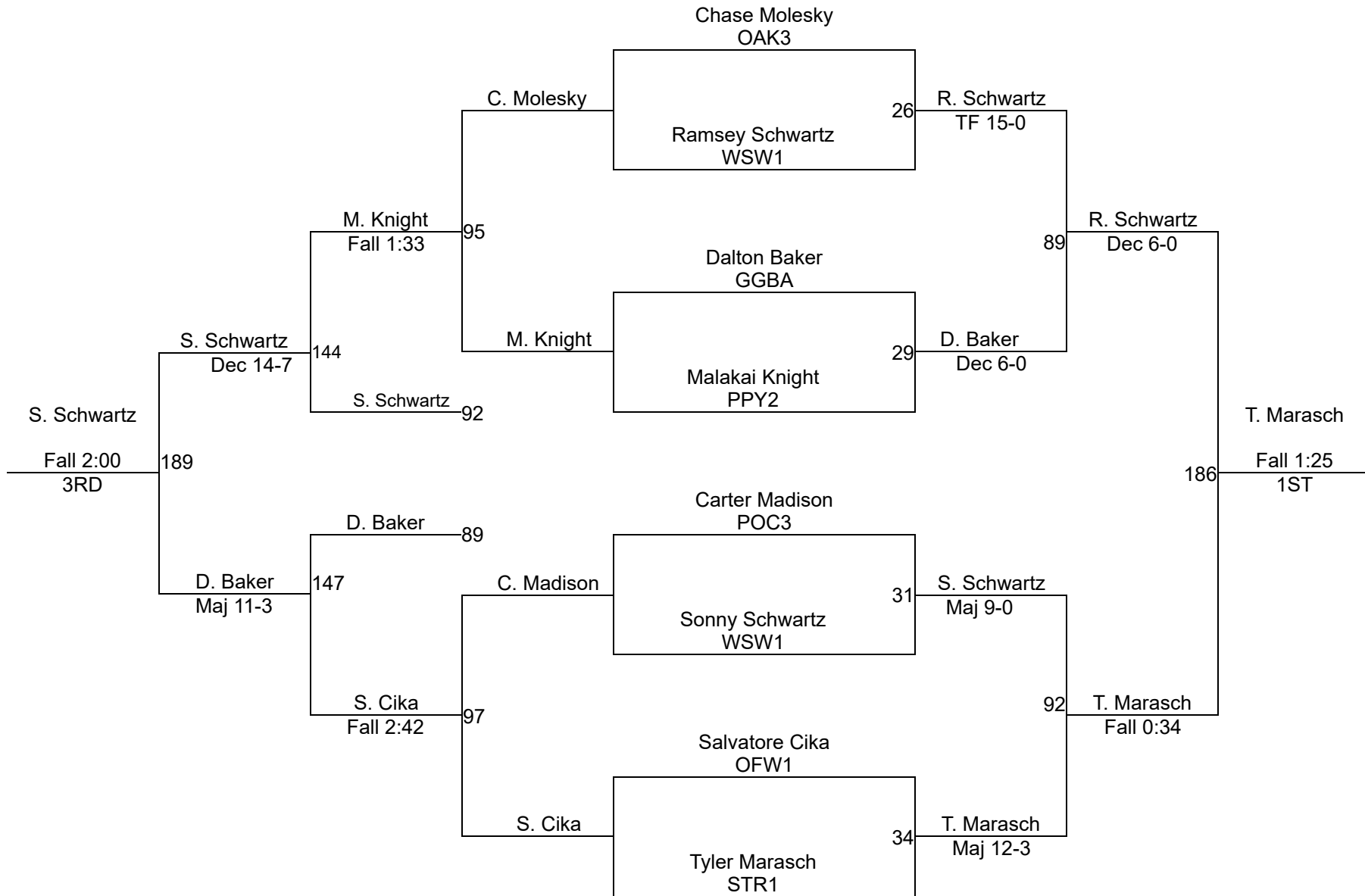

Perkins Pirates Open

Division II Novice 55-65

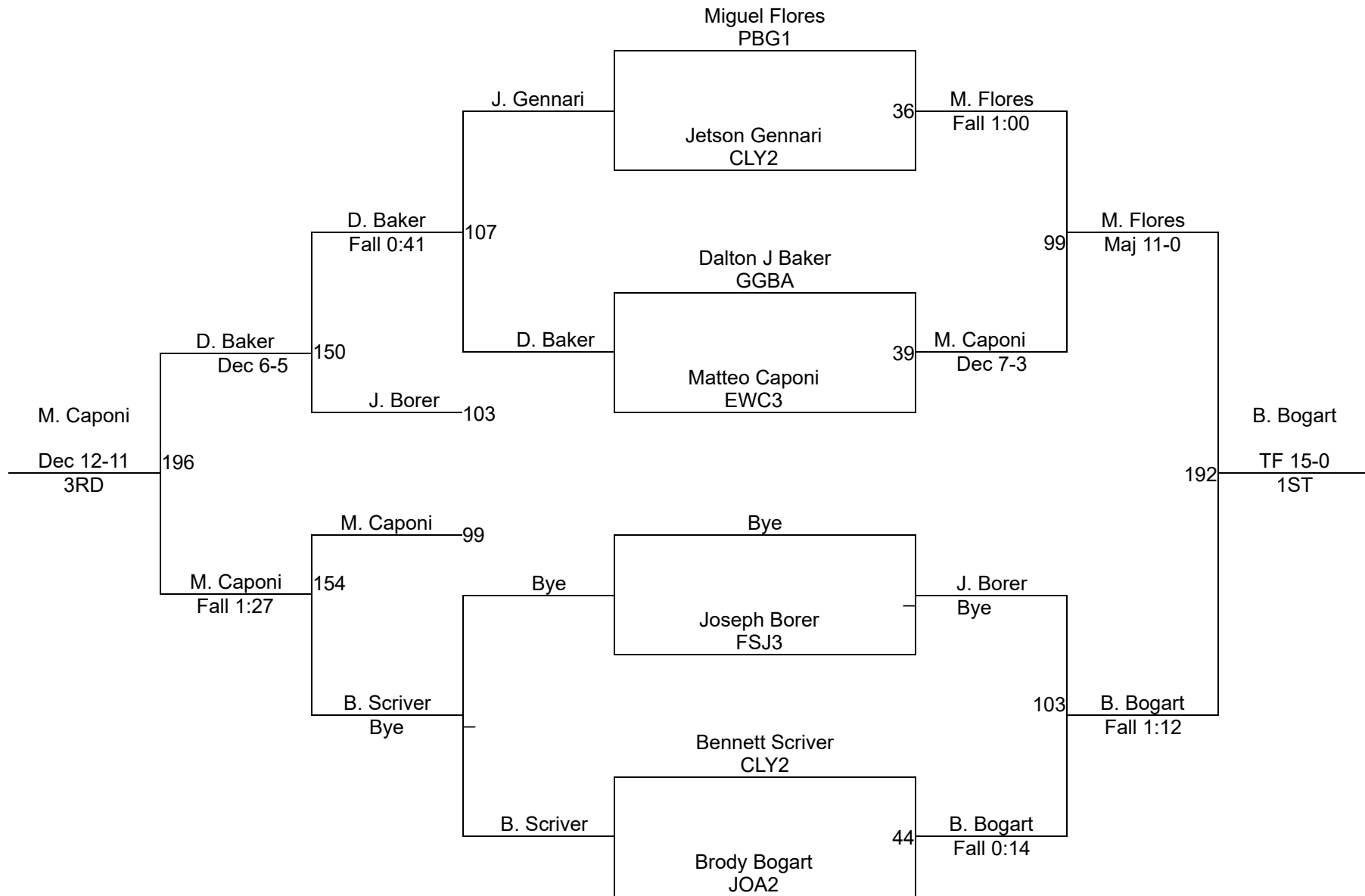

Perkins Pirates Open

Division II Novice 65-73

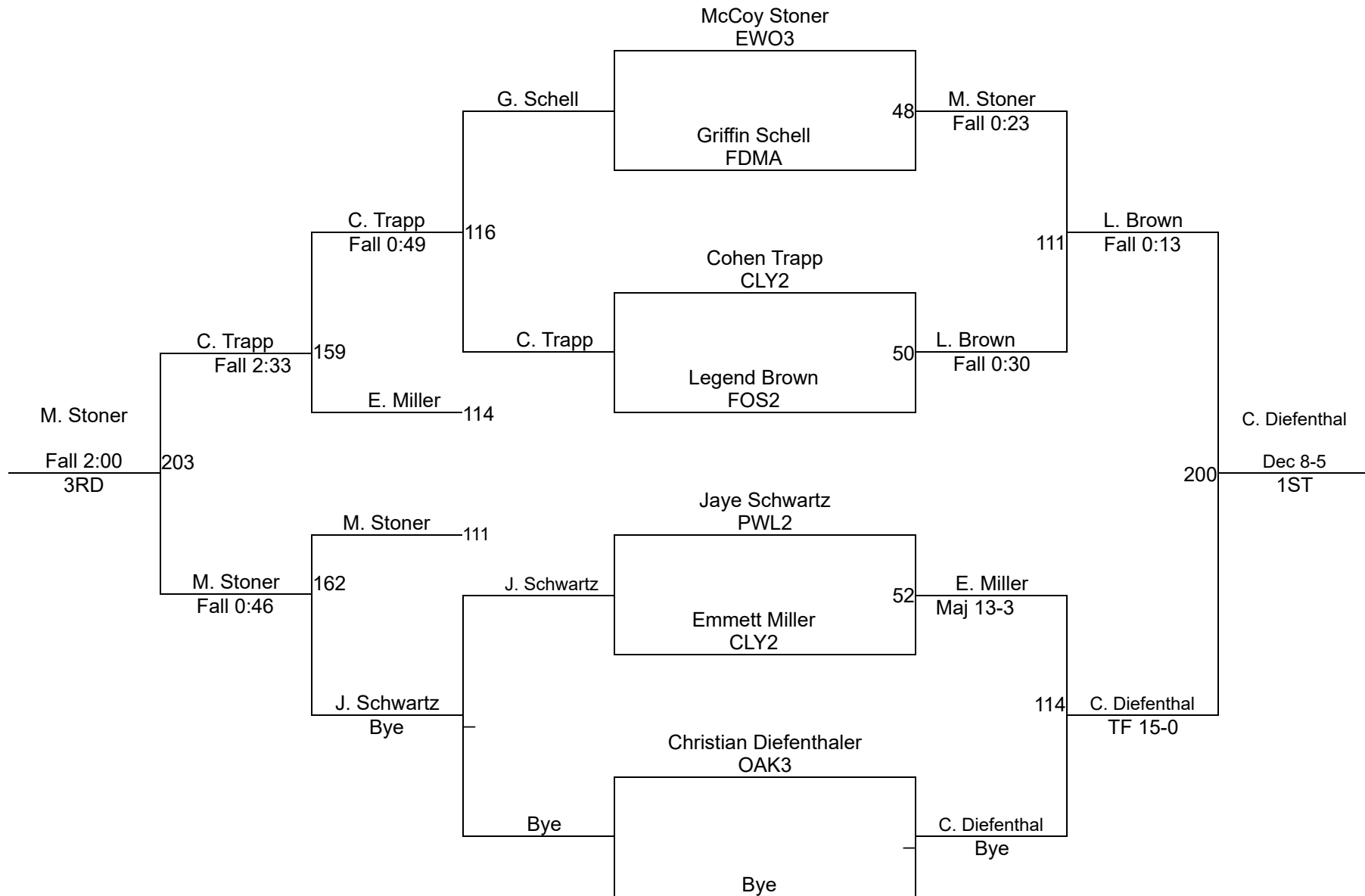

Perkins Pirates Open

Division II Novice 79-88

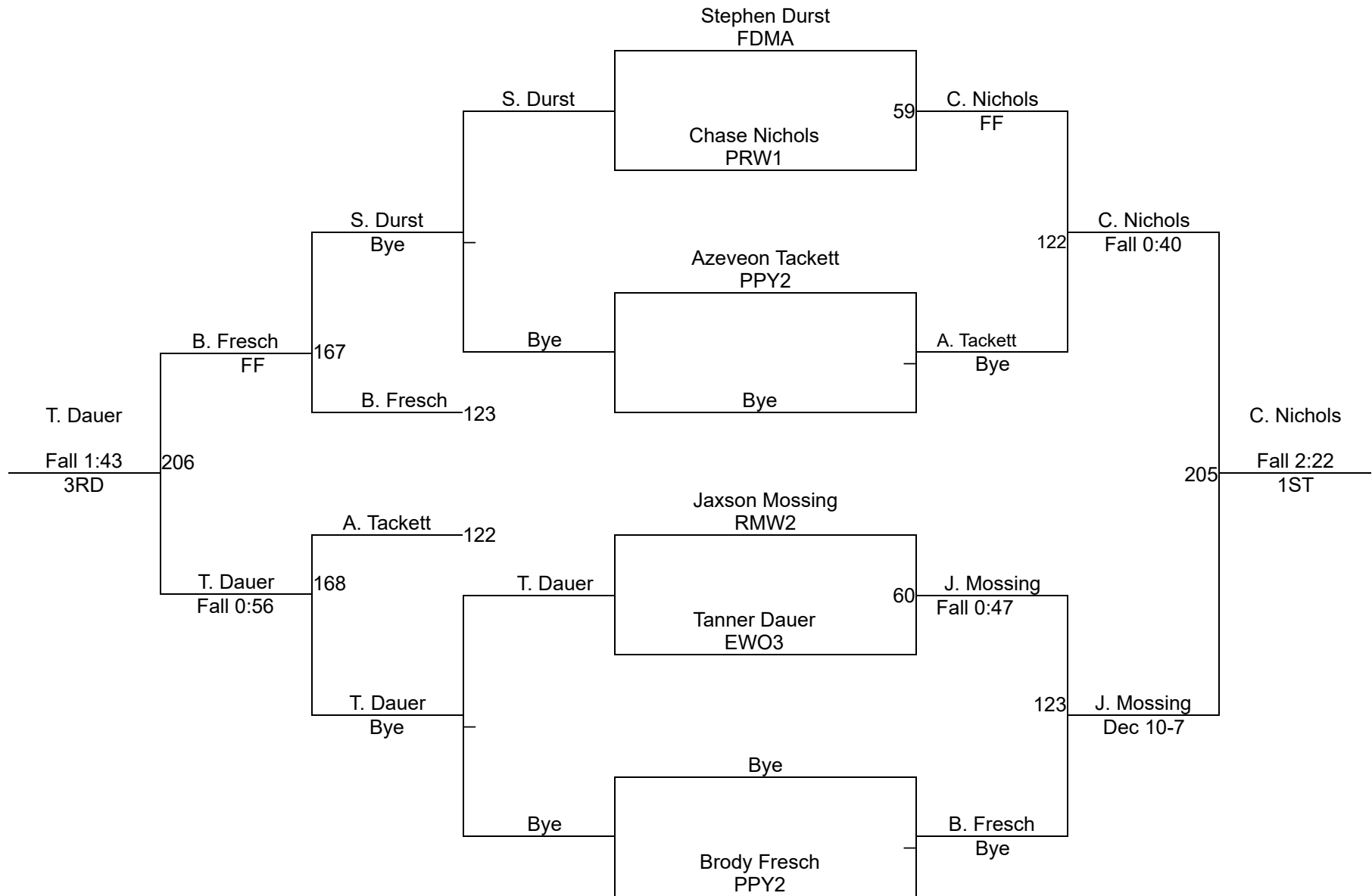

Perkins Pirates Open

Division II Novice 95-105

Round 1

Braxton Blevins PPY2		Braxton Blevins PPY2
	61	Maj 12-3
Arikye Thompson SLW1		

Round 2

Stone Renfro RMW2		Stone Renfro RMW2
	124	Dec 6-0
Arikye Thompson SLW1		

Round 3

Stone Renfro RMW2		Stone Renfro RMW2
	170	Dec 9-6
Braxton Blevins PPY2		

S. Renfro (RMW2)

1ST

B. Blevins (PPY2)

2ND

A. Thompson (SLW1)

3RD

Perkins Pirates Open

Division III Novice 54-60

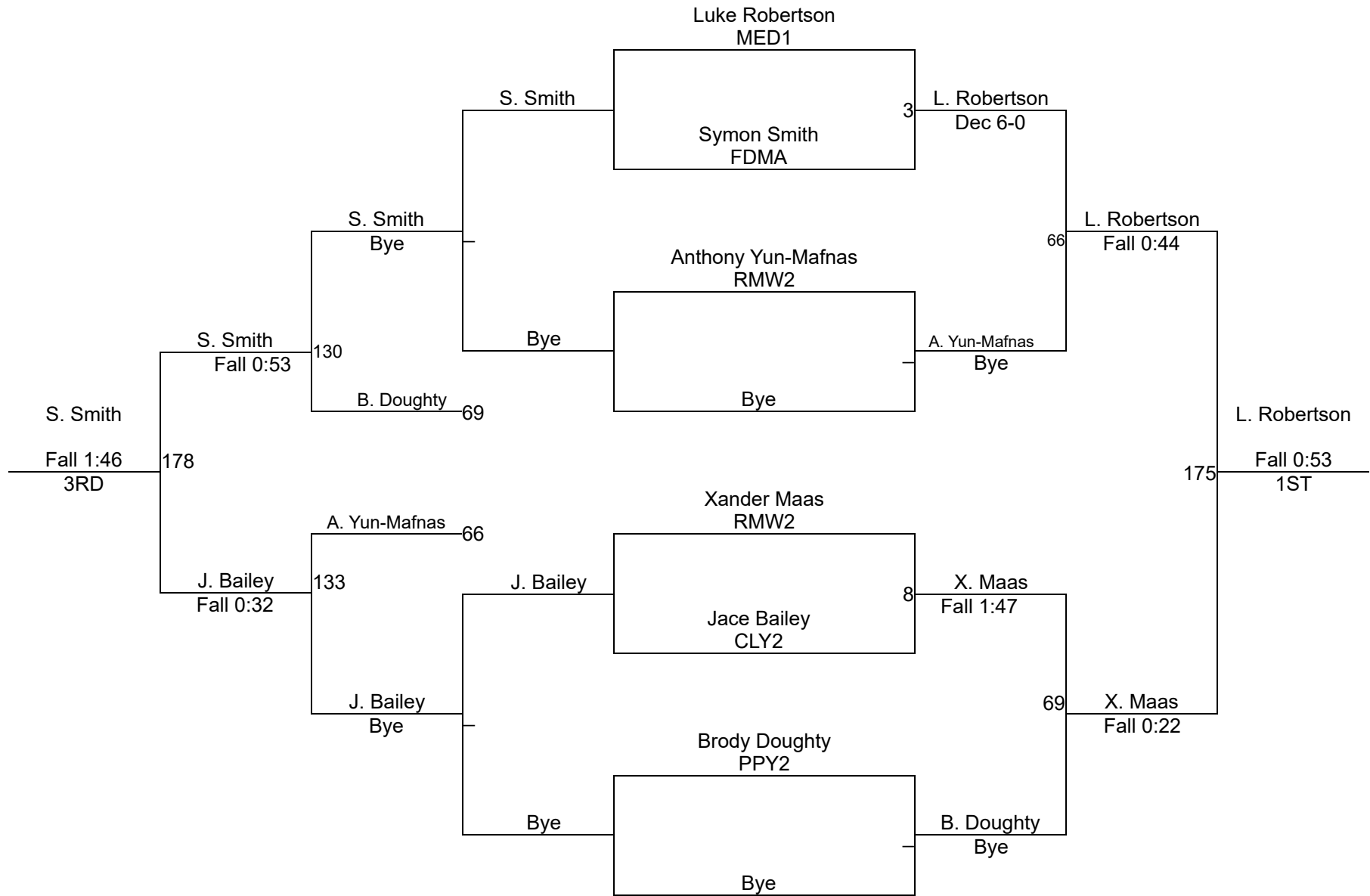

Perkins Pirates Open

Division III Novice 61-65

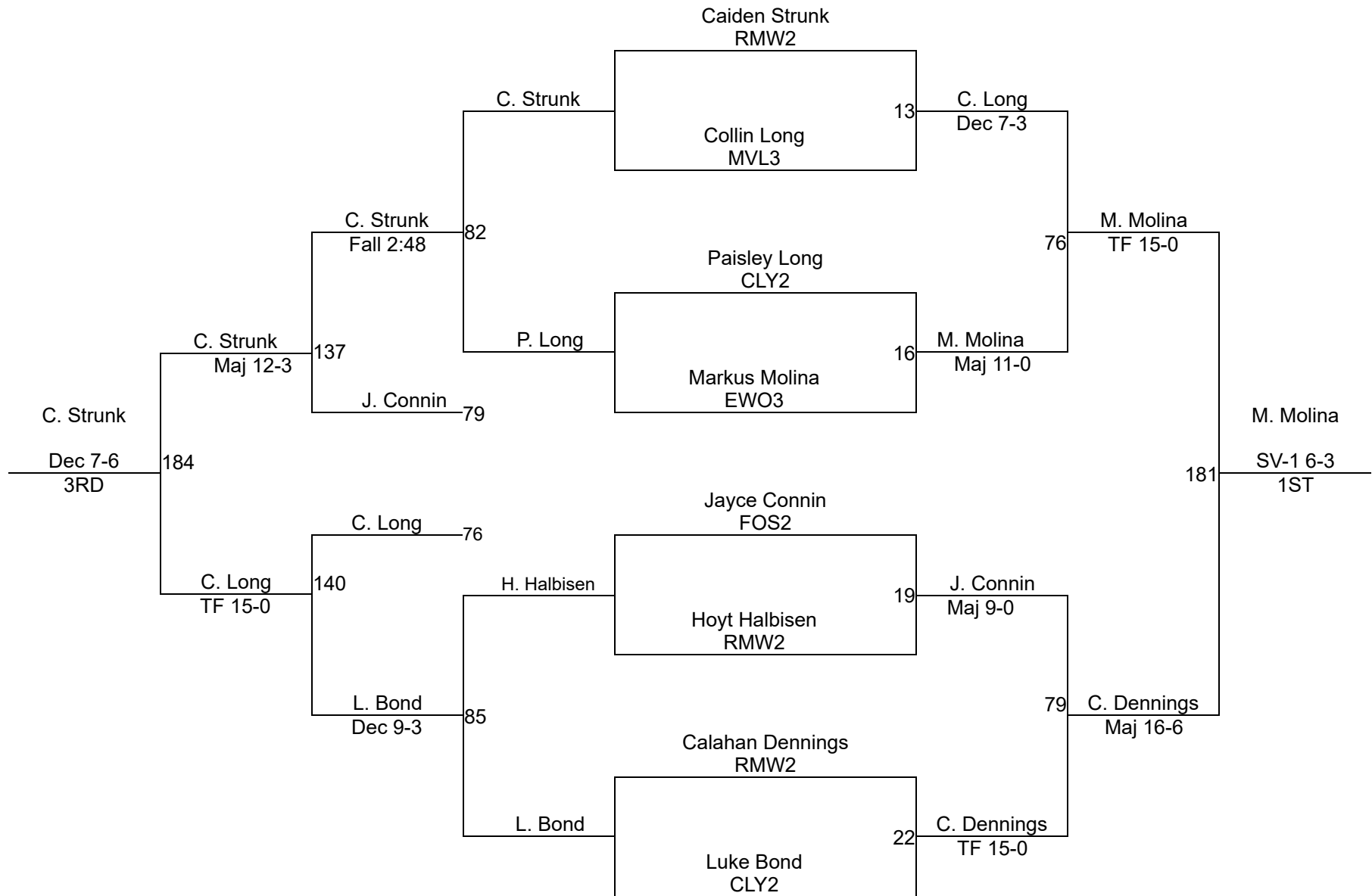

Perkins Pirates Open

Division III Novice 65-68

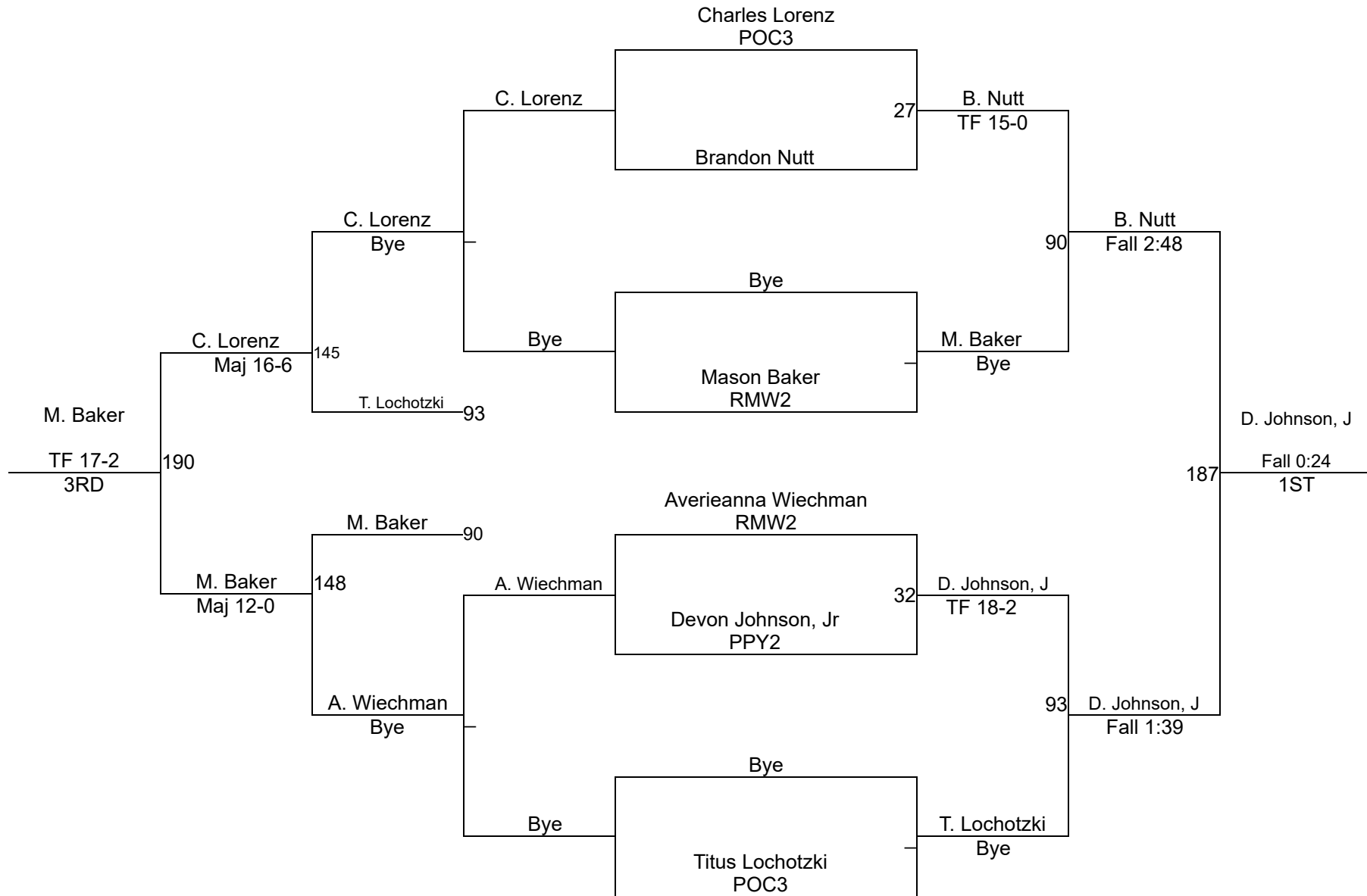

Perkins Pirates Open

Division III Novice 70-75

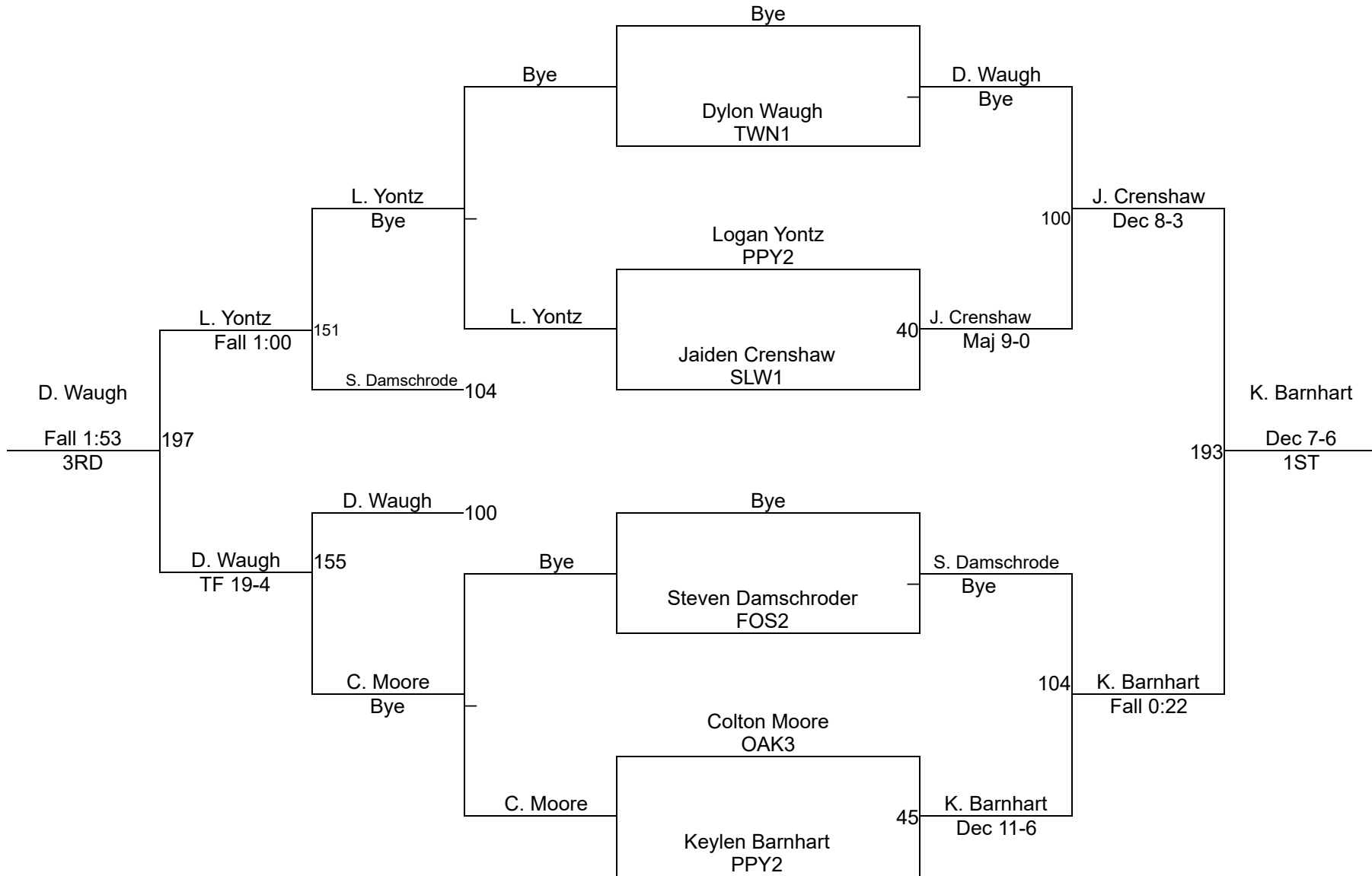

Perkins Pirates Open

Division III Novice 97-113

Round 1

Dayâ??Ana Heitkamp POC3		Ember Schell FDMA
	57	Fall 2:15
Ember Schell FDMA		

Round 2

Robert Stainbrook, Iv FSJ3		Ember Schell FDMA
	120	Maj 13-4
Ember Schell FDMA		

Round 3

Robert Stainbrook, Iv FSJ3		Robert Stainbrook, Iv FSJ3
	165	Dec 10-4
Dayâ??Ana Heitkamp POC3		

E. Schell (FDMA)

1ST

R. Stainbrook, Iv (FSJ3)

2ND

D. Heitkamp (POC3)

3RD

Perkins Pirates Open

Division III Novice 135-139

Round 1

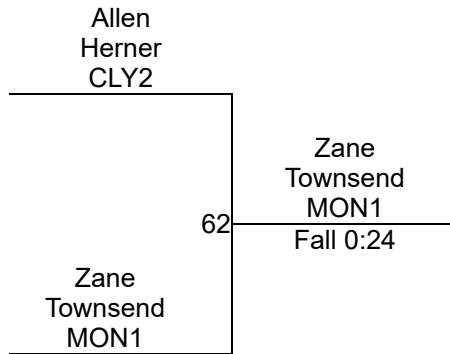

Round 2

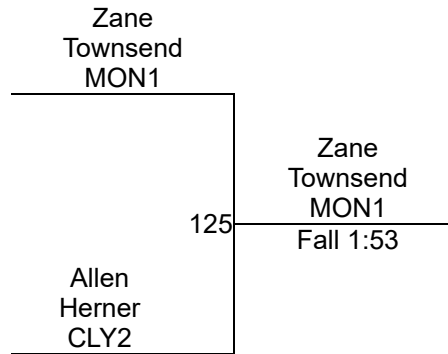

Round 3

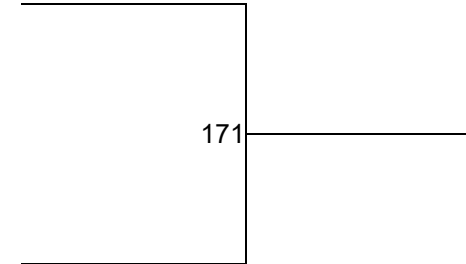

Z. Townsend (MON1)

1ST

A. Herner (CLY2)

2ND

Perkins Pirates Open

Division IV Novice 59-59

Round 1

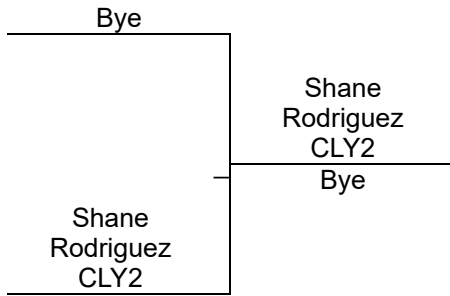

Round 2

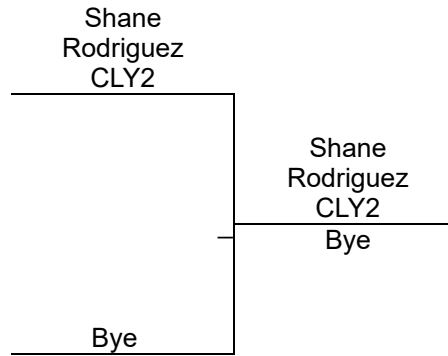

Round 3

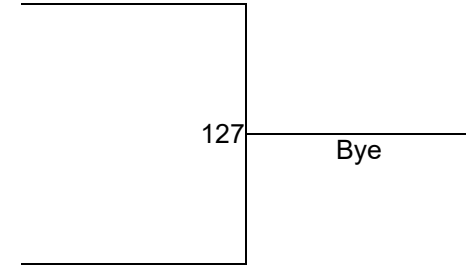

S. Rodriguez (CLY2)
1ST

Bye
2ND

Perkins Pirates Open

Division IV Novice 74-81

Round 1

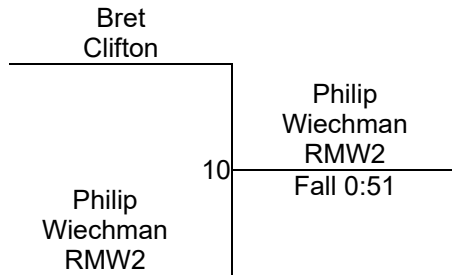

Round 2

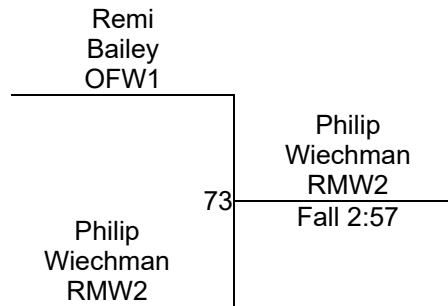

Round 3

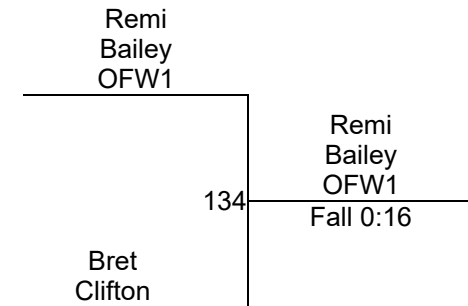

P. Wiechman (RMW2)

1ST

R. Bailey (OFW1)

2ND

B. Clifton ()

3RD

Perkins Pirates Open

Division IV Novice 87-97

Round 1

William Leto, Iv PAW3		William Leto, Iv PAW3
Pirlo Koch JGW2	23	Dec 10-7

Jack Leto PAW3		Cooper Grover SHB1
Cooper Grover SHB1	24	Fall 1:33

Round 2

William Leto, Iv PAW3		Cooper Grover SHB1
Cooper Grover SHB1	86	Dec 6-0

Jack Leto PAW3		Jack Leto PAW3
Pirlo Koch JGW2	87	Fall 0:27

Round 3

William Leto, Iv PAW3		Jack Leto PAW3
Jack Leto PAW3	141	Maj 9-1

Cooper Grover SHB1		Cooper Grover SHB1
Pirlo Koch JGW2	142	TF 17-2

WRESTLERS

W. Leto, Iv (PAW3)

P. Koch (JGW2)

J. Leto (PAW3)

C. Grover (SHB1)

C. Grover (SHB1)

1ST

J. Leto (PAW3)

2ND

W. Leto, Iv (PAW3)

3RD

P. Koch (JGW2)

4TH

Perkins Pirates Open

Division IV Novice 101-110

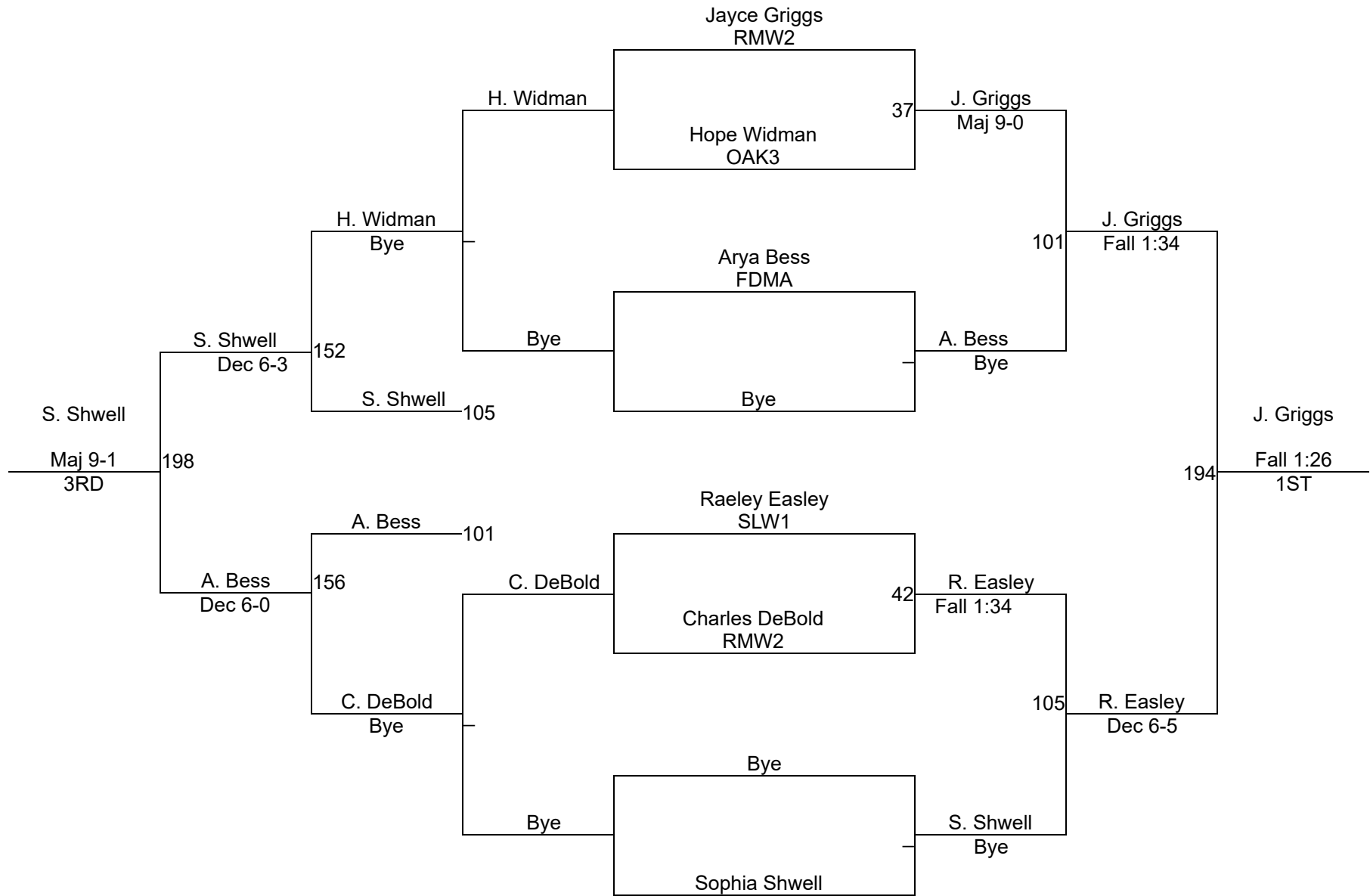

Perkins Pirates Open

Division IV Novice 119-123

Round 1

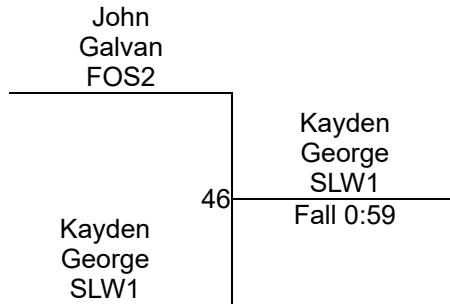

Round 2

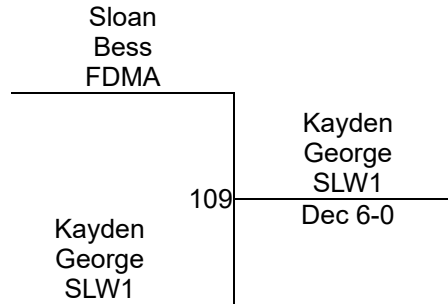

Round 3

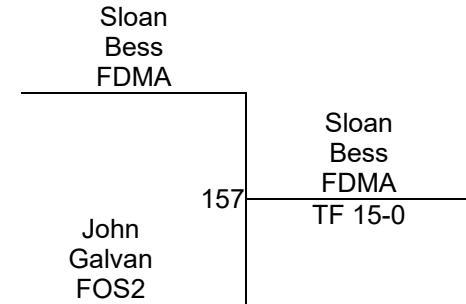

K. George (SLW1)
1ST

S. Bess (FDMA)
2ND

J. Galvan (FOS2)
3RD

Perkins Pirates Open

Division IV Novice 128-143

Round 1

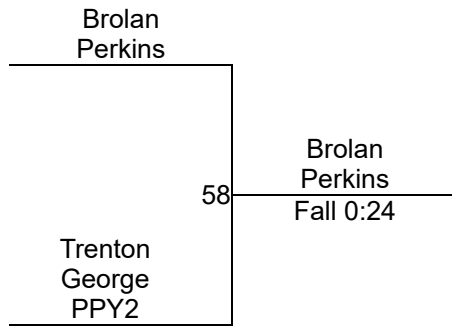

Round 2

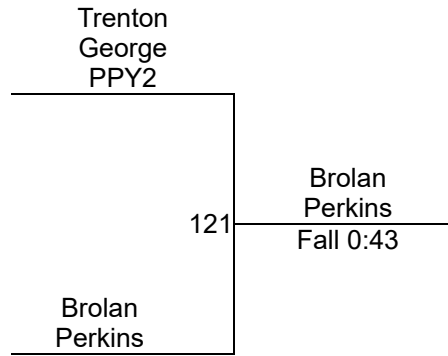

Round 3

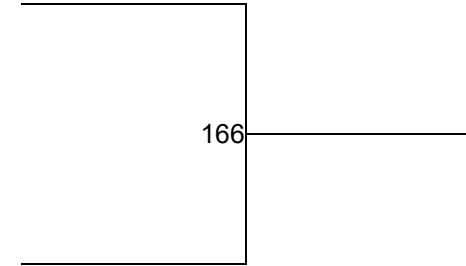

B. Perkins ()

1ST

T. George (PPY2)

2ND

Perkins Pirates Open

Division IV Novice 166-167

Round 1

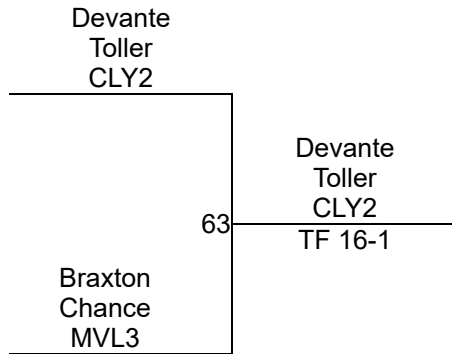

Round 2

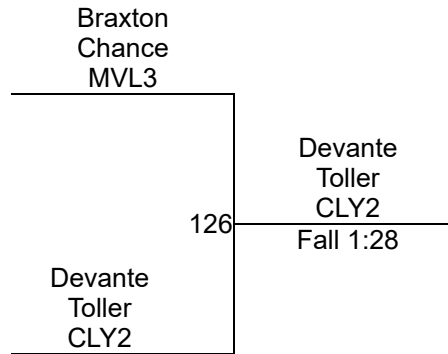

Round 3

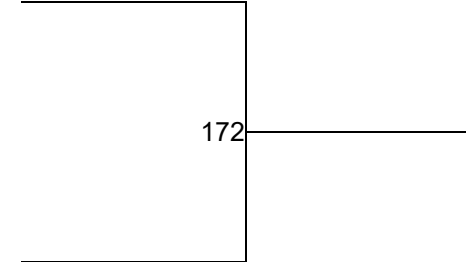

D. Toller (CLY2)

1ST

B. Chance (MVL3)

2ND

Perkins Pirates Open

Division I Open 39-39

Round 1

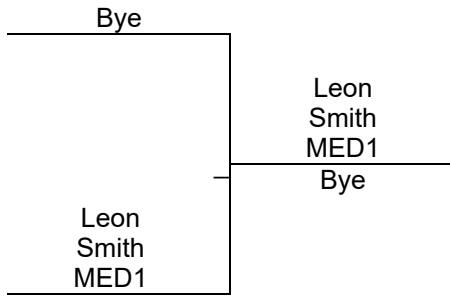

Round 2

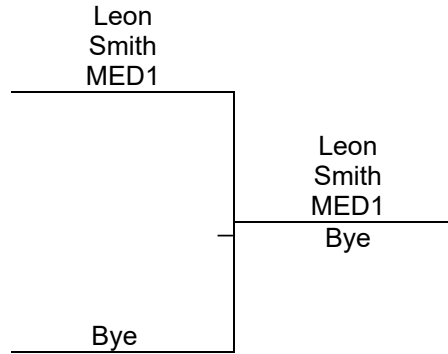

Round 3

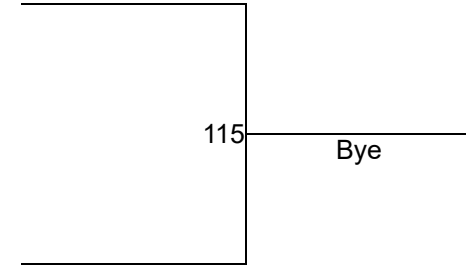

L. Smith (MED1)
1ST

Bye
2ND

Perkins Pirates Open

Division I Open 54-60

Round 1

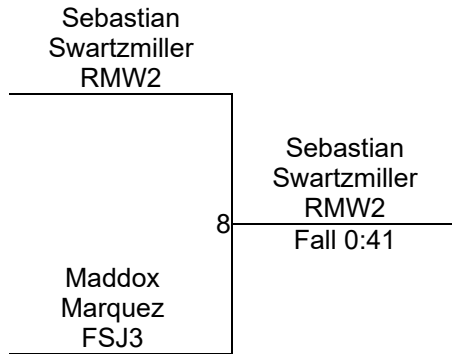

Round 2

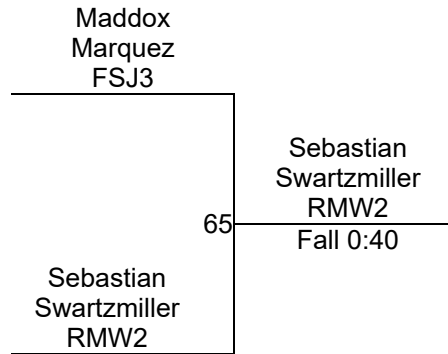

Round 3

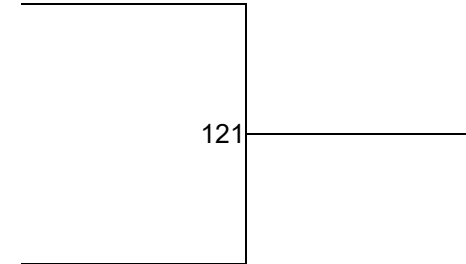

S. Swartzmiller (RMW2)
1ST

M. Marquez (FSJ3)
2ND

Perkins Pirates Open

Division II Open 43-45

Round 1

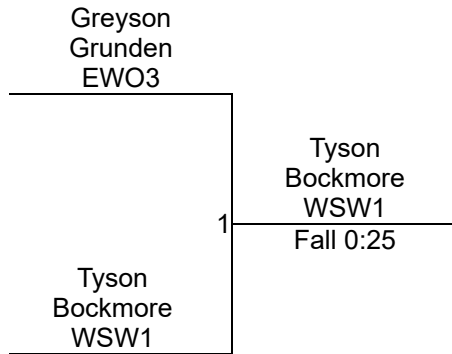

Round 2

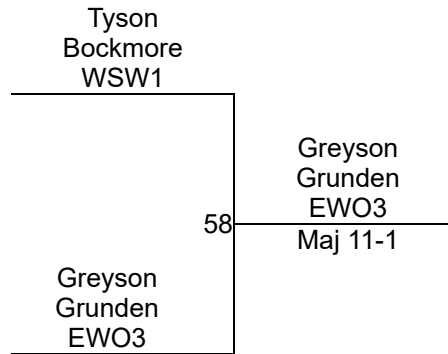

Round 3

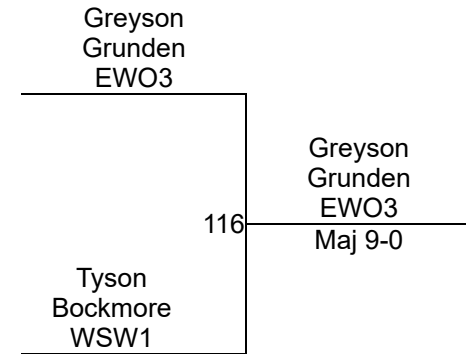

G. Grunden (EWO3)
1ST

T. Bockmore (WSW1)
2ND

Perkins Pirates Open

Division II Open 52-58

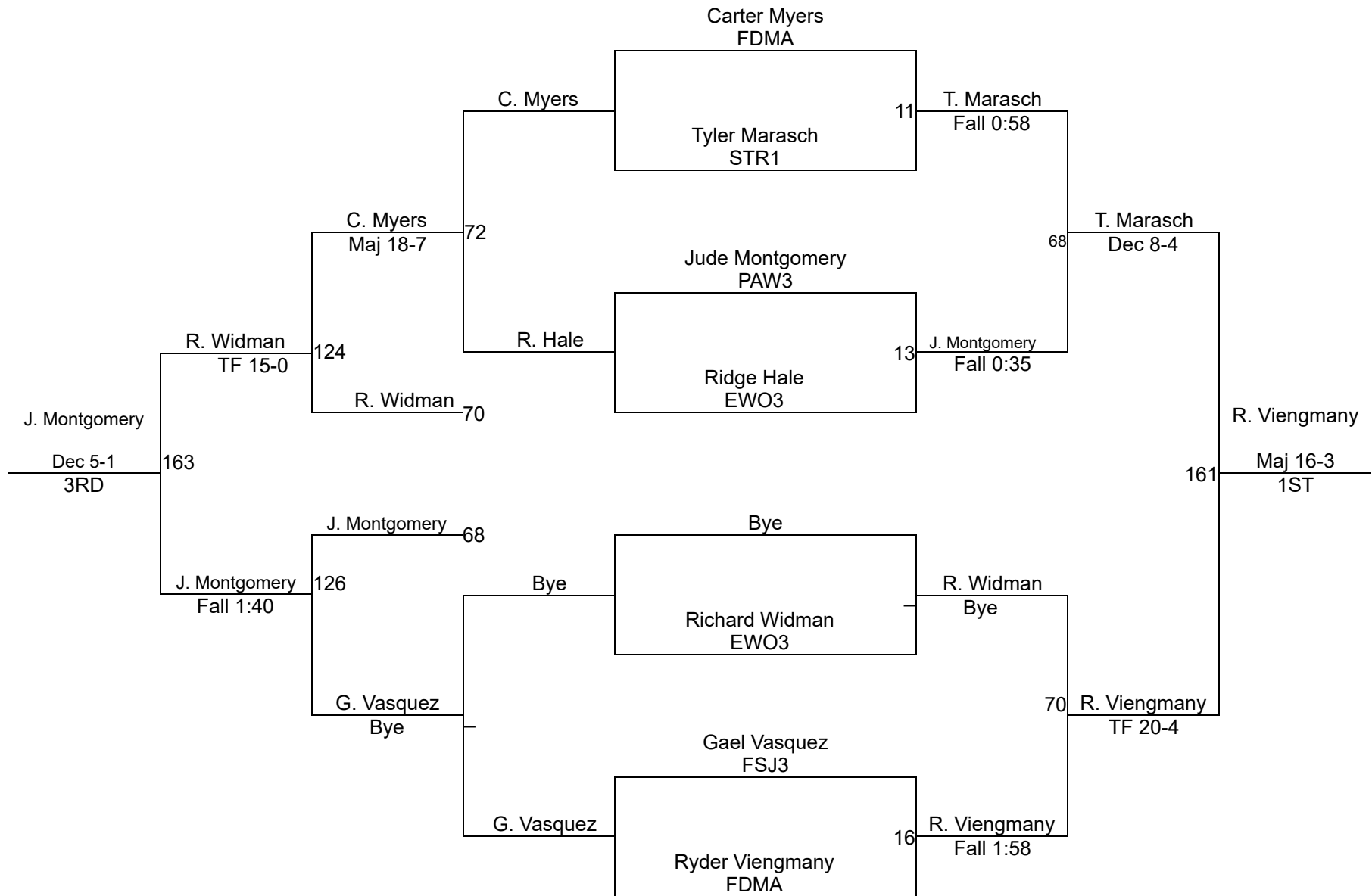

Perkins Pirates Open

Division II Open 59-63

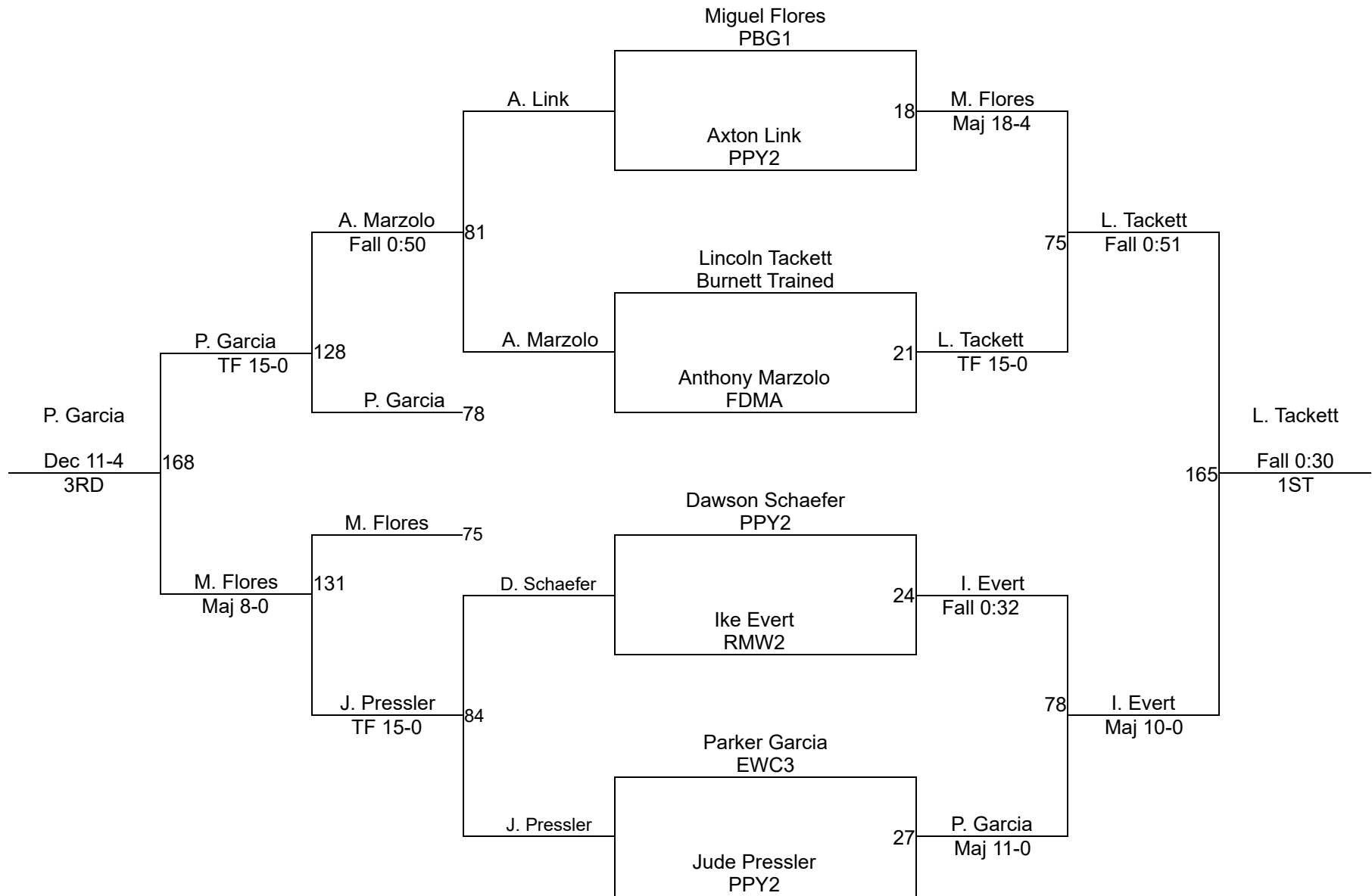

Perkins Pirates Open

Division II Open 64-68

Round 1

Laith Saleh OFW1		Laith Saleh OFW1	
Dalton Howell PAW3	30	TF 15-0	

Braylon Wetzel FDMA		Brody Bogart JOA2	
Brody Bogart JOA2	31	Fall 2:22	

C. Diefenthaler (OAK3)
1ST

Round 2

Christian Diefenthaler OAK3		Christian Diefenthaler OAK3	
Brody Bogart JOA2	87	Dec 13-6	

Laith Saleh OFW1		Laith Saleh OFW1	
Braylon Wetzel FDMA	88	TF 15-0	

B. Bogart (JOA2)
2ND

Round 3

Christian Diefenthaler OAK3		Christian Diefenthaler OAK3	
Braylon Wetzel FDMA	134	Fall 1:16	

Dalton Howell PAW3		Brody Bogart JOA2	
Brody Bogart JOA2	135	Fall 1:00	

L. Saleh (OFW1)
3RD

Round 4

Christian Diefenthaler OAK3		Christian Diefenthaler OAK3	
Dalton Howell PAW3	171	Fall 2:33	

Laith Saleh OFW1		Brody Bogart JOA2	
Brody Bogart JOA2	172	Fall 1:31	

B. Wetzel (FDMA)
4TH

Round 5

Christian Diefenthaler OAK3		Christian Diefenthaler OAK3	
Laith Saleh OFW1	189	Dec 7-6	

Dalton Howell PAW3		Braylon Wetzel FDMA	
Braylon Wetzel FDMA	190	Maj 10-2	

D. Howell (PAW3)
5TH

Perkins Pirates Open

Division II Open 66-74

Round 1

Taylor Schrock ARC3		Taylor Schrock ARC3	
Colton Marett EWC3	40	TF 15-0	

Legend Brown FOS2		Legend Brown FOS2	
Mavric James PAW3	41	SV-1 17-12	

T. Schrock (ARC3)
1ST

Round 2

Ryan Gahler OAK3		Mavric James PAW3	
Mavric James PAW3	97	Dec 9-8	

Taylor Schrock ARC3		Taylor Schrock ARC3	
Legend Brown FOS2	98	Dec 11-9	

L. Brown (FOS2)
2ND

Round 3

Ryan Gahler OAK3		Ryan Gahler OAK3	
Legend Brown FOS2	140	Dec 11-7	

Colton Marett EWC3		Mavric James PAW3	
Mavric James PAW3	141	Dec 8-1	

M. James (PAW3)
3RD

Round 4

Ryan Gahler OAK3		Ryan Gahler OAK3	
Colton Marett EWC3	177	Dec 11-6	

Taylor Schrock ARC3		Taylor Schrock ARC3	
Mavric James PAW3	178	Fall 2:31	

R. Gahler (OAK3)
4TH

Round 5

Ryan Gahler OAK3		Taylor Schrock ARC3	
Taylor Schrock ARC3	191	Fall 2:00	

Colton Marett EWC3		Legend Brown FOS2	
Legend Brown FOS2	192	SV-1 11-8	

C. Marett (EWC3)
5TH

Perkins Pirates Open

Division II Open 85-102

Round 1

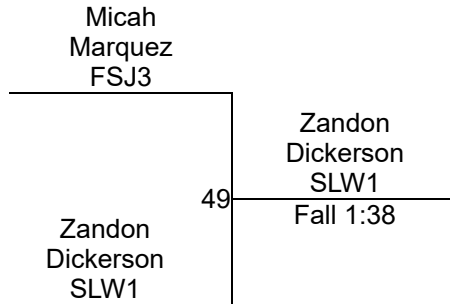

Round 2

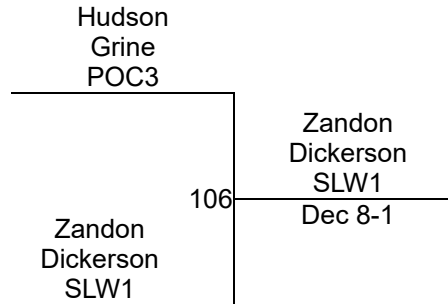

Round 3

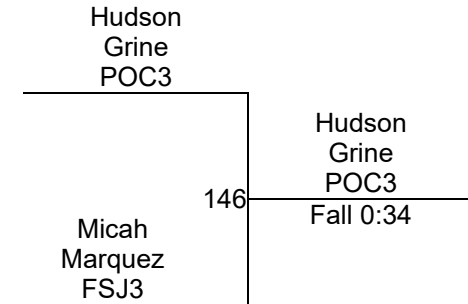

Z. Dickerson (SLW1)

1ST

H. Grine (POC3)

2ND

M. Marquez (FSJ3)

3RD

Perkins Pirates Open

Division III Open 51-57

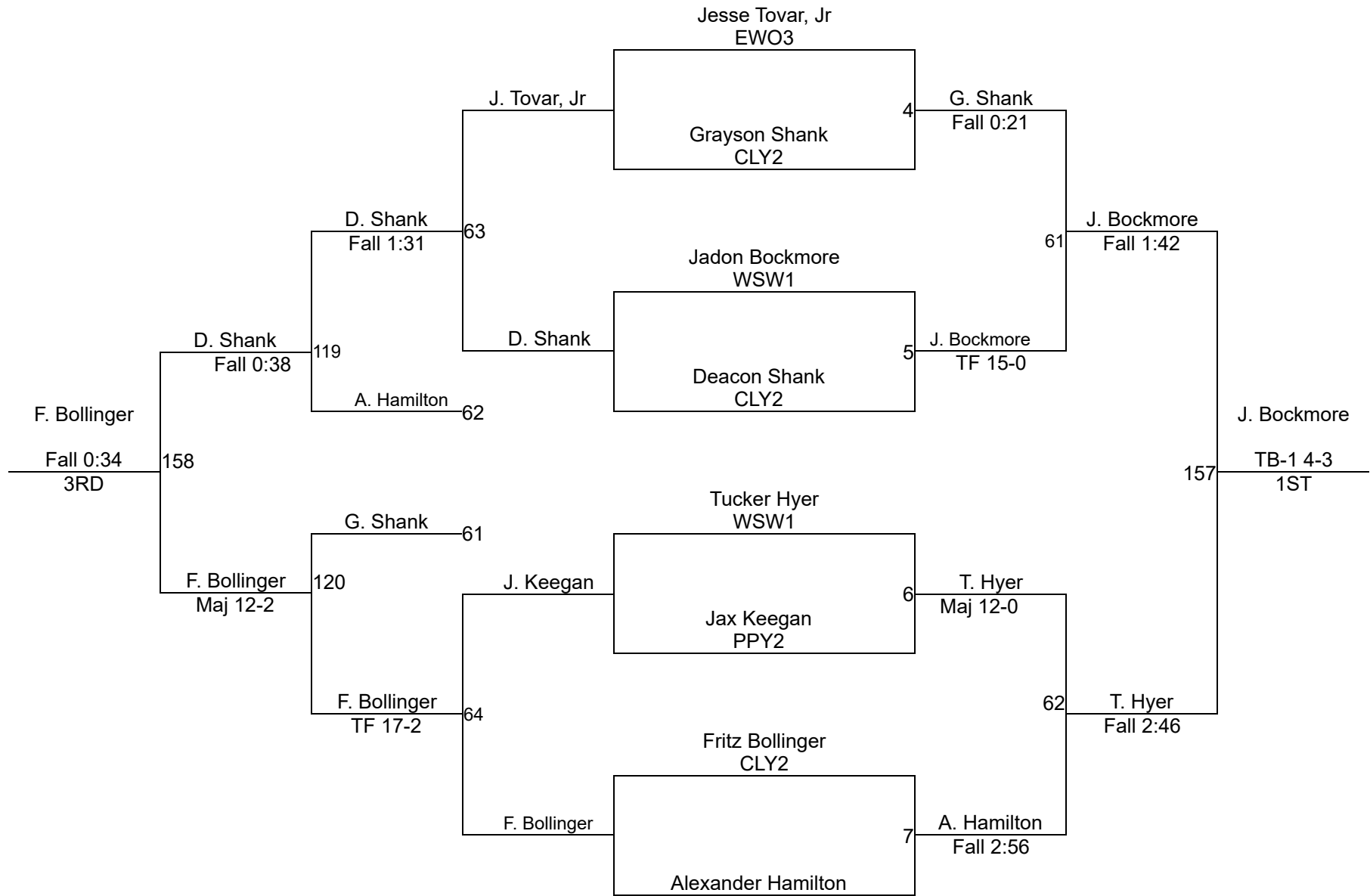

Perkins Pirates Open

Division III Open 63-71

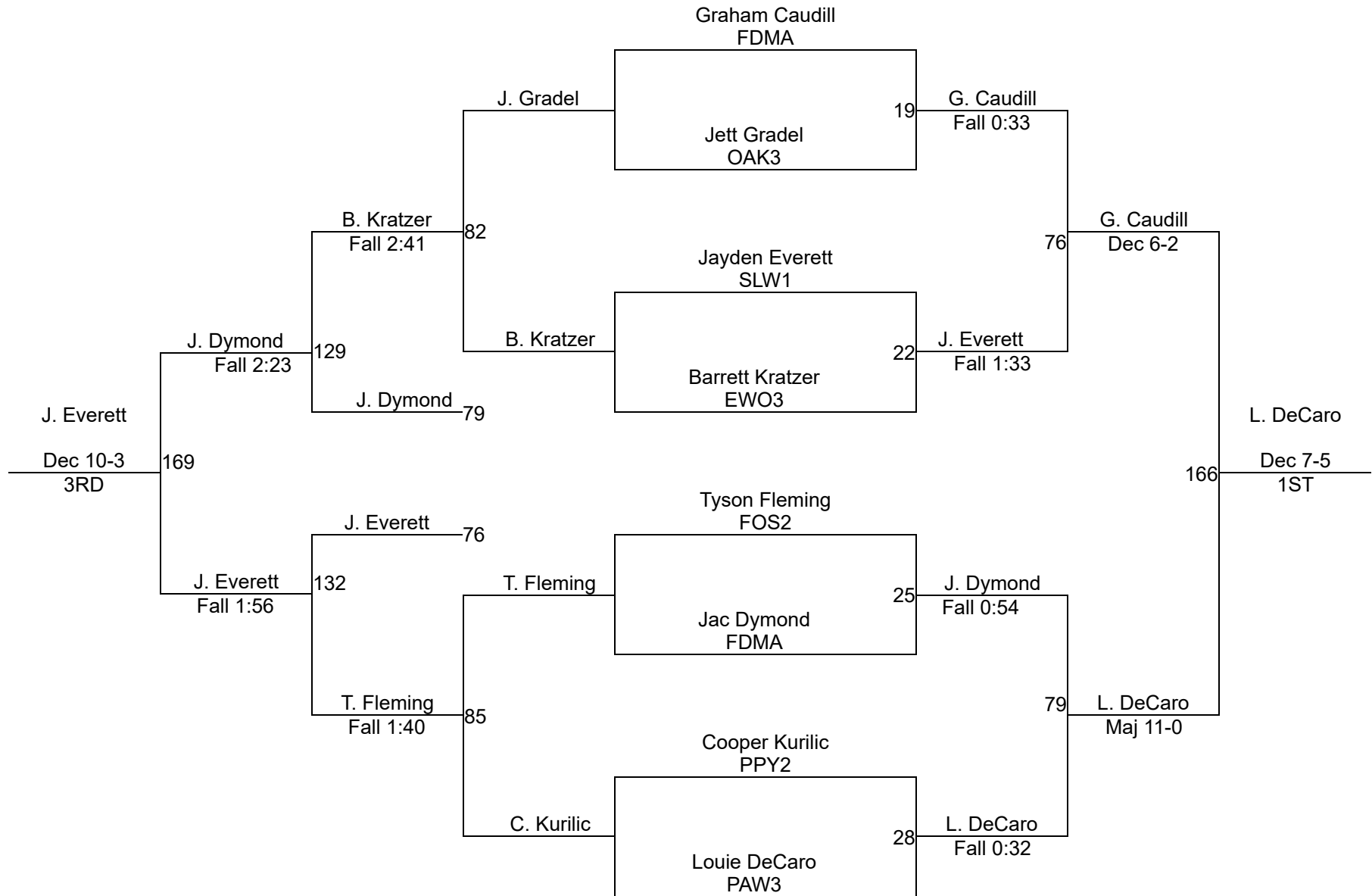

Perkins Pirates Open

Division III Open 77-81

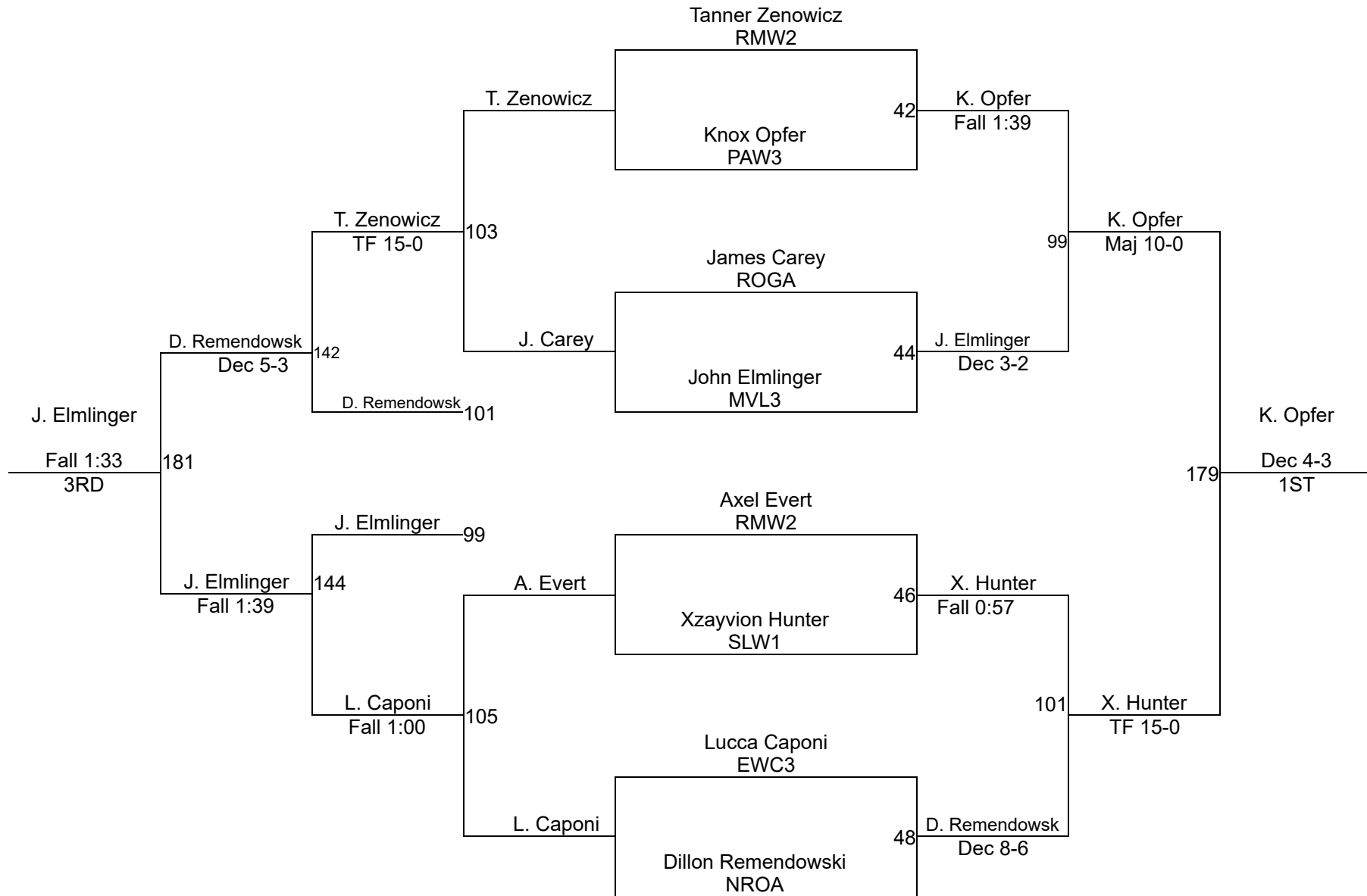

Perkins Pirates Open

Division III Open 82-93

Round 1

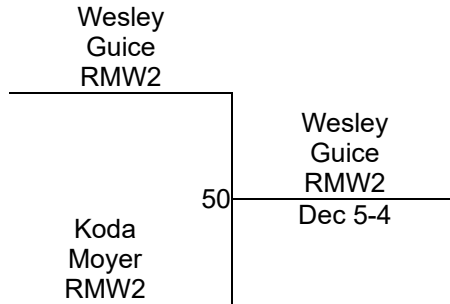

Round 2

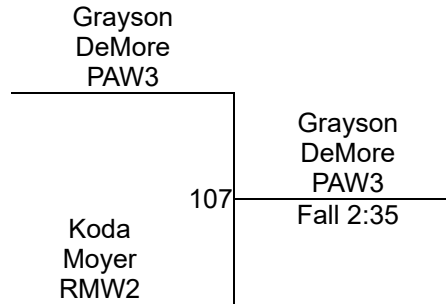

Round 3

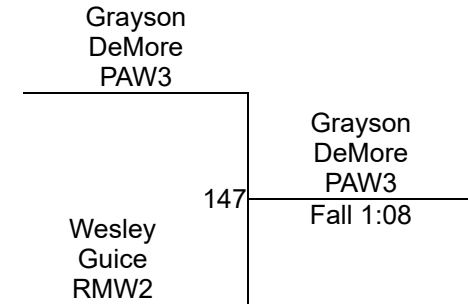

G. DeMore (PAW3)
1ST

W. Guice (RMW2)
2ND

K. Moyer (RMW2)
3RD

Perkins Pirates Open

Division III Open 94-106

Round 1

Jameson Gilles WSW1		Jameson Gilles WSW1
Liam Fraley PPY2	52	Fall 1:26

Maverick Manrow EWC3		Henry Schwartz FDMA
Henry Schwartz FDMA	54	Fall 2:33

Round 2

Jameson Gilles WSW1		Henry Schwartz FDMA
Henry Schwartz FDMA	109	Maj 9-0

Maverick Manrow EWC3		Maverick Manrow EWC3
Liam Fraley PPY2	111	Fall 0:31

Round 3

Jameson Gilles WSW1		Maverick Manrow EWC3
Maverick Manrow EWC3	149	Fall 2:24

Henry Schwartz FDMA		Henry Schwartz FDMA
Liam Fraley PPY2	151	Fall 0:59

WRESTLERS

- J. Gilles (WSW1)
- L. Fraley (PPY2)
- M. Manrow (EWC3)
- H. Schwartz (FDMA)

H. Schwartz (FDMA)
1ST

M. Manrow (EWC3)
2ND

J. Gilles (WSW1)
3RD

L. Fraley (PPY2)
4TH

Perkins Pirates Open

Division III Open 109-117

Round 1

Andrew Wilson SHB1	Andrew Wilson SHB1
John Bremke	Fall 2:19
56	

Zyonnie Rodriguez EMPA	Zayvier Dickerson, Jr SLW1
Zayvier Dickerson, Jr SLW1	Fall 0:46
57	

Z. Dickerson, Jr (SLW1)
1ST

Round 2

Bradley Hay MVL3	Zayvier Dickerson, Jr SLW1
Zayvier Dickerson, Jr SLW1	Fall 0:55
113	

Andrew Wilson SHB1	Andrew Wilson SHB1
Zyonnie Rodriguez EMPA	Fall 2:27
114	

A. Wilson (SHB1)
2ND

Round 3

Bradley Hay MVL3	Zyonnie Rodriguez EMPA
Zyonnie Rodriguez EMPA	TF 15-0
153	

John Bremke	Zayvier Dickerson, Jr SLW1
Zayvier Dickerson, Jr SLW1	TF 15-0
154	

Z. Rodriguez (EMPA)
3RD

Round 4

Bradley Hay MVL3	Bradley Hay MVL3
John Bremke	Maj 10-0
183	

Andrew Wilson SHB1	Zayvier Dickerson, Jr SLW1
Zayvier Dickerson, Jr SLW1	Fall 1:58
184	

B. Hay (MVL3)
4TH

Round 5

Bradley Hay MVL3	Andrew Wilson SHB1
Andrew Wilson SHB1	Dec 6-0
193	

John Bremke	Zyonnie Rodriguez EMPA
Zyonnie Rodriguez EMPA	Fall 0:31
194	

J. Bremke ()
5TH

Perkins Pirates Open

Division IV Open 59-65

Round 1

Trae Dauch PAW3	Eli Montgomery PAW3 Maj 8-0
Eli Montgomery PAW3	2

Miller Burdette EWO3	Miller Burdette EWO3 TF 16-1
Athena Eads FDMA	3

E. Montgomery (PAW3)
1ST

Round 2

Shane Rodriguez CLY2	Shane Rodriguez CLY2 Fall 2:33
Athena Eads FDMA	59

Trae Dauch PAW3	Miller Burdette EWO3 TF 18-3
Miller Burdette EWO3	60

M. Burdette (EWO3)
2ND

Round 3

Shane Rodriguez CLY2	Miller Burdette EWO3 Fall 0:48
Miller Burdette EWO3	117

Eli Montgomery PAW3	Eli Montgomery PAW3 Fall 0:25
Athena Eads FDMA	118

T. Dauch (PAW3)
3RD

Round 4

Shane Rodriguez CLY2	Eli Montgomery PAW3 Fall 0:26
Eli Montgomery PAW3	155

Trae Dauch PAW3	Trae Dauch PAW3 Fall 0:16
Athena Eads FDMA	156

S. Rodriguez (CLY2)
4TH

Round 5

Shane Rodriguez CLY2	Trae Dauch PAW3 Fall 0:45
Trae Dauch PAW3	185

Eli Montgomery PAW3	Eli Montgomery PAW3 Dec 1-0
Miller Burdette EWO3	186

A. Eads (FDMA)
5TH

Perkins Pirates Open

Division IV Open 70-74

Round 1

Nolan Parrish MVL1		Nolan Parrish MVL1	
Michael McGrath FDMA	9	Dec 9-6	

Breccan Kellogg PWCA		Breccan Kellogg PWCA	
Jaiden Gamble SLW1	10	Dec 5-3	

B. Kellogg (PWCA)
1ST

Round 2

Dominick Borjas OAK3		Jaiden Gamble SLW1	
Jaiden Gamble SLW1	66	TF 17-0	

Nolan Parrish MVL1		Breccan Kellogg PWCA	
Breccan Kellogg PWCA	67	Dec 7-2	

J. Gamble (SLW1)
2ND

Round 3

Dominick Borjas OAK3		Breccan Kellogg PWCA	
Breccan Kellogg PWCA	122	Fall 1:38	

Michael McGrath FDMA		Jaiden Gamble SLW1	
Jaiden Gamble SLW1	123	Fall 2:05	

D. Borjas (OAK3)
3RD

Round 4

Dominick Borjas OAK3		Dominick Borjas OAK3	
Michael McGrath FDMA	159	Fall 0:38	

Nolan Parrish MVL1		Jaiden Gamble SLW1	
Jaiden Gamble SLW1	160	TF 19-4	

N. Parrish (MVL1)
4TH

Round 5

Dominick Borjas OAK3		Dominick Borjas OAK3	
Nolan Parrish MVL1	187	FF	

Michael McGrath FDMA		Breccan Kellogg PWCA	
Breccan Kellogg PWCA	188	TF 17-2	

M. McGrath (FDMA)
5TH

Perkins Pirates Open

Division IV Open 79-85

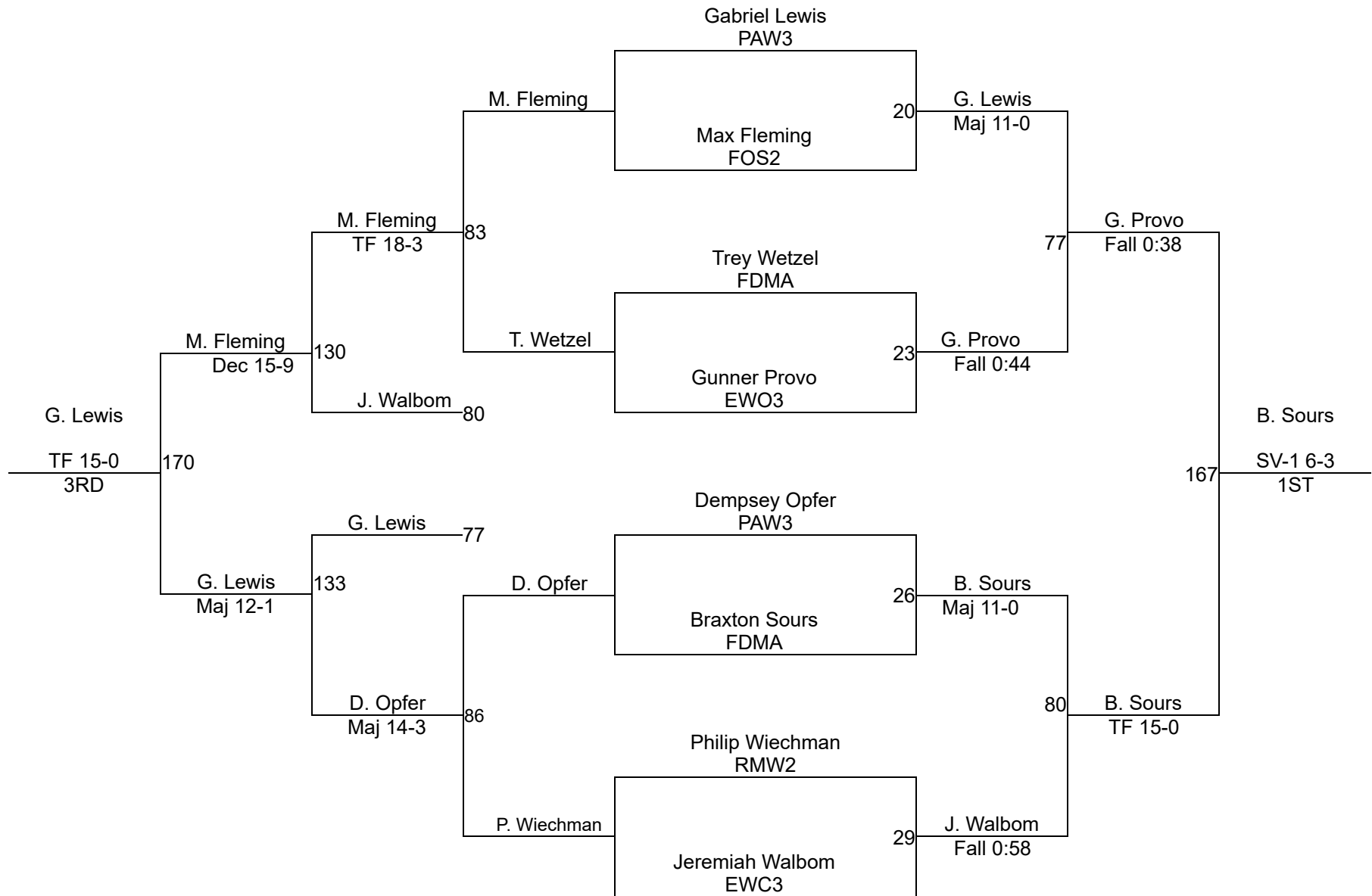

Perkins Pirates Open

Division IV Open 85-94

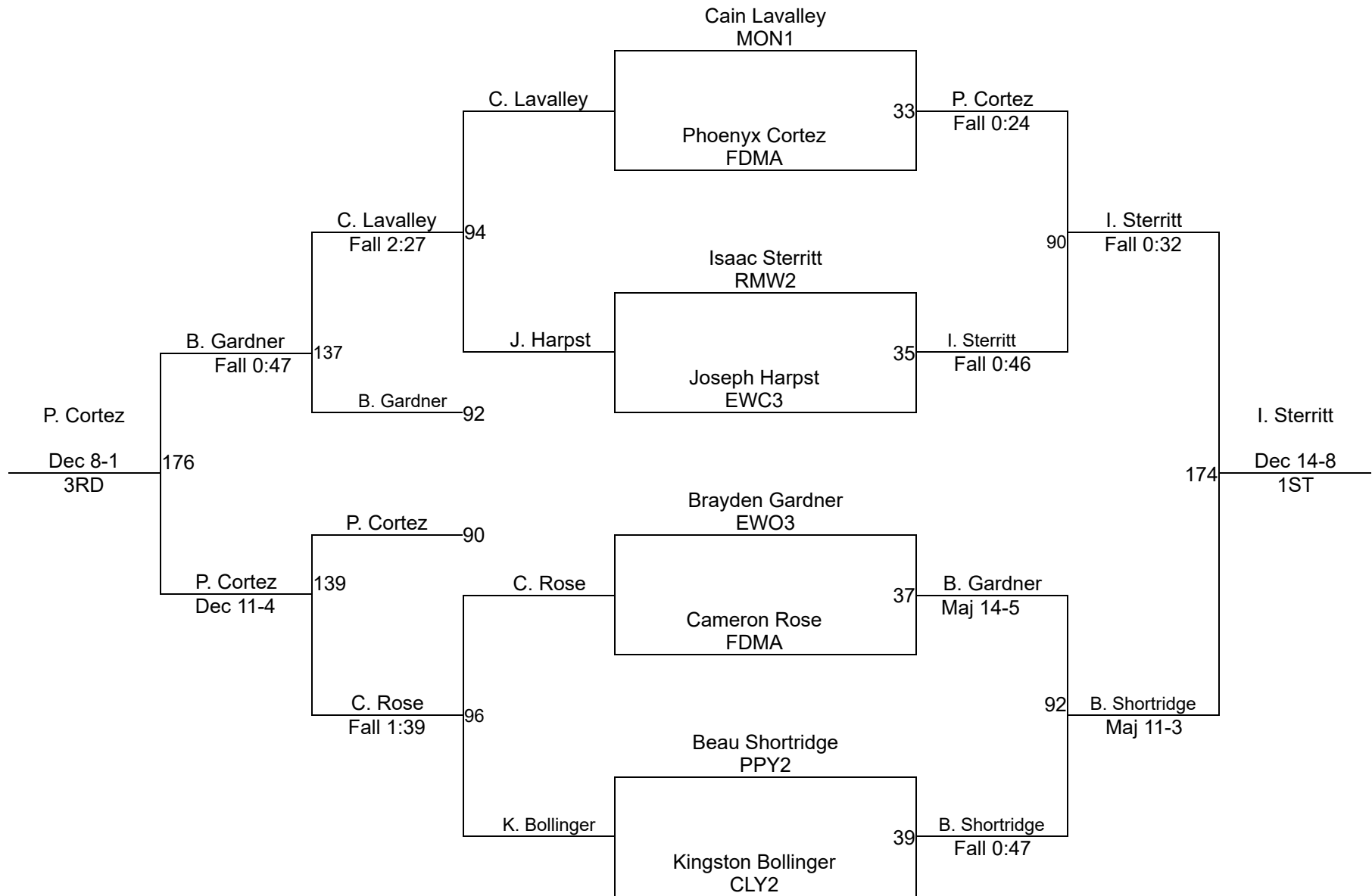

Perkins Pirates Open

Division IV Open 100-112

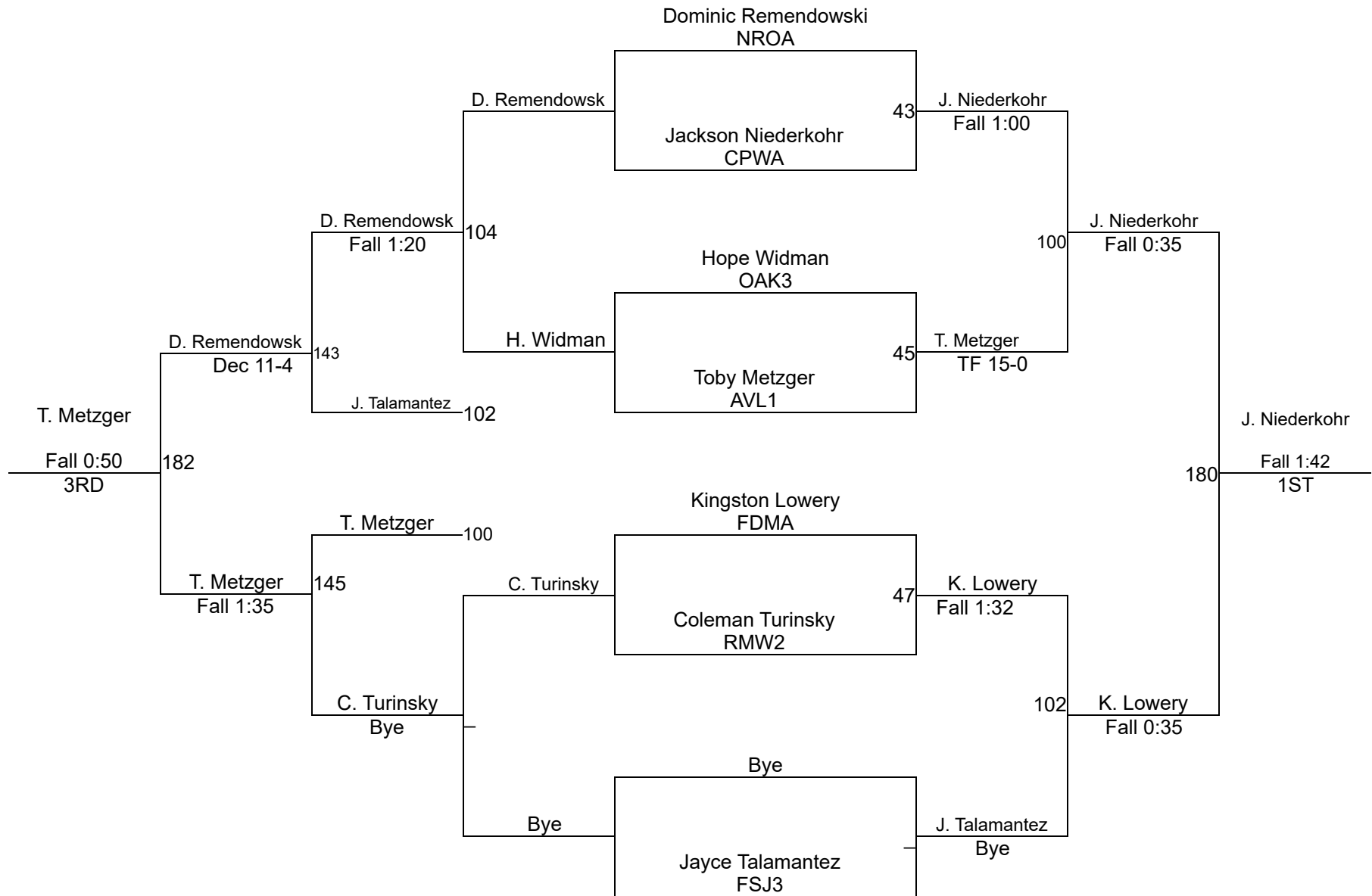

Perkins Pirates Open

Division IV Open 121-128

Round 1

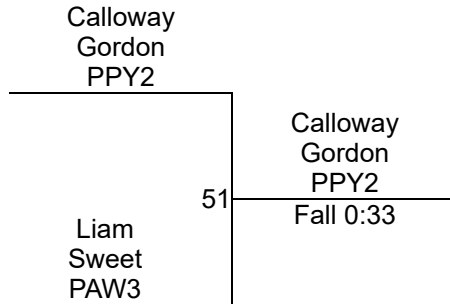

Round 2

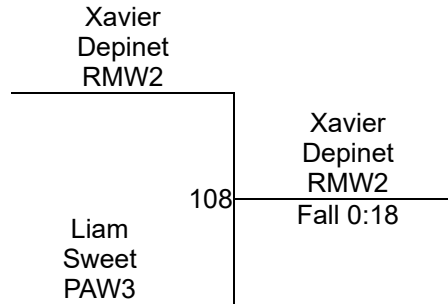

Round 3

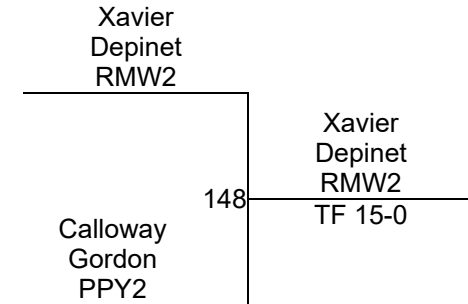

X. Depinet (RMW2)
1ST

C. Gordon (PPY2)
2ND

L. Sweet (PAW3)
3RD

Perkins Pirates Open

Division IV Open 139-159

Round 1

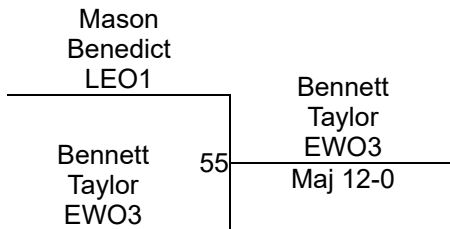
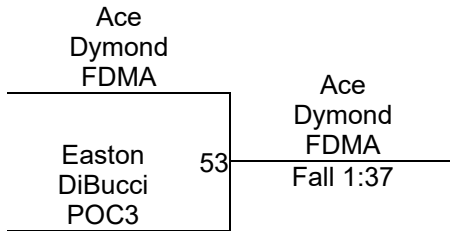

Round 2

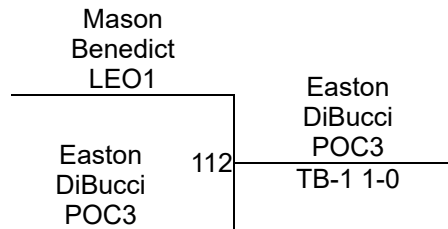
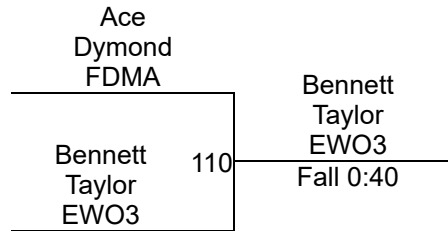

Round 3

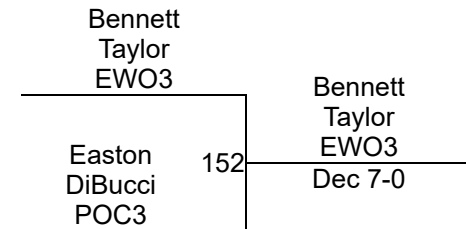
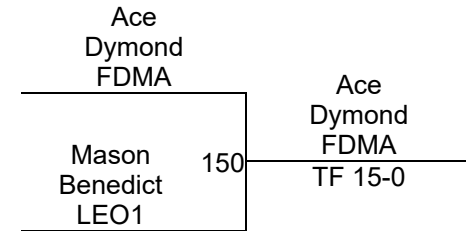

WRESTLERS

A. Dymond (FDMA)

E. DiBucci (POC3)

M. Benedict (LEO1)

B. Taylor (EWO3)

B. Taylor (EWO3)

1ST

A. Dymond (FDMA)

2ND

E. DiBucci (POC3)

3RD

M. Benedict (LEO1)

4TH