

2025 OAC Lakota West GS District

Division I 40

Round 1

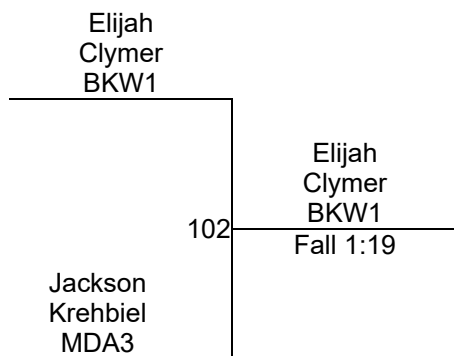

Round 2

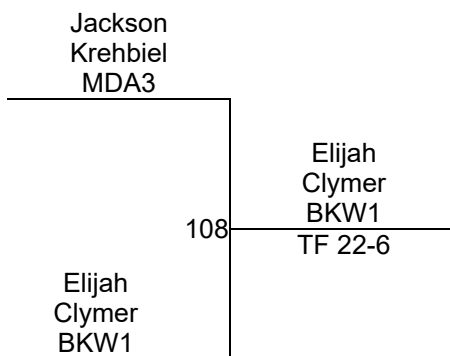

Round 3

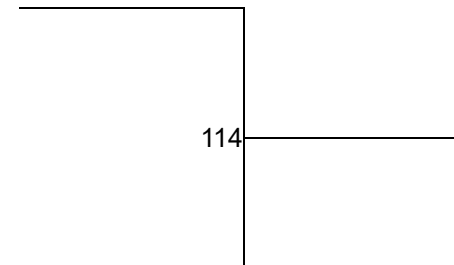

E. Clymer (BKW1)
1ST

J. Krehbiel (MDA3)
2ND

2025 OAC Lakota West GS District

Division I 45

Round 1

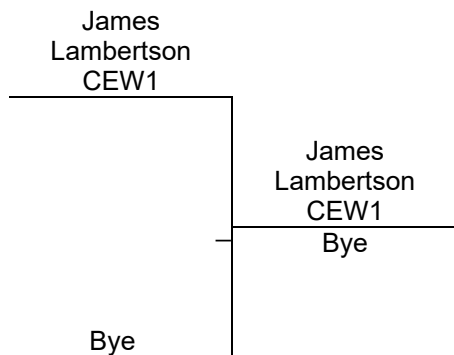

Round 2

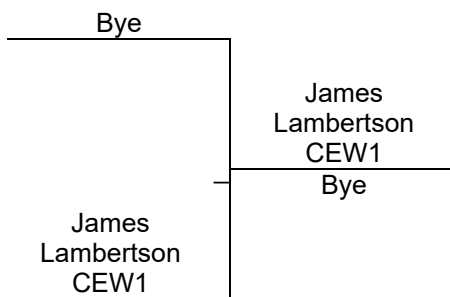

Round 3

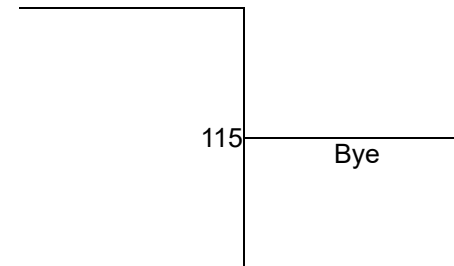

J. Lambertson (CEW1)
1ST

Bye
2ND

2025 OAC Lakota West GS District

Division I 50

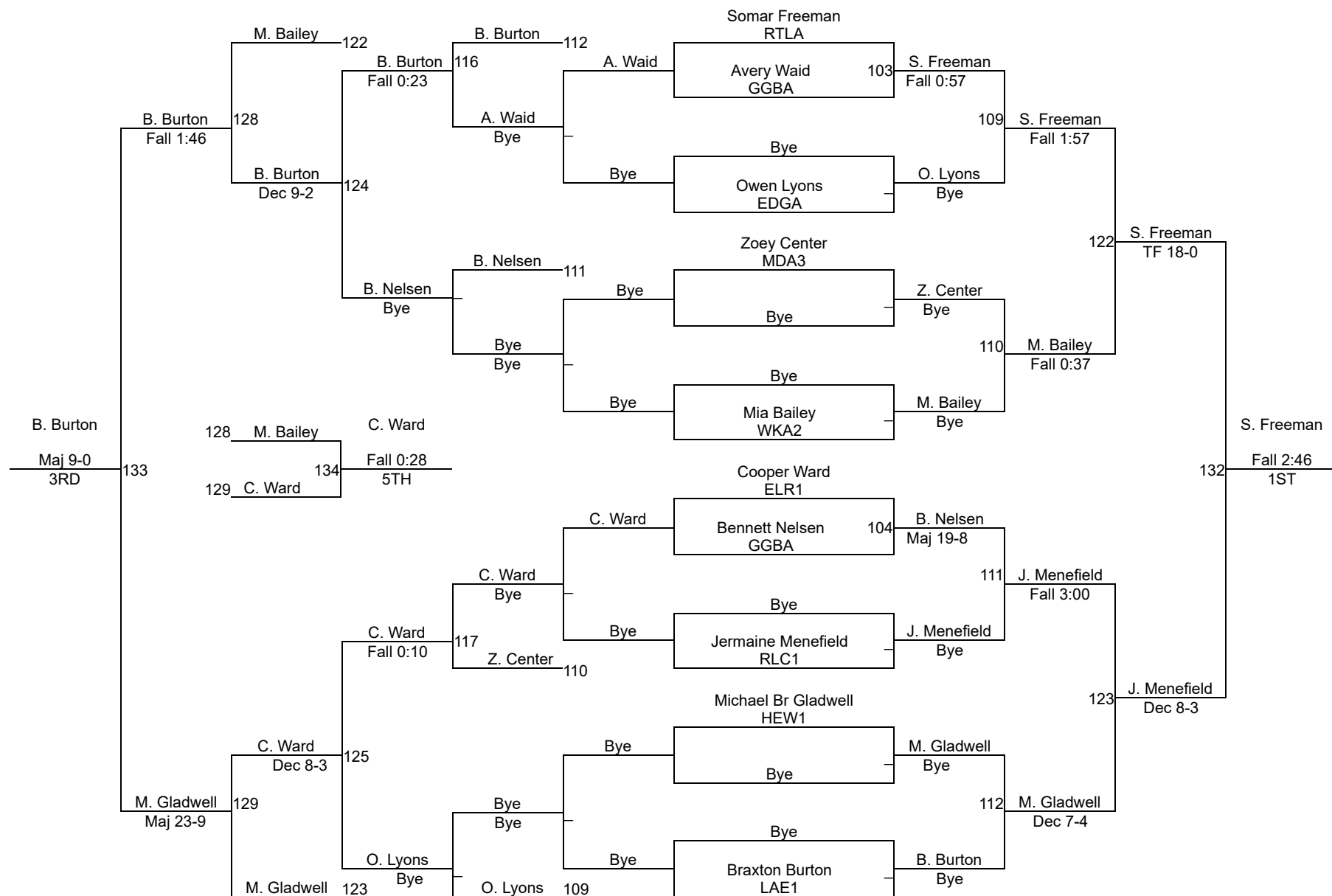

2025 OAC Lakota West GS District

Division I 55

Round 1

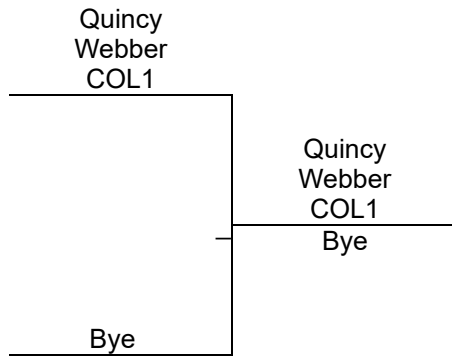

Round 2

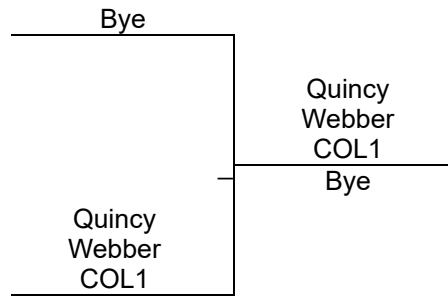

Round 3

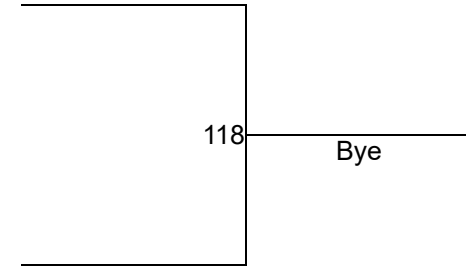

Q. Webber (COL1)

1ST

Bye

2ND

2025 OAC Lakota West GS District

Division I 60

Round 1

Solanus Toney SGB1		Solanus Toney SGB1	
Lincoln Harris RTLA	100	TF 15-0	

Weston Gragg		Asher Duer PRW1	
Asher Duer PRW1	101	TF 23-5	

H. Hampton (HAR1)
1ST

Round 2

Hudson Hampton HAR1		Hudson Hampton HAR1	
Asher Duer PRW1	106	Dec 7-0	

Solanus Toney SGB1		Solanus Toney SGB1	
Weston Gragg	107	Fall 2:39	

A. Duer (PRW1)
2ND

Round 3

Hudson Hampton HAR1		Hudson Hampton HAR1	
Weston Gragg	119	Fall 1:17	

Lincoln Harris RTLA		Asher Duer PRW1	
Asher Duer PRW1	120	Fall 3:00	

S. Toney (SGB1)
3RD

Round 4

Hudson Hampton HAR1		Hudson Hampton HAR1	
Lincoln Harris RTLA	126	TF 16-0	

Solanus Toney SGB1		Asher Duer PRW1	
Asher Duer PRW1	127	Fall 4:22	

L. Harris (RTLA)
4TH

Round 5

Hudson Hampton HAR1		Hudson Hampton HAR1	
Solanus Toney SGB1	130	TF 23-4	

Lincoln Harris RTLA		Lincoln Harris RTLA	
Weston Gragg	131	Fall 1:25	

W. Gragg ()
5TH

2025 OAC Lakota West GS District

Division I 75

Round 1

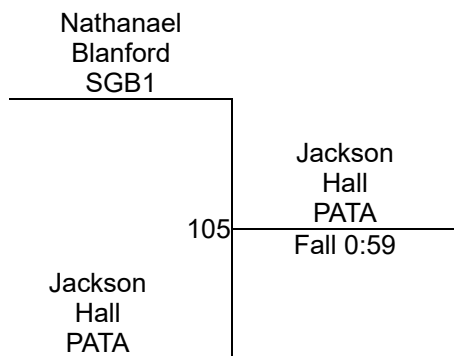

Round 2

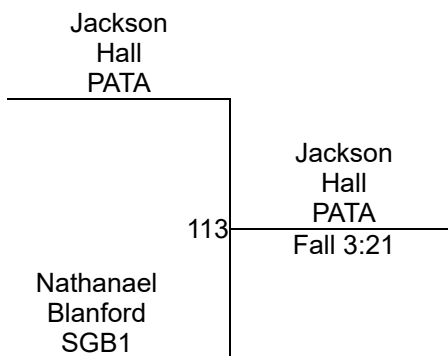

Round 3

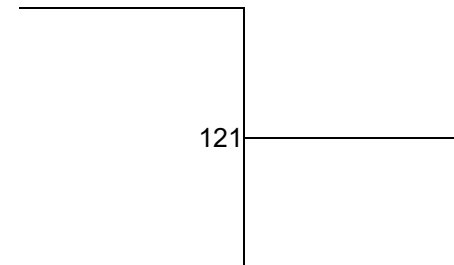

J. Hall (PATA)
1ST

N. Blanford (SGB1)
2ND

2025 OAC Lakota West GS District

Division II 45

Round 1

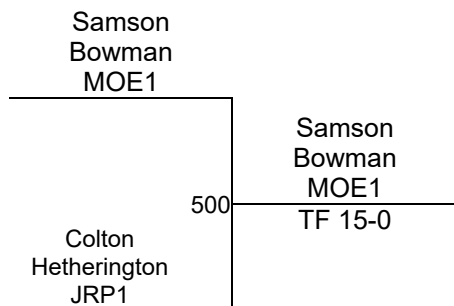

Round 2

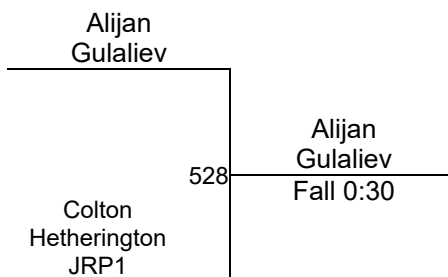

Round 3

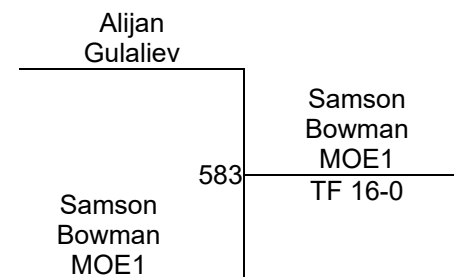

 S. Bowman (MOE1)
1ST

 A. Gulaliev ()
2ND

 C. Hetherington (JRP1)
3RD

2025 OAC Lakota West GS District

Division II 50

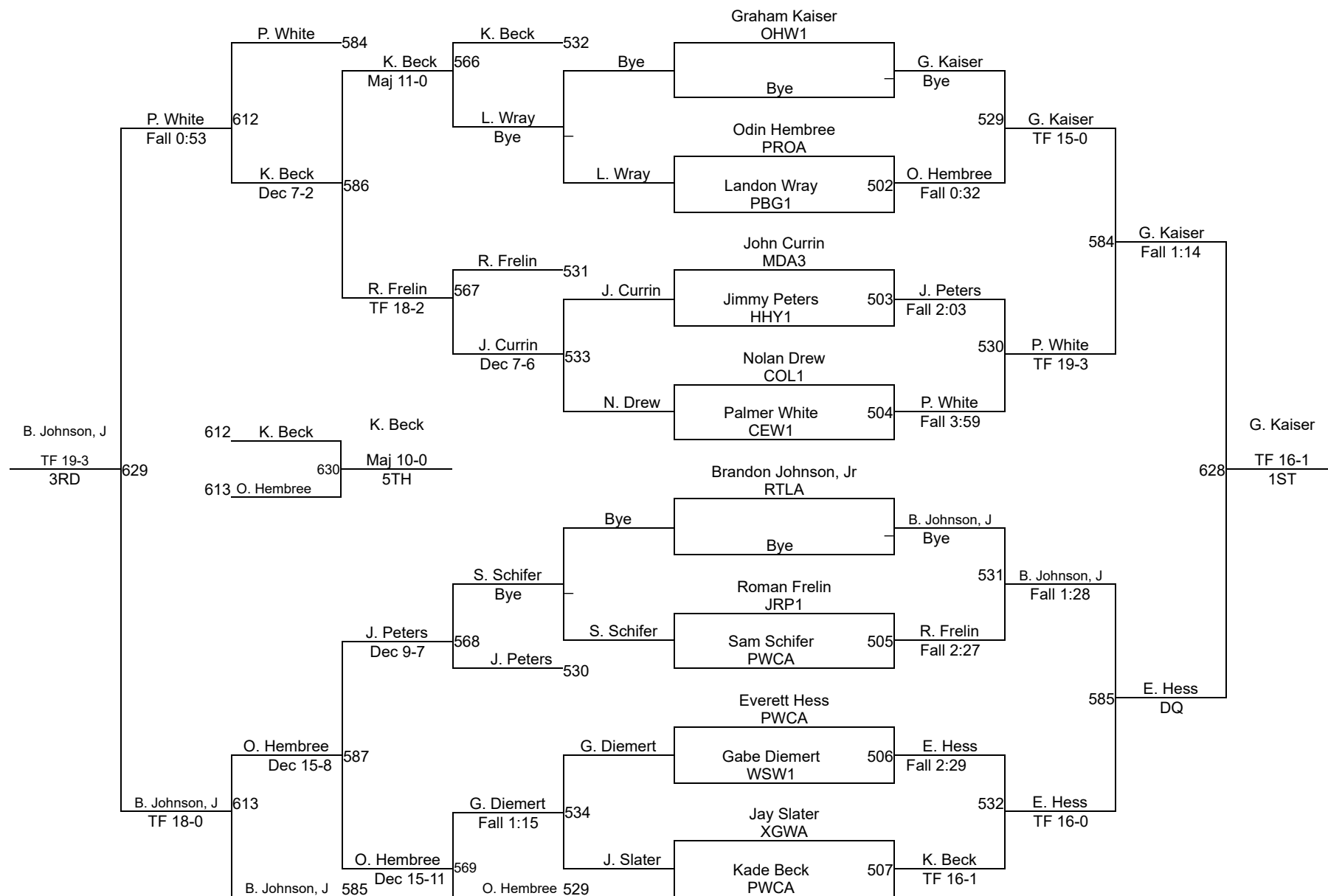

2025 OAC Lakota West GS District

Division II 55

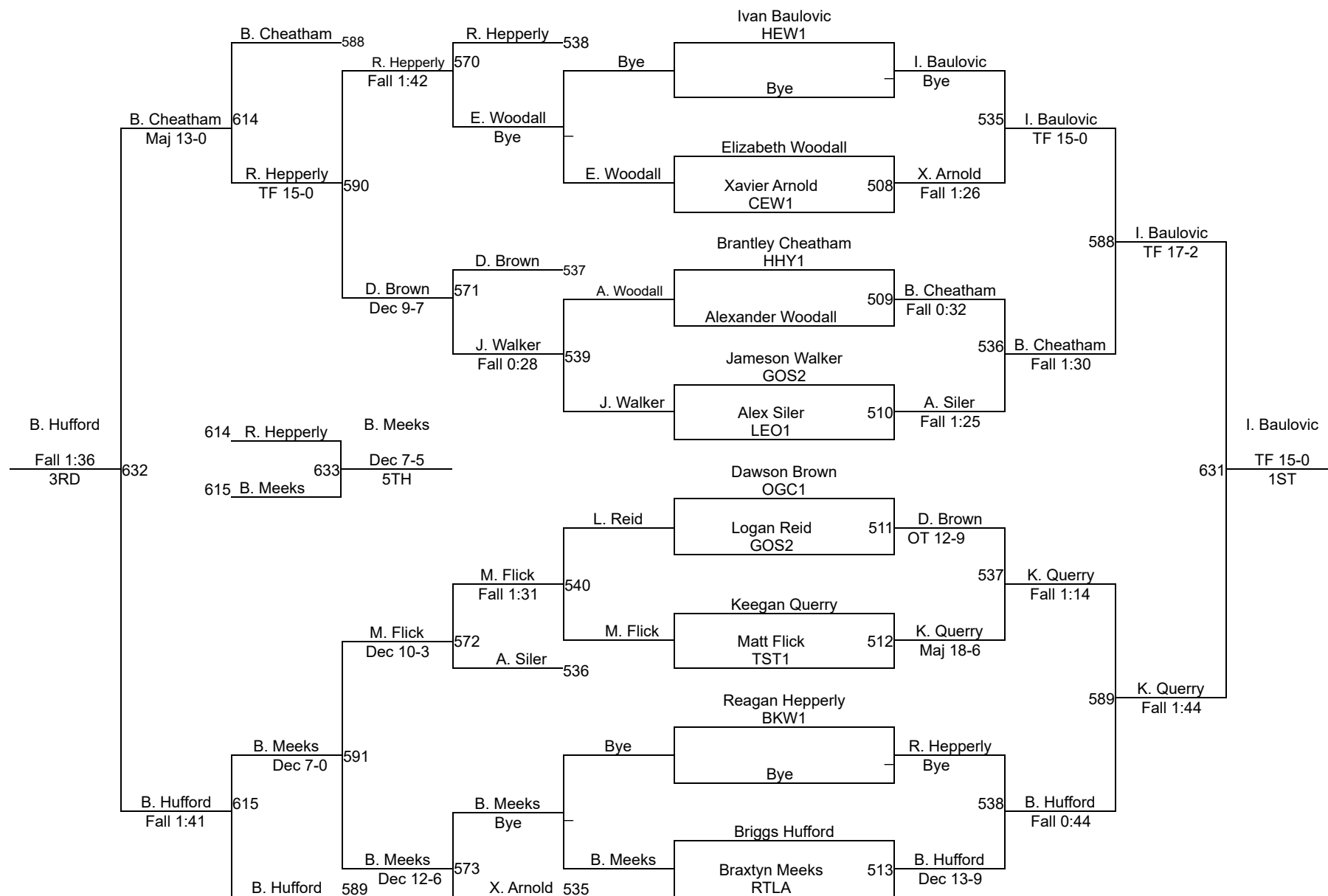

2025 OAC Lakota West GS District

Division II 58

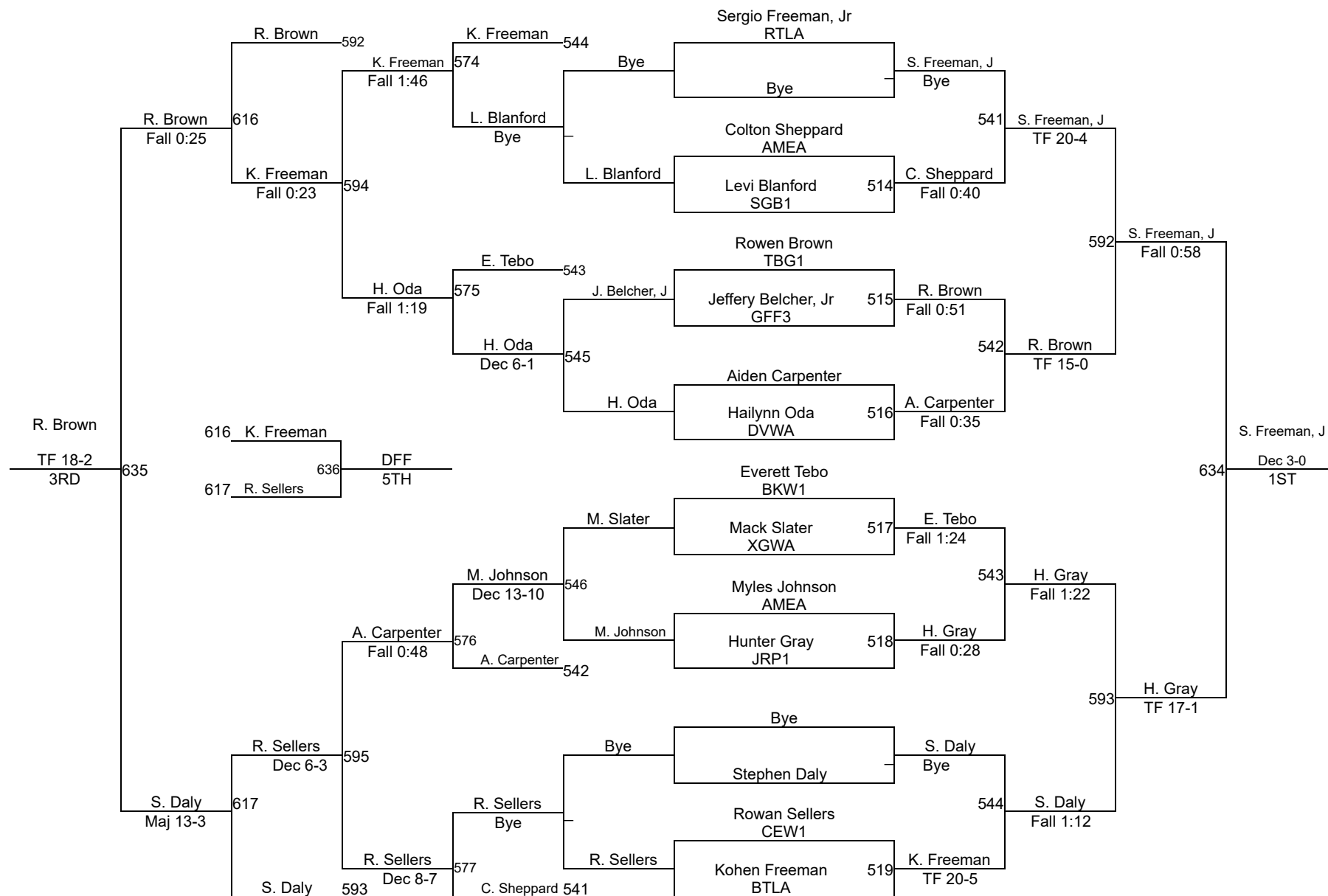

2025 OAC Lakota West GS District

Division II 61

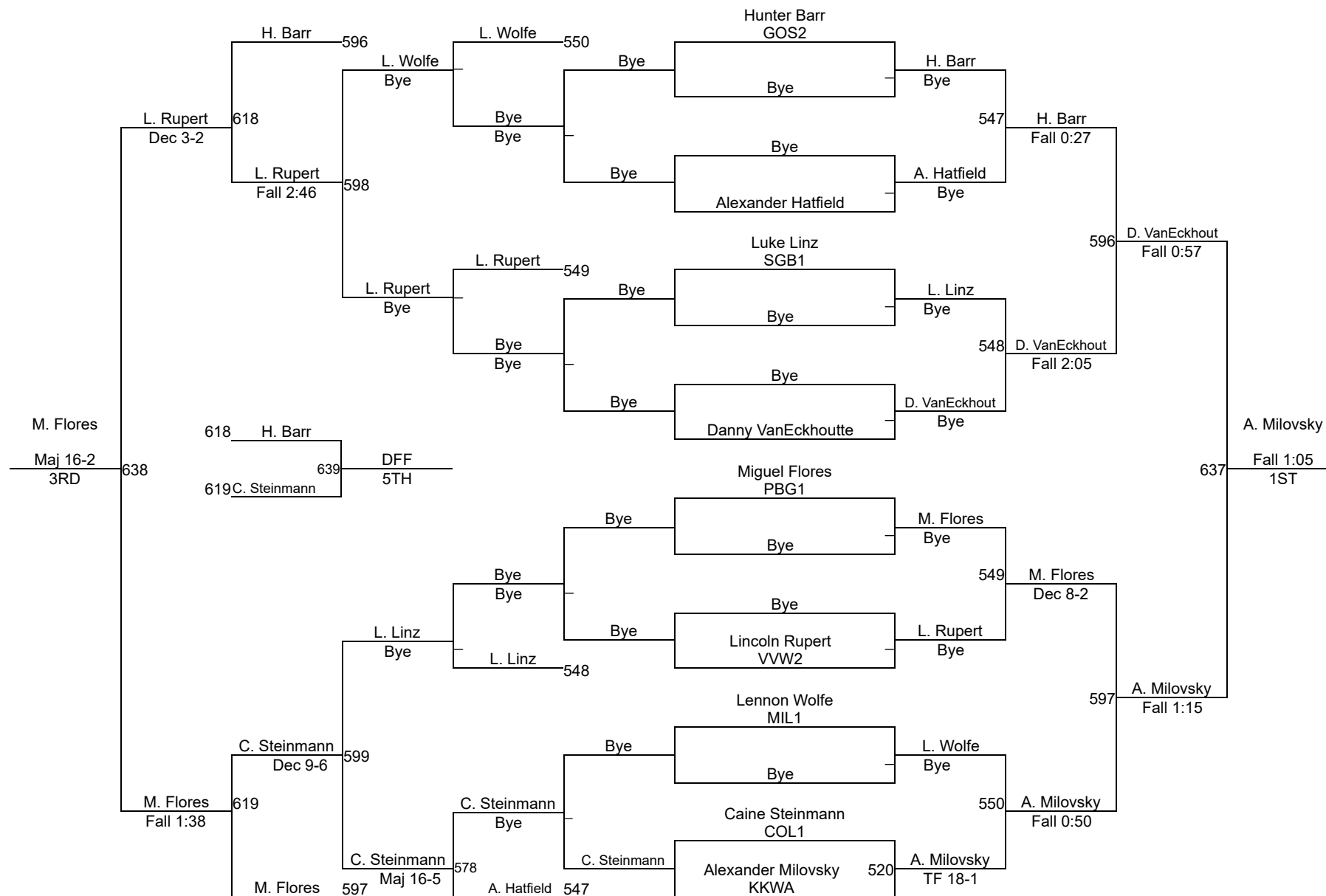

2025 OAC Lakota West GS District

Division II 65

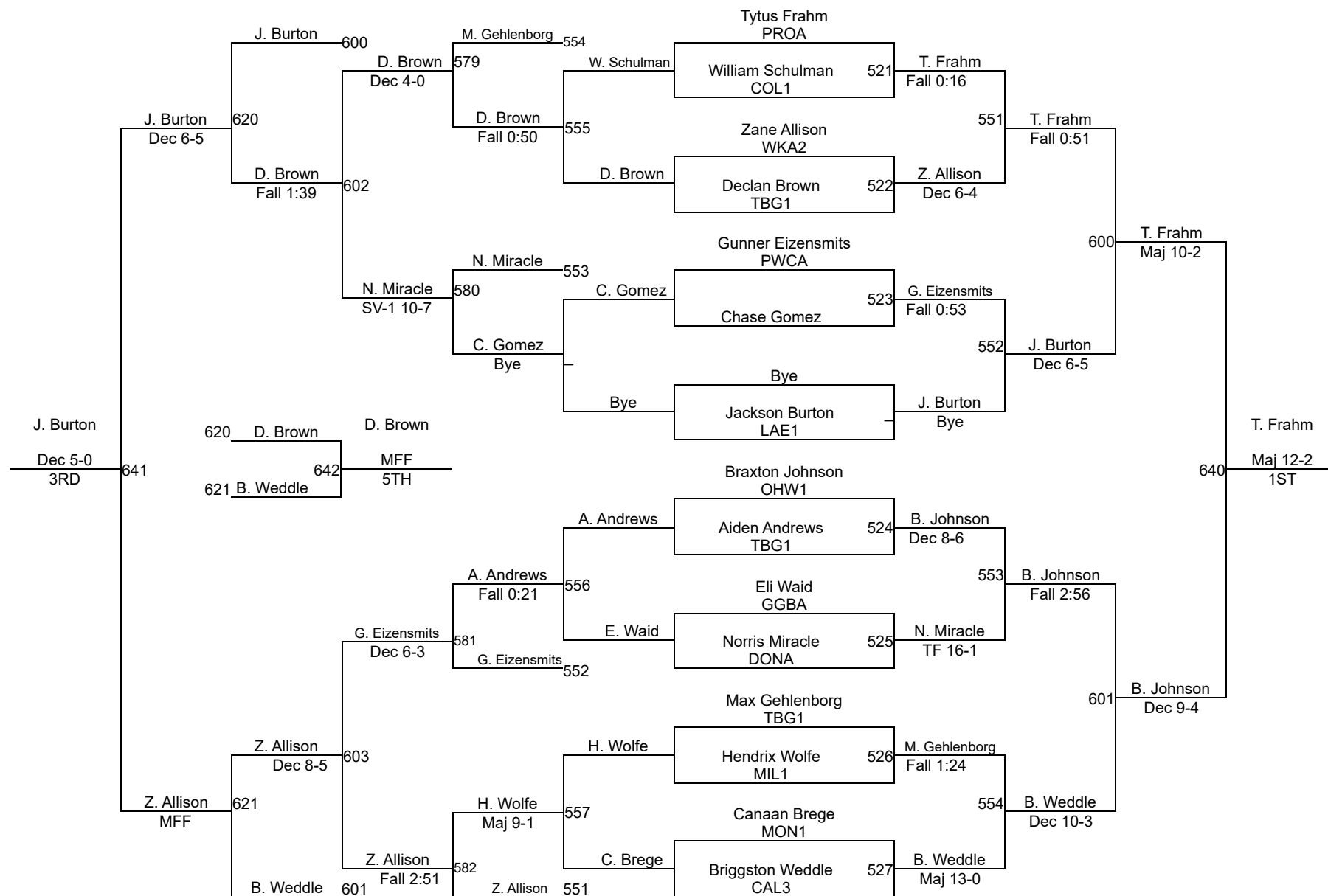

2025 OAC Lakota West GS District

Division II 70

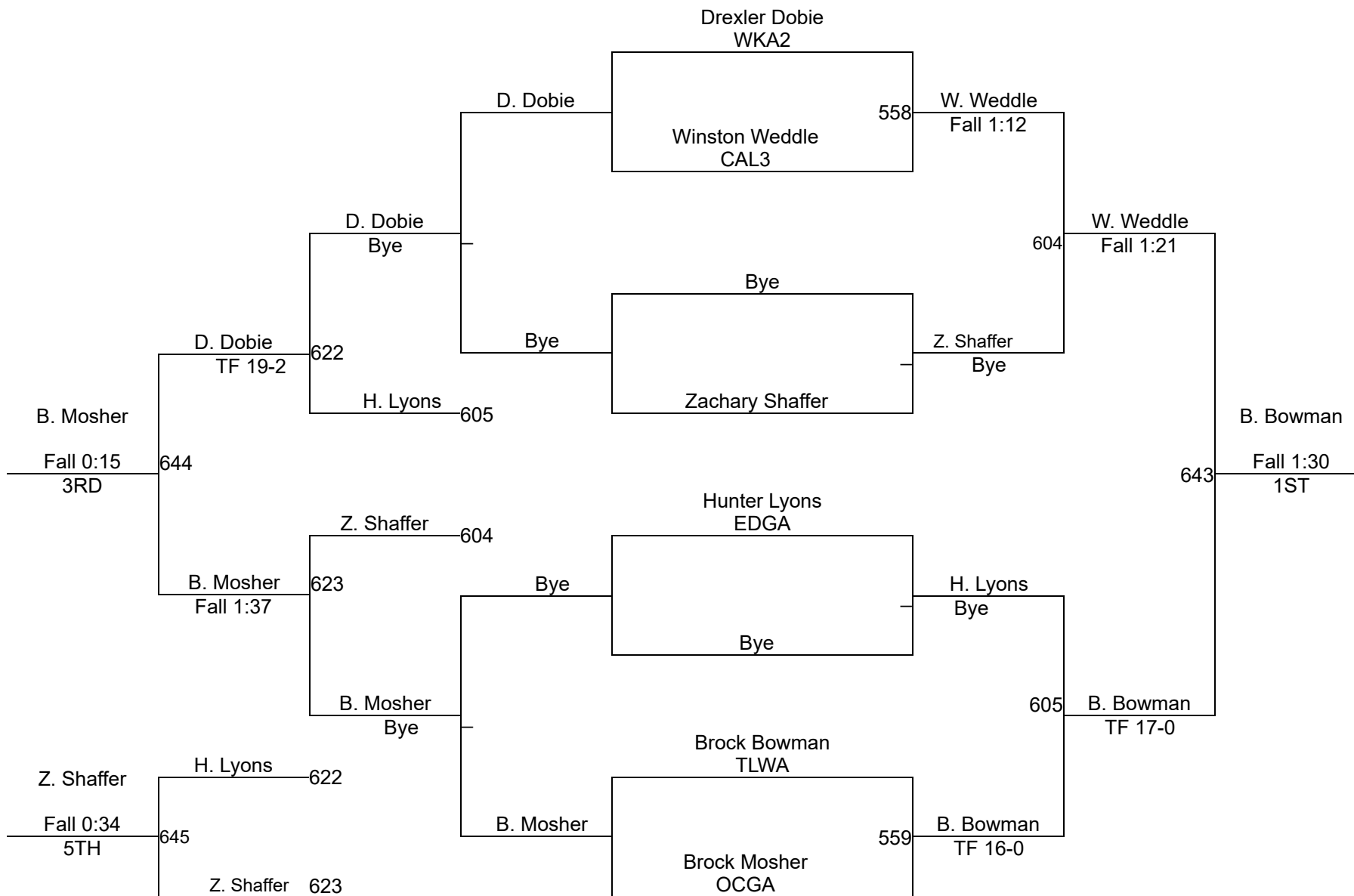

2025 OAC Lakota West GS District

Division II 75

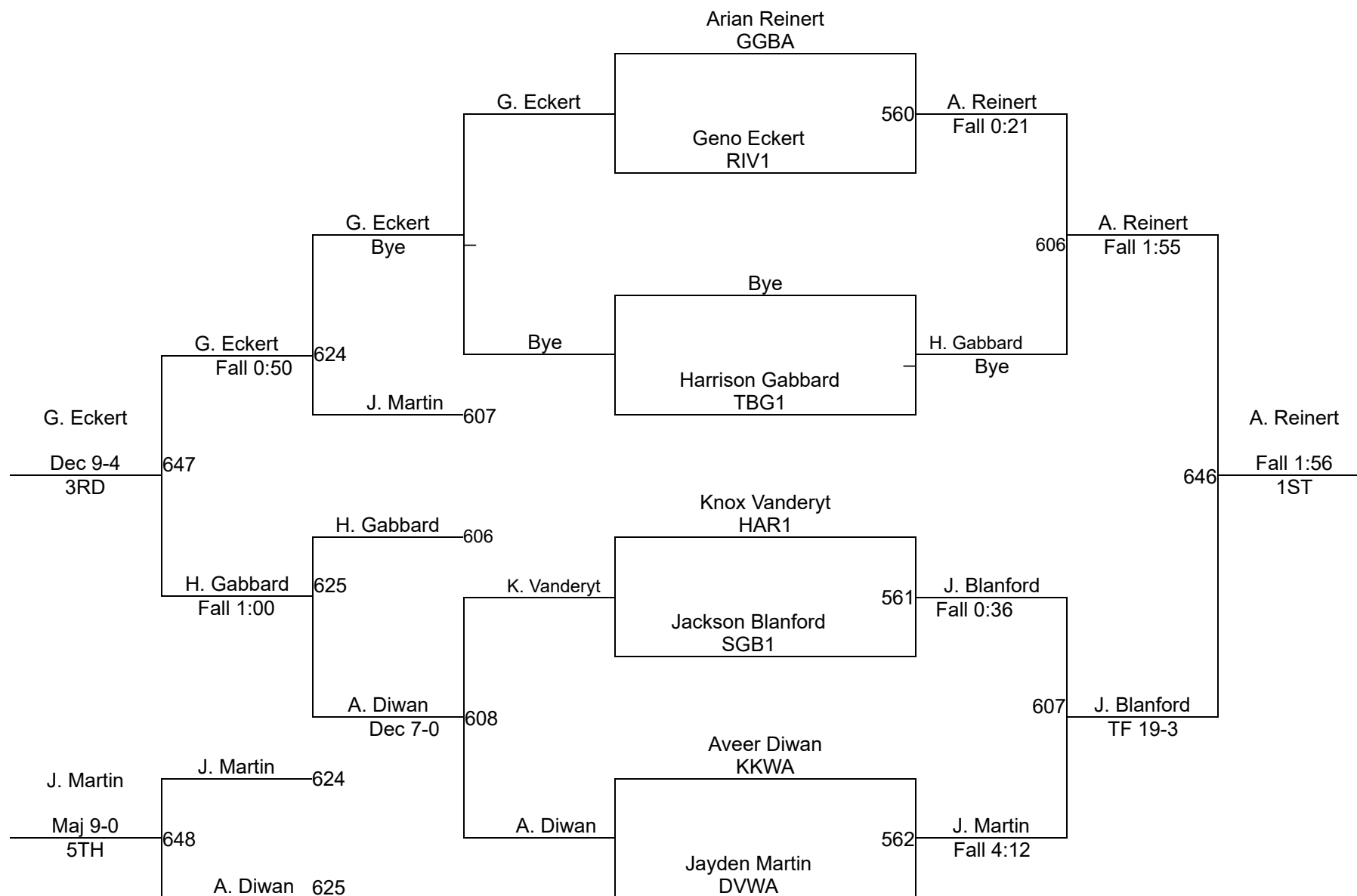

2025 OAC Lakota West GS District

Division II 85

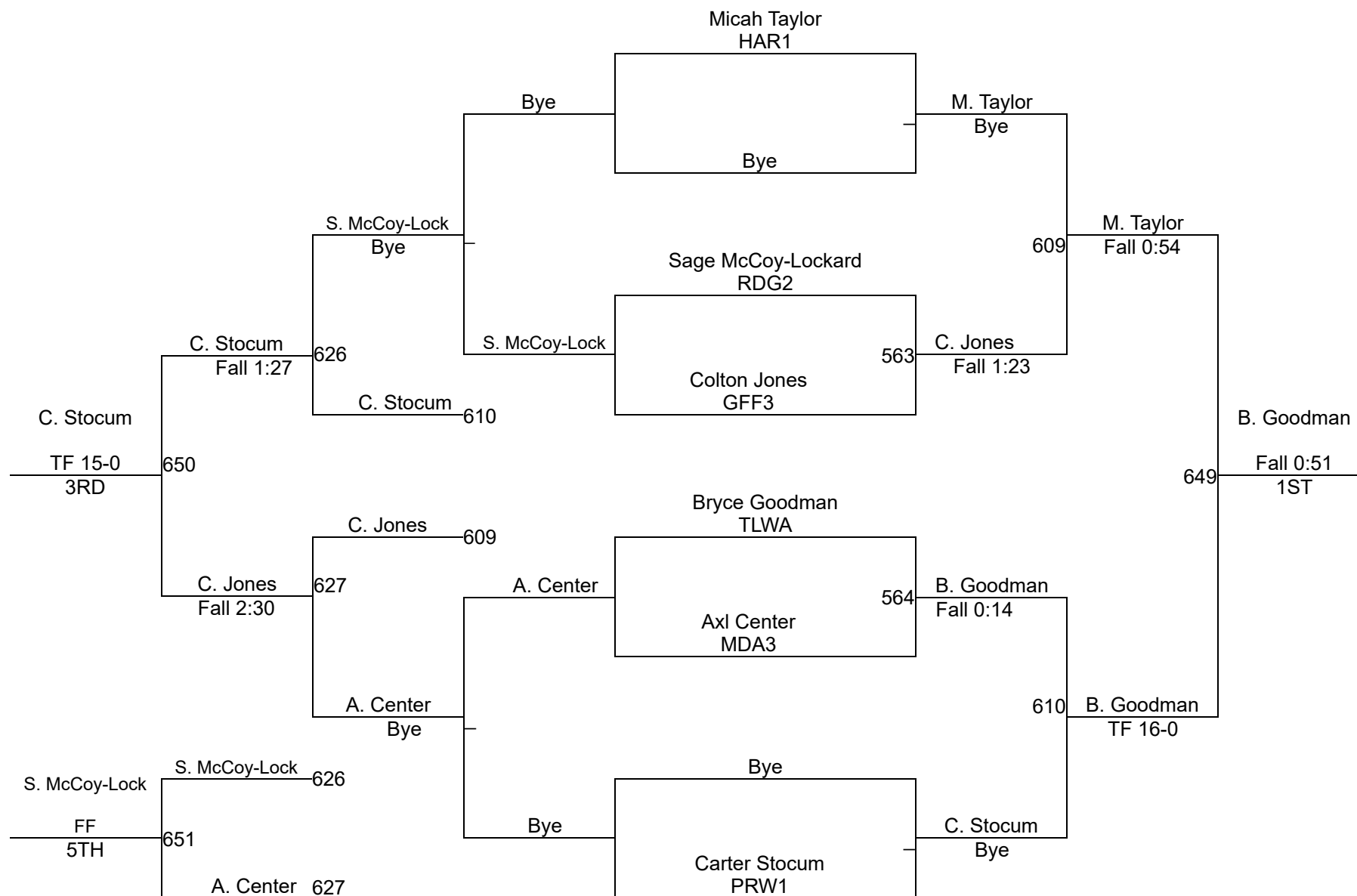

2025 OAC Lakota West GS District

Division II 120

Round 1

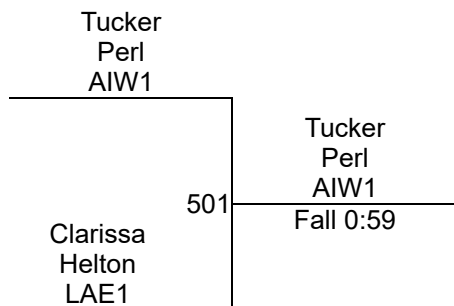

Round 2

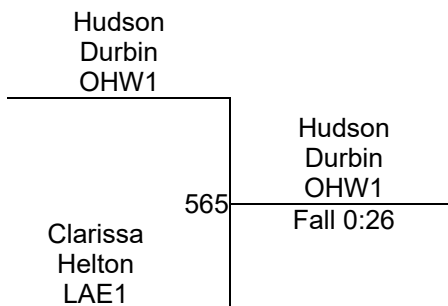

Round 3

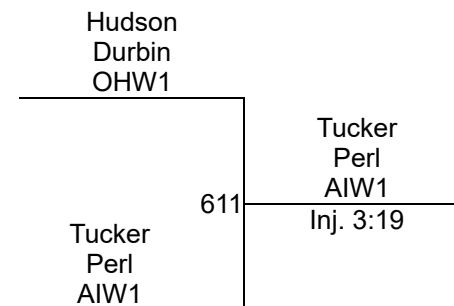

T. Perl (AIW1)
1ST

H. Durbin (OHW1)
2ND

C. Helton (LAE1)
3RD

2025 OAC Lakota West GS District

Division III 55

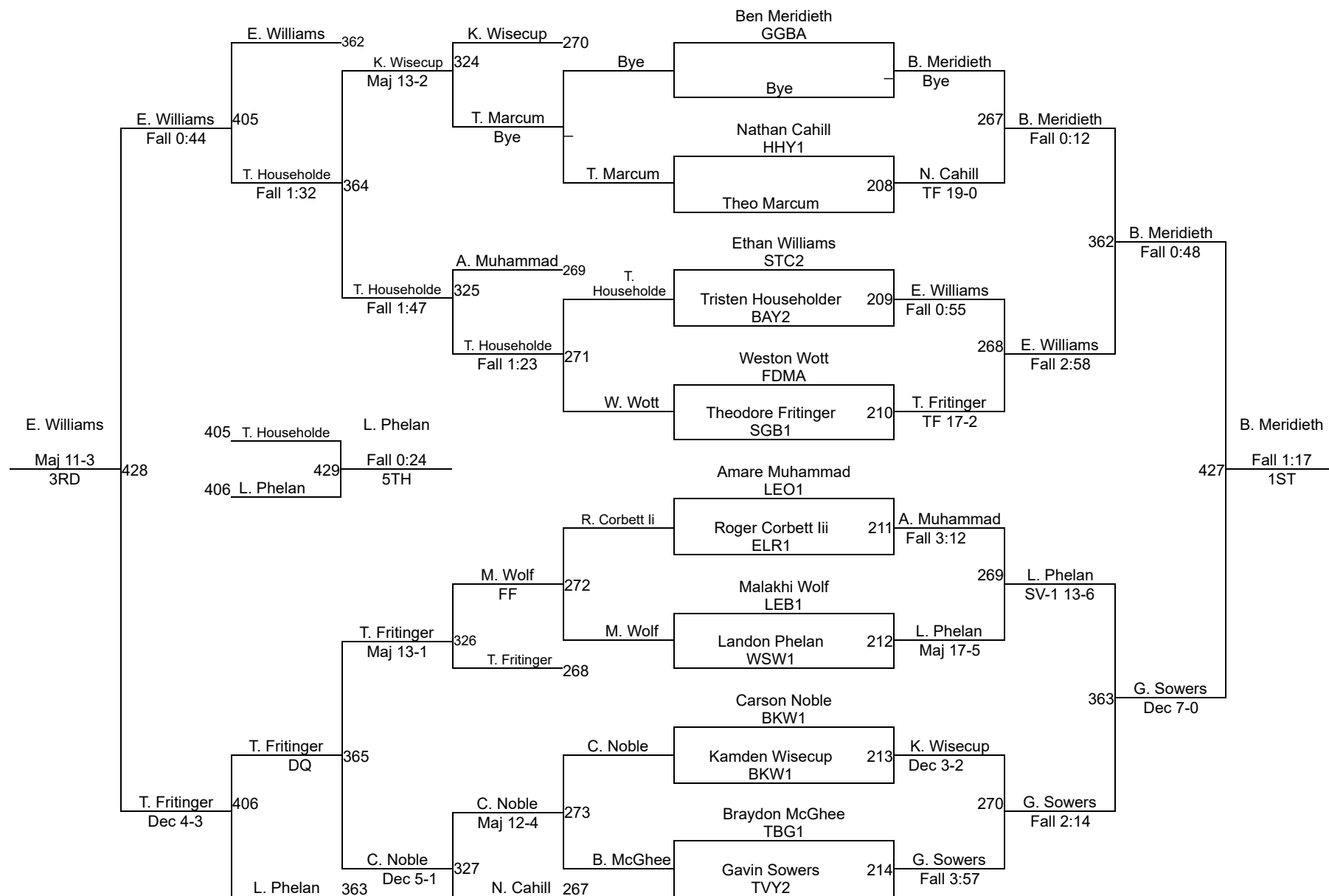

2025 OAC Lakota West GS District

Division III 60

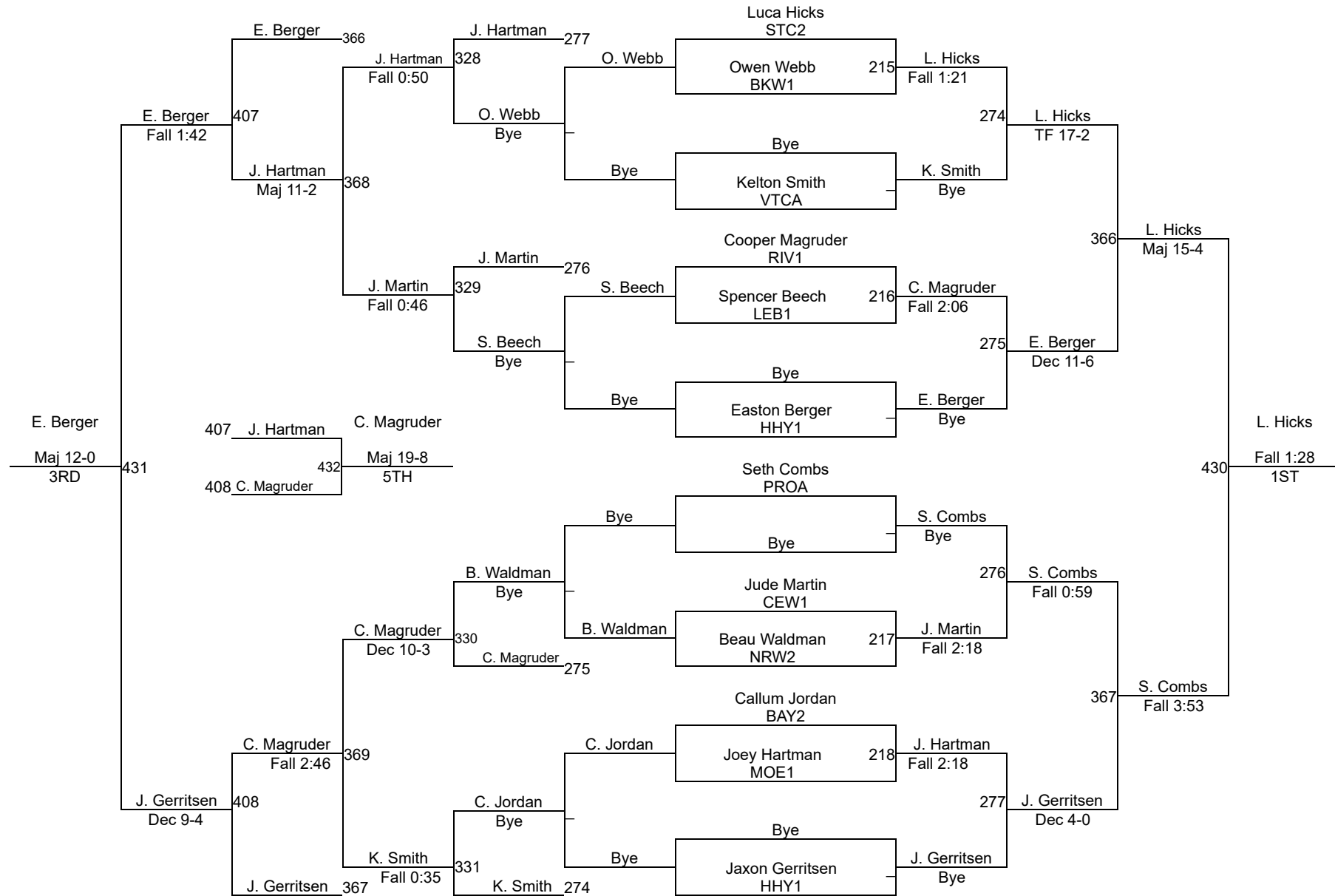

2025 OAC Lakota West GS District

Division III 65

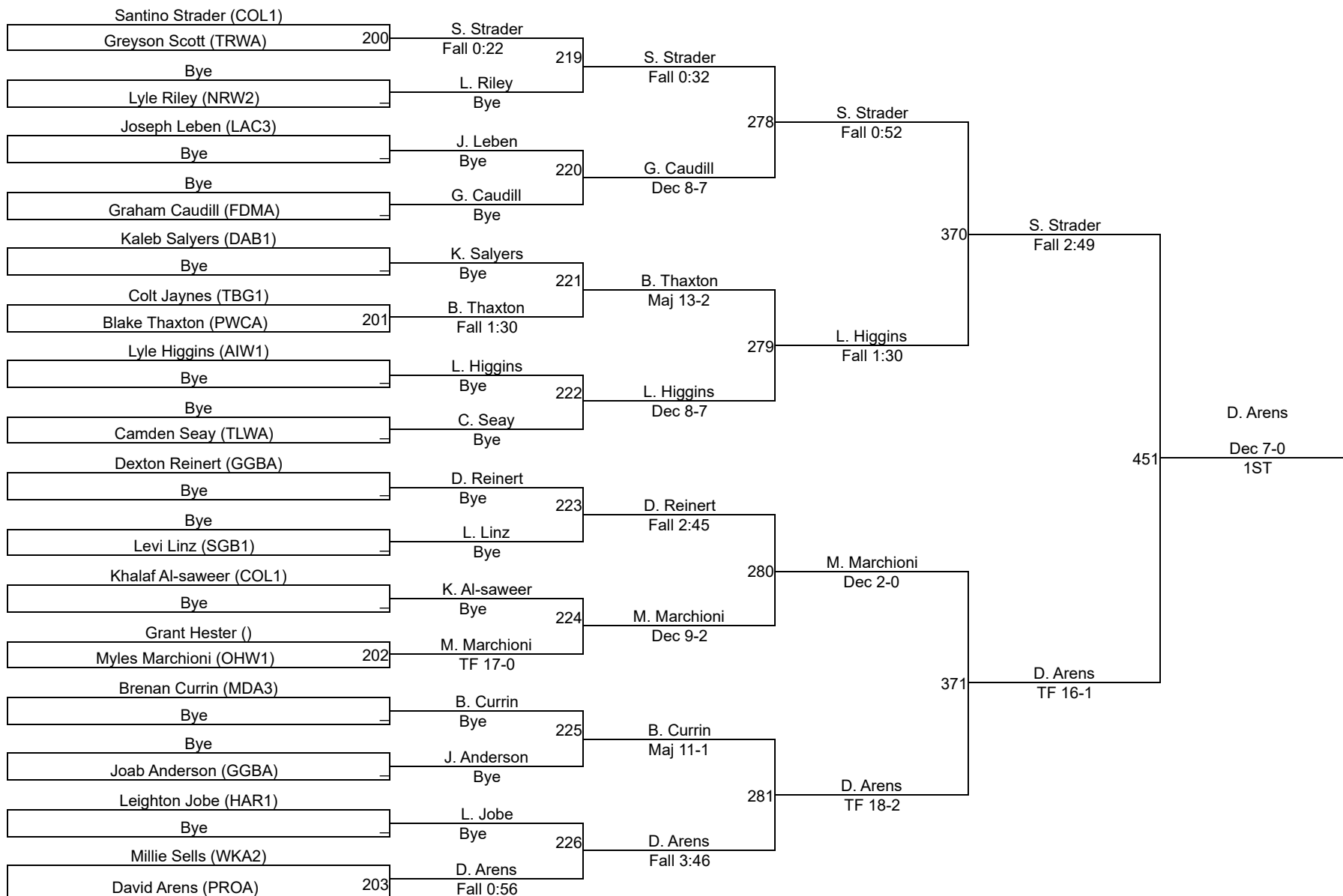

Division III 65

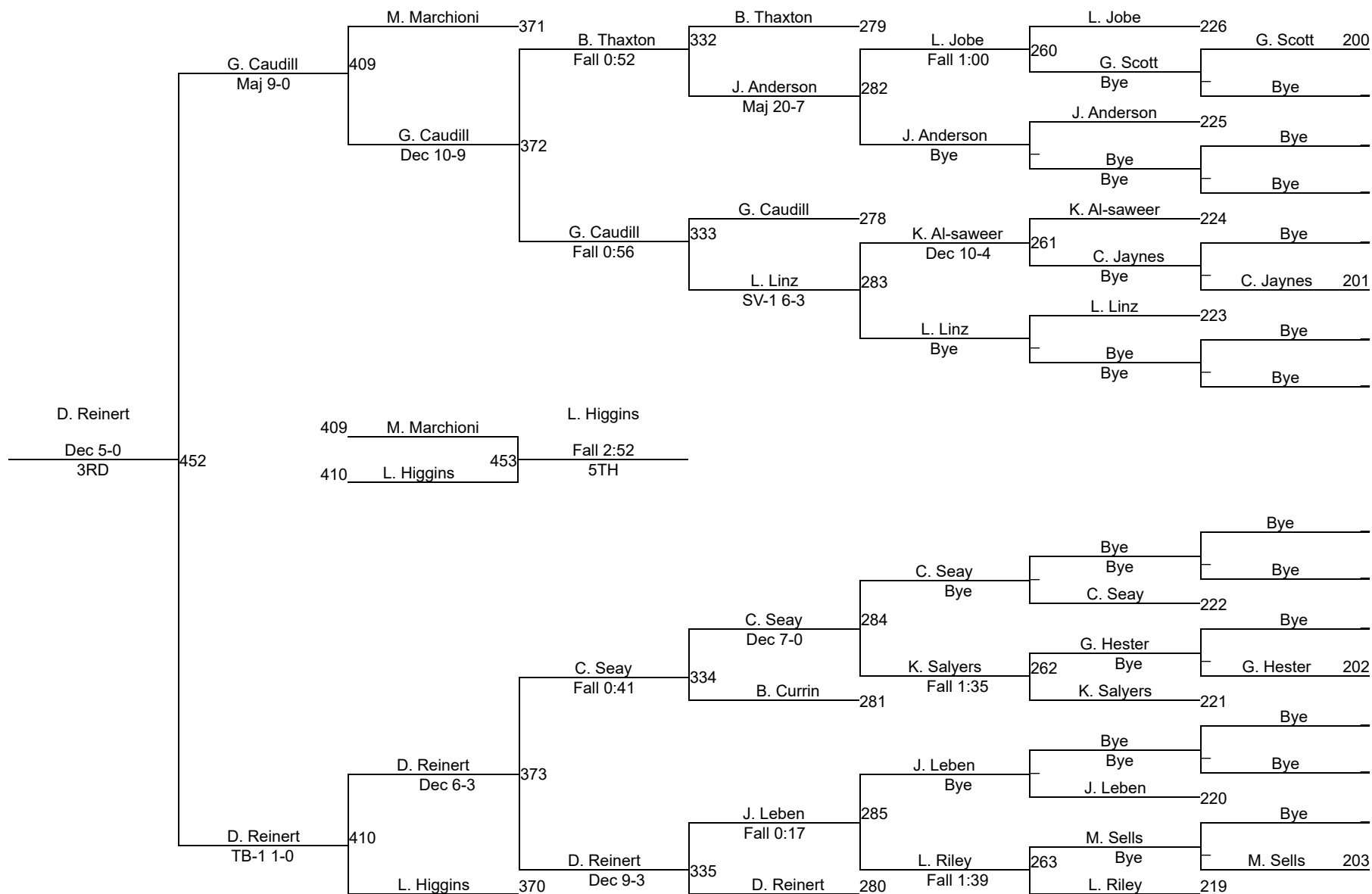

2025 OAC Lakota West GS District

Division III 68

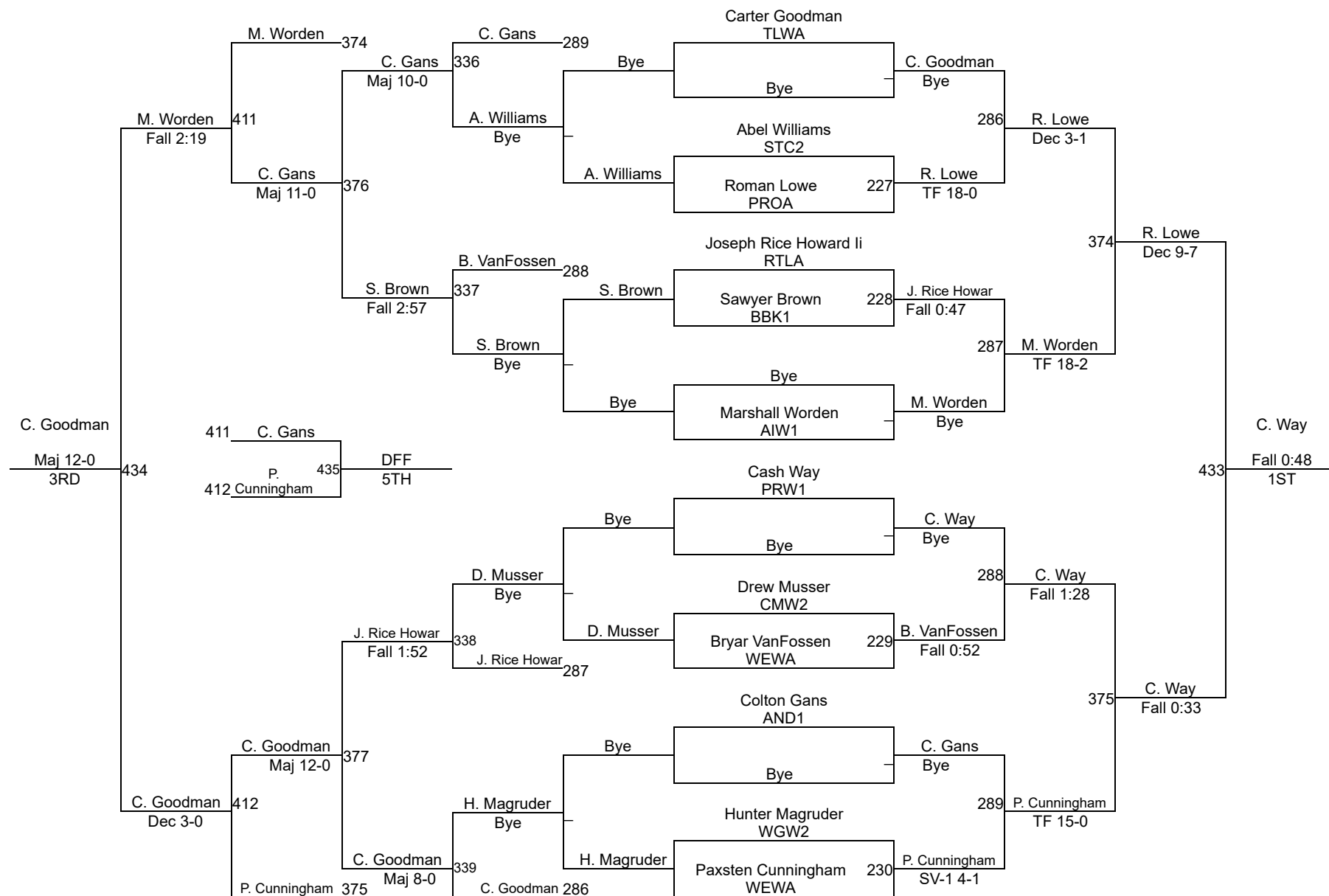

2025 OAC Lakota West GS District

Division III 71

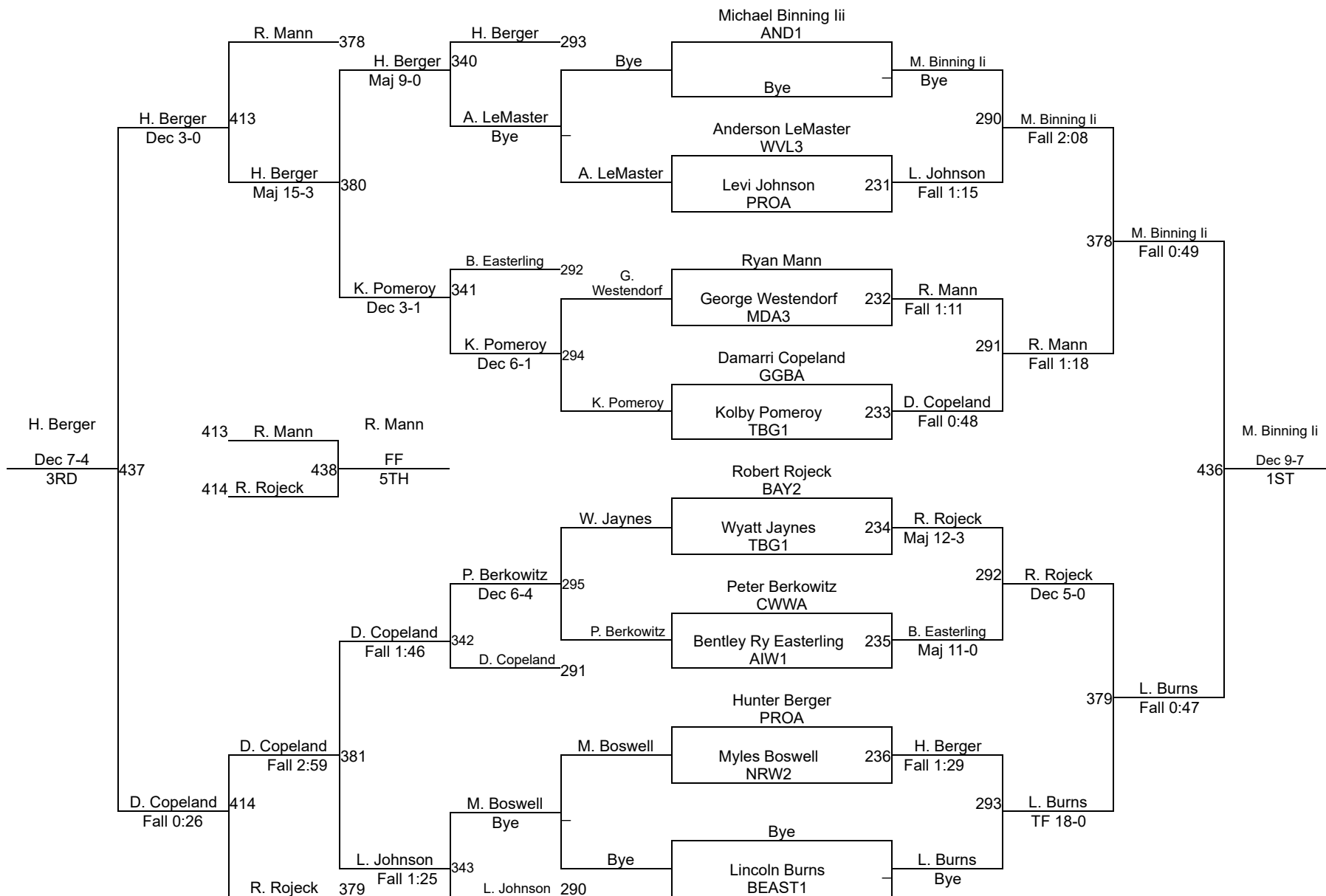

2025 OAC Lakota West GS District

Division III 75

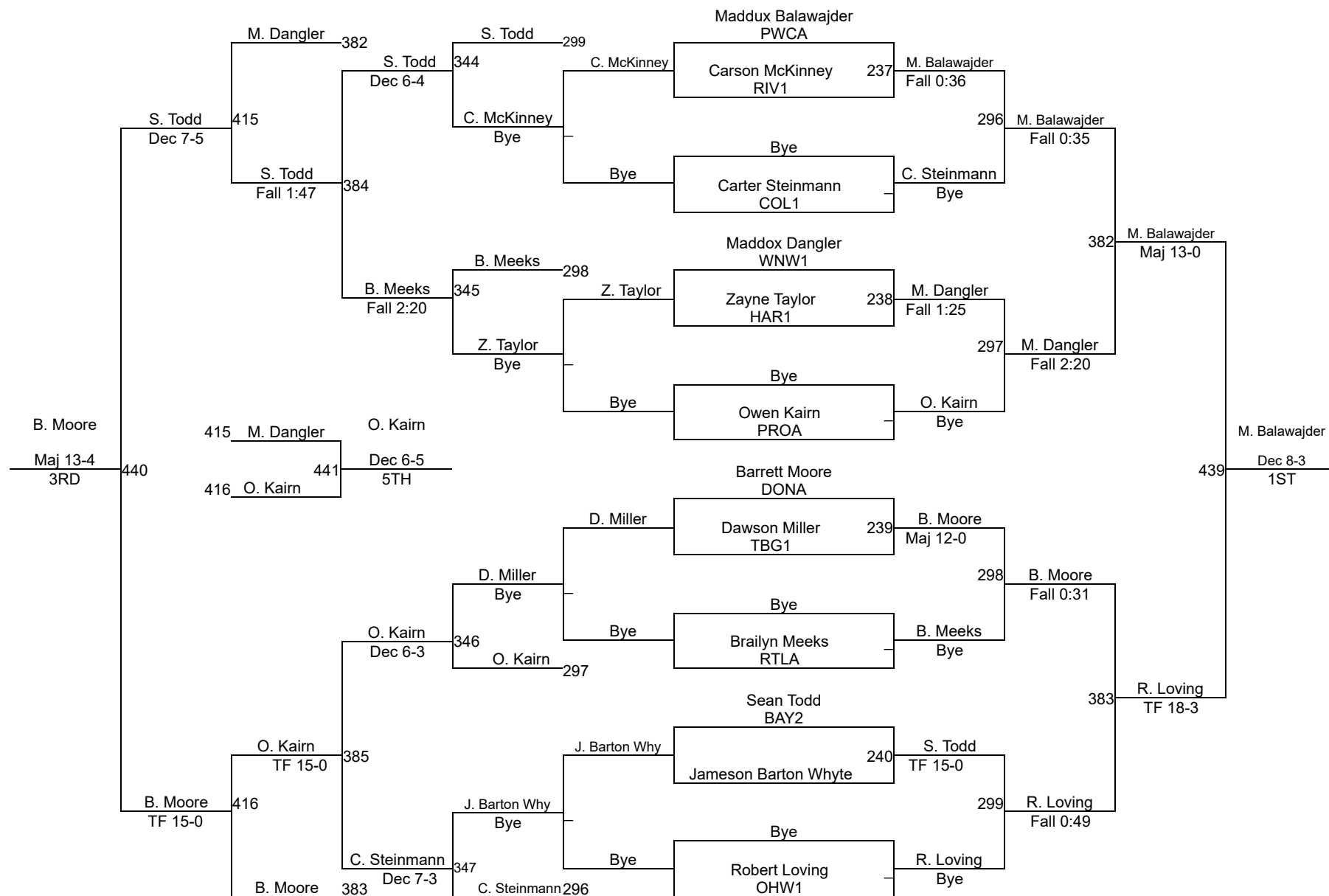

2025 OAC Lakota West GS District

Division III 80

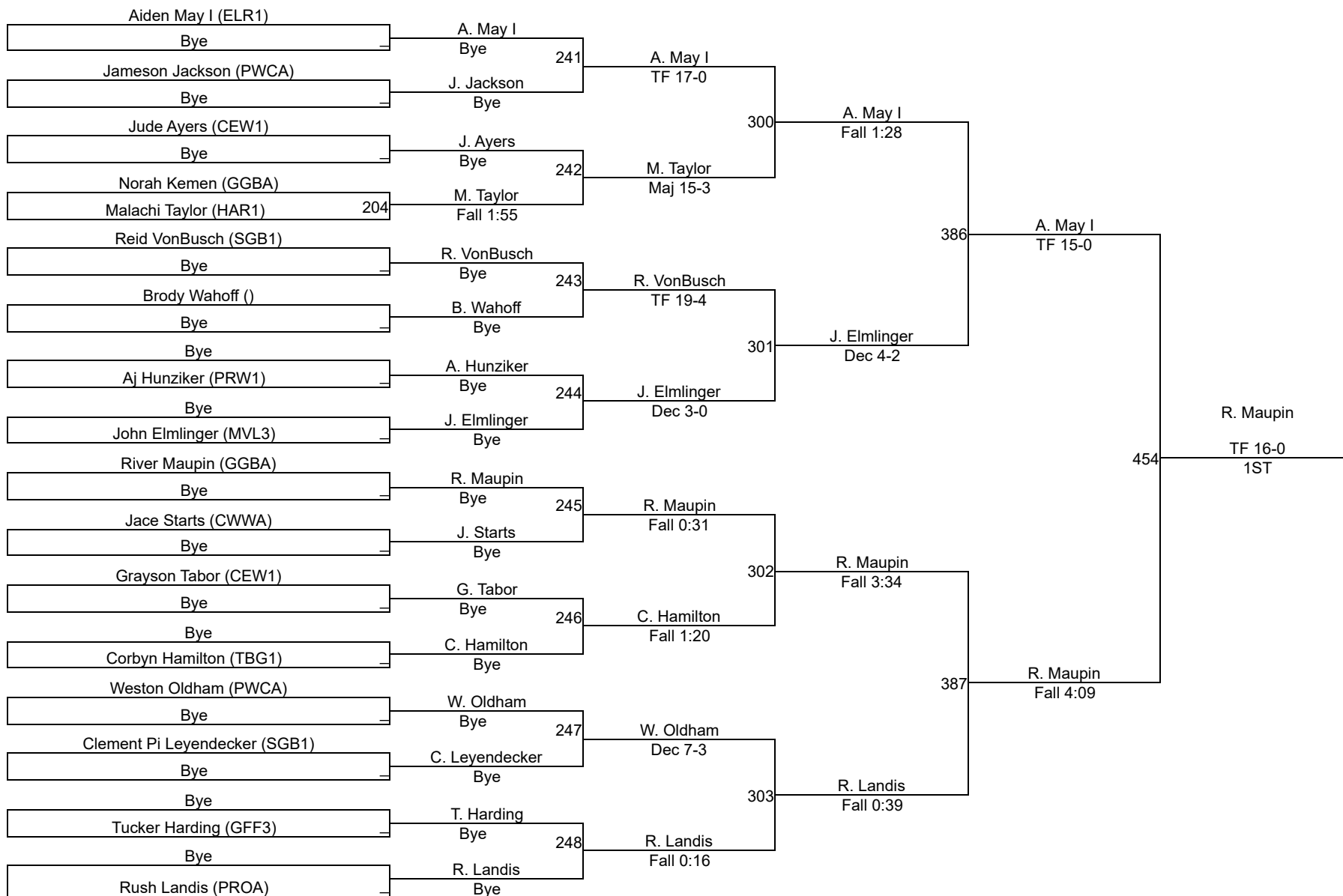

Division III 80

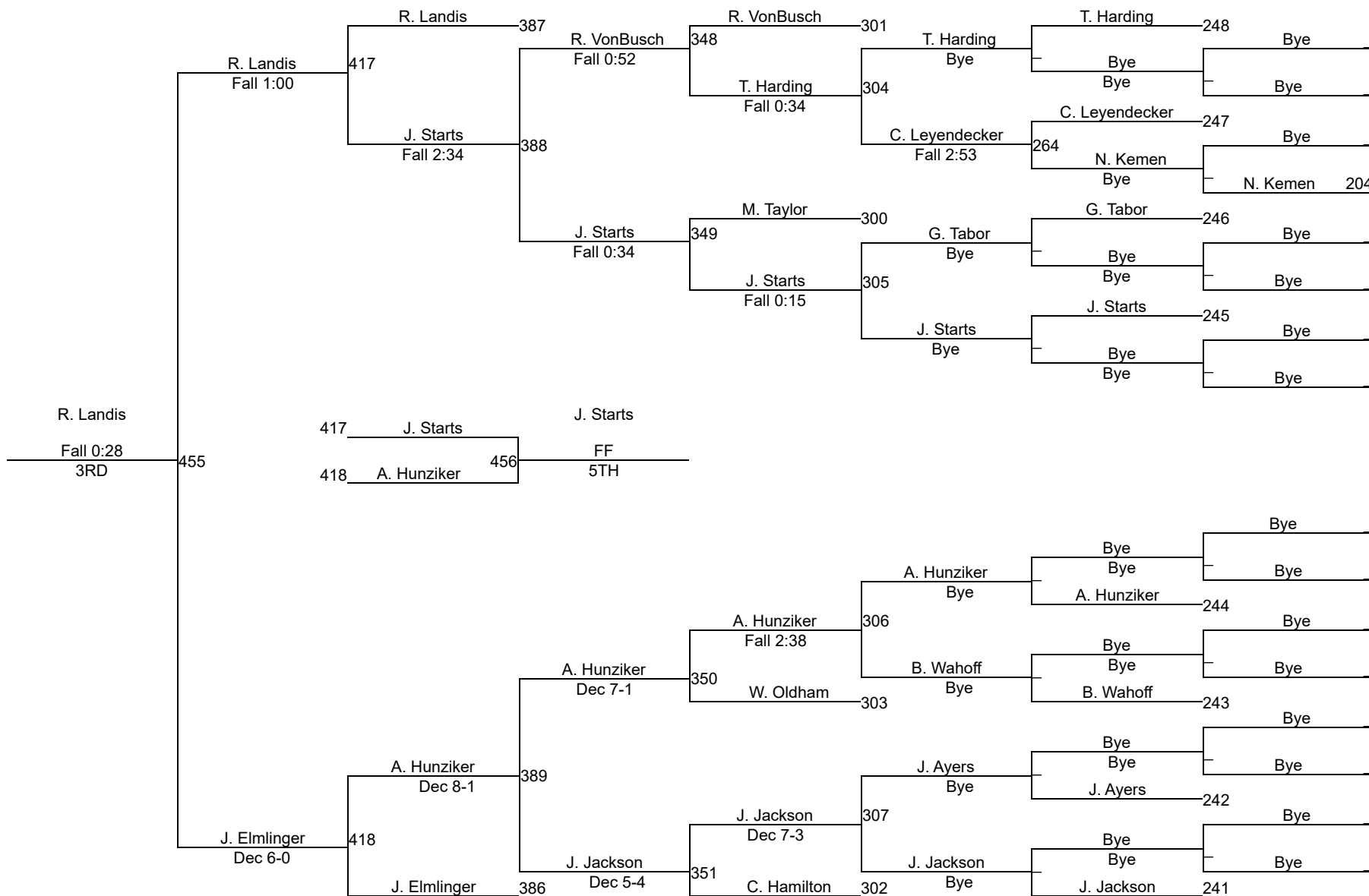

2025 OAC Lakota West GS District

Division III 85

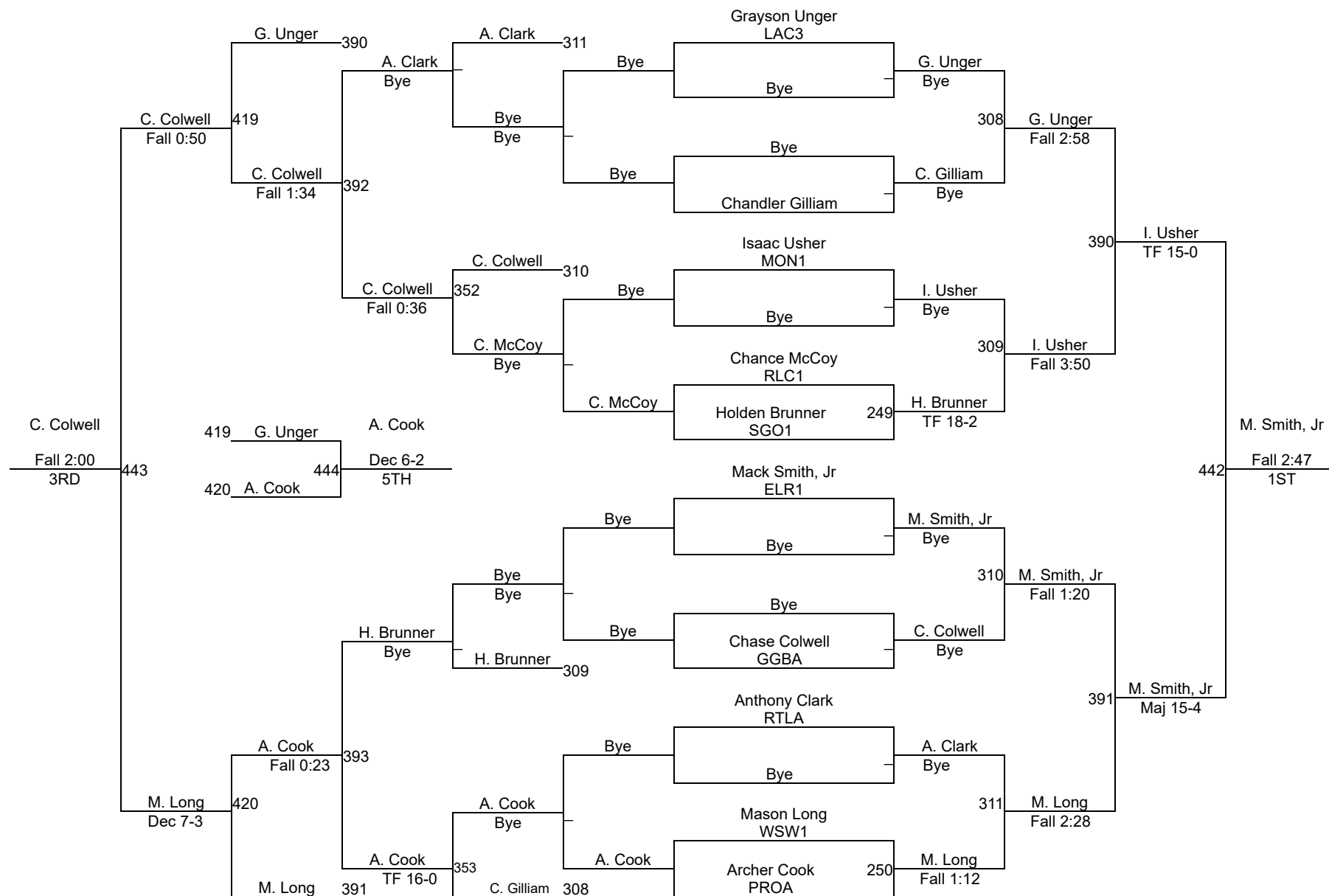

2025 OAC Lakota West GS District

Division III 95

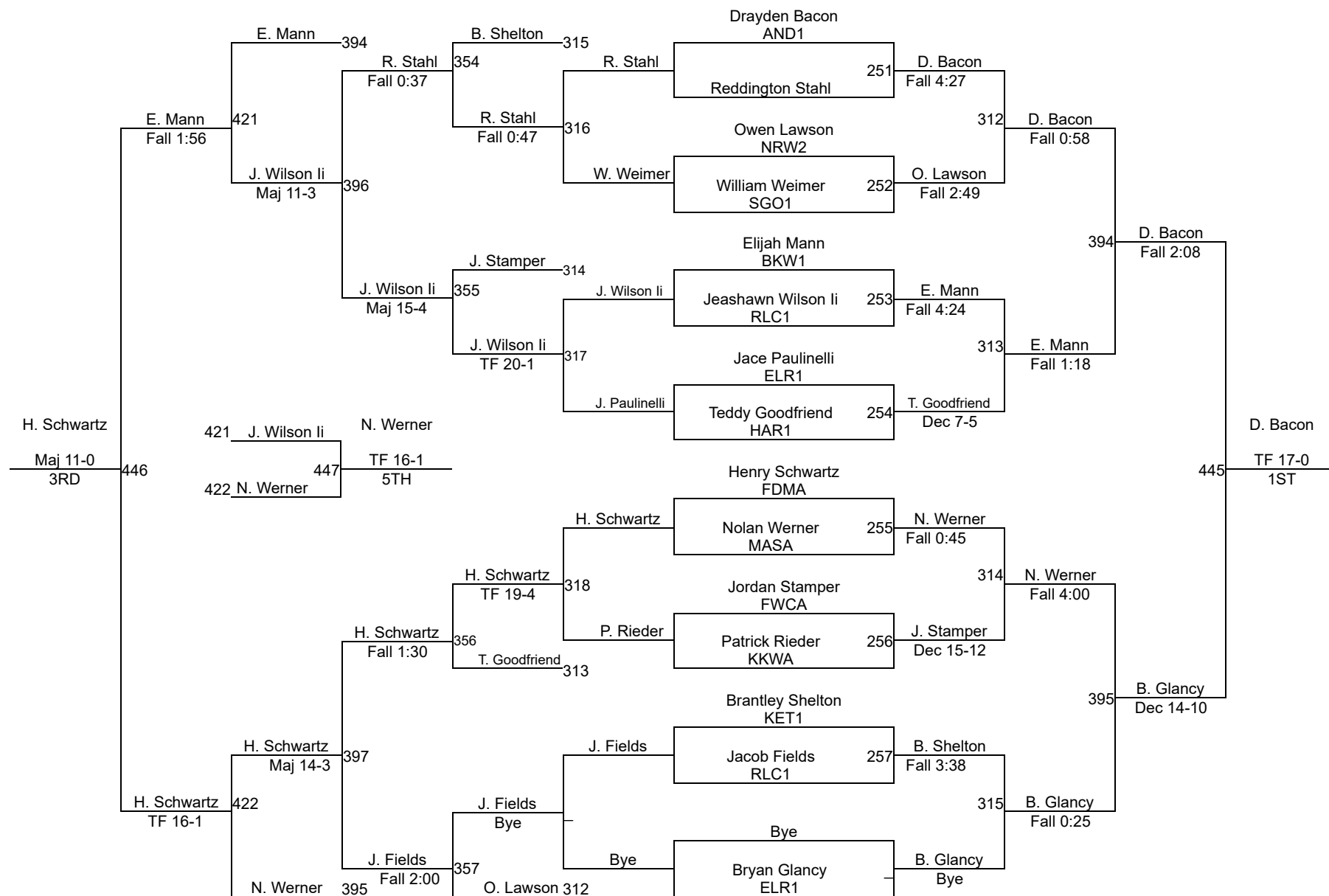

2025 OAC Lakota West GS District

Division III 110

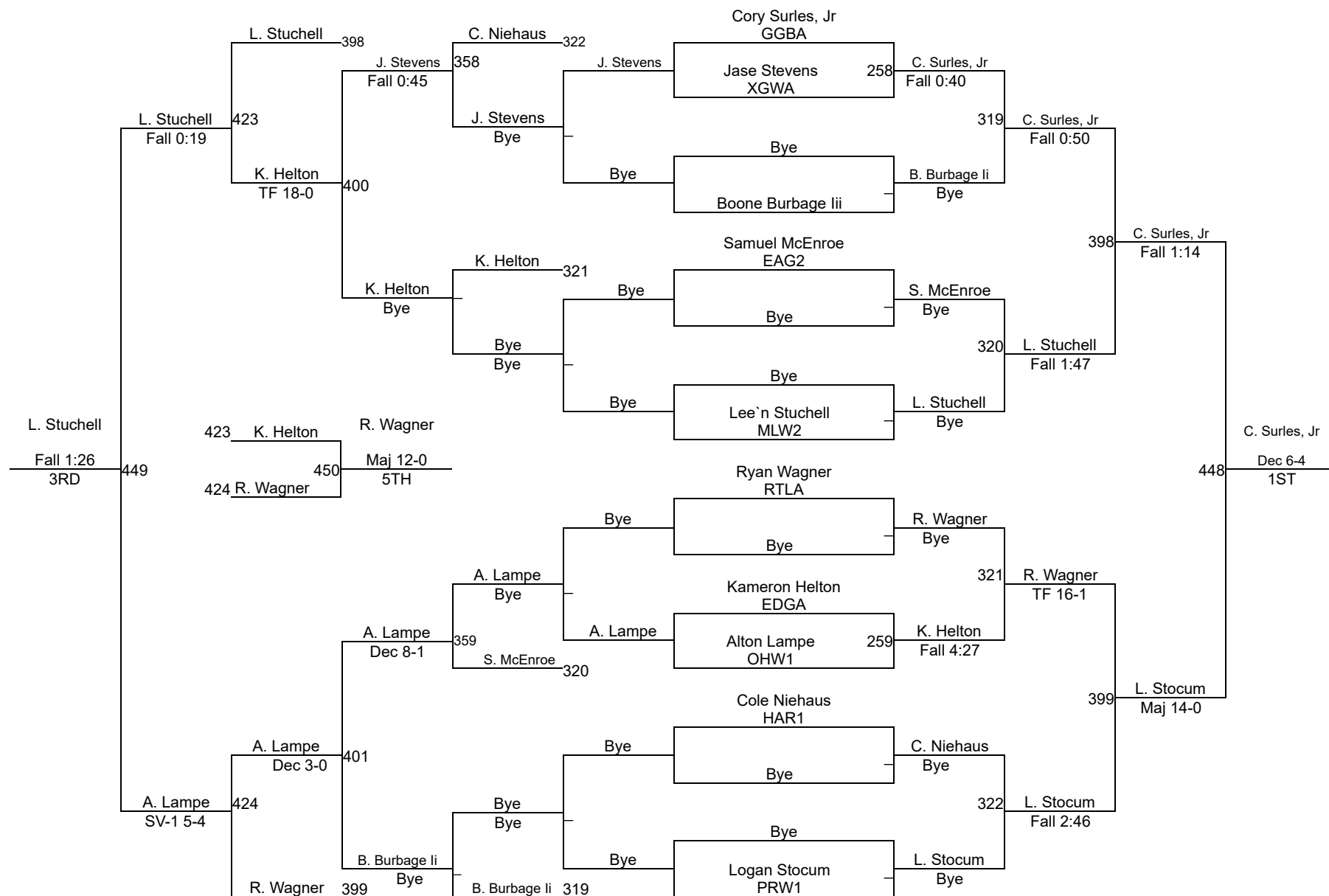

2025 OAC Lakota West GS District

Division III 130

Round 1

Ethan Watters ELR1	Ethan Watters ELR1 Dec 6-1
Michael Adkins MOE1	205

Landon Schussler SGO1	Landon Schussler SGO1 Fall 1:47
Beckett Kirschbaum CNRA	206

E. Watters (ELR1)
1ST

Round 2

Harrison Stafford TRWA	Harrison Stafford TRWA Fall 2:15
Beckett Kirschbaum CNRA	265

Ethan Watters ELR1	Ethan Watters ELR1 OT 10-7
Landon Schussler SGO1	266

L. Schussler (SGO1)
2ND

Round 3

Harrison Stafford TRWA	Landon Schussler SGO1 Fall 0:47
Landon Schussler SGO1	360

Michael Adkins MOE1	Michael Adkins MOE1 Maj 11-0
Beckett Kirschbaum CNRA	361

M. Adkins (MOE1)
3RD

Round 4

Harrison Stafford TRWA	Michael Adkins MOE1 TF 15-0
Michael Adkins MOE1	402

Ethan Watters ELR1	Ethan Watters ELR1 Fall 0:51
Beckett Kirschbaum CNRA	403

H. Stafford (TRWA)
4TH

Round 5

Harrison Stafford TRWA	Ethan Watters ELR1 Fall 1:08
Ethan Watters ELR1	425

Michael Adkins MOE1	Landon Schussler SGO1 OT 13-10
Landon Schussler SGO1	426

B. Kirschbaum (CNRA)
5TH

2025 OAC Lakota West GS District

Division III 160

Round 1

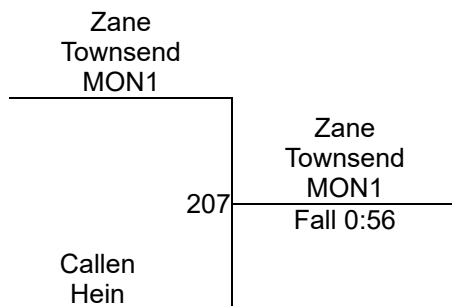

Round 2

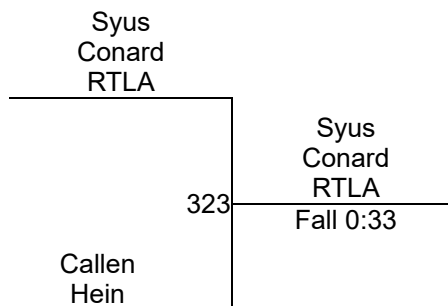

Round 3

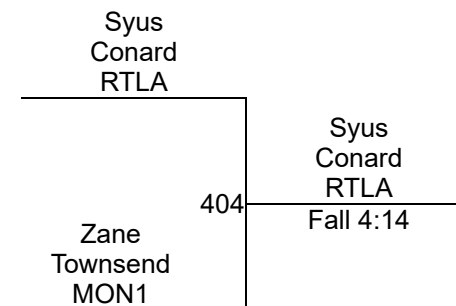

S. Conard (RTLA)
1ST

Z. Townsend (MON1)
2ND

C. Hein ()
3RD

2025 OAC Lakota West GS District

Division IV 65

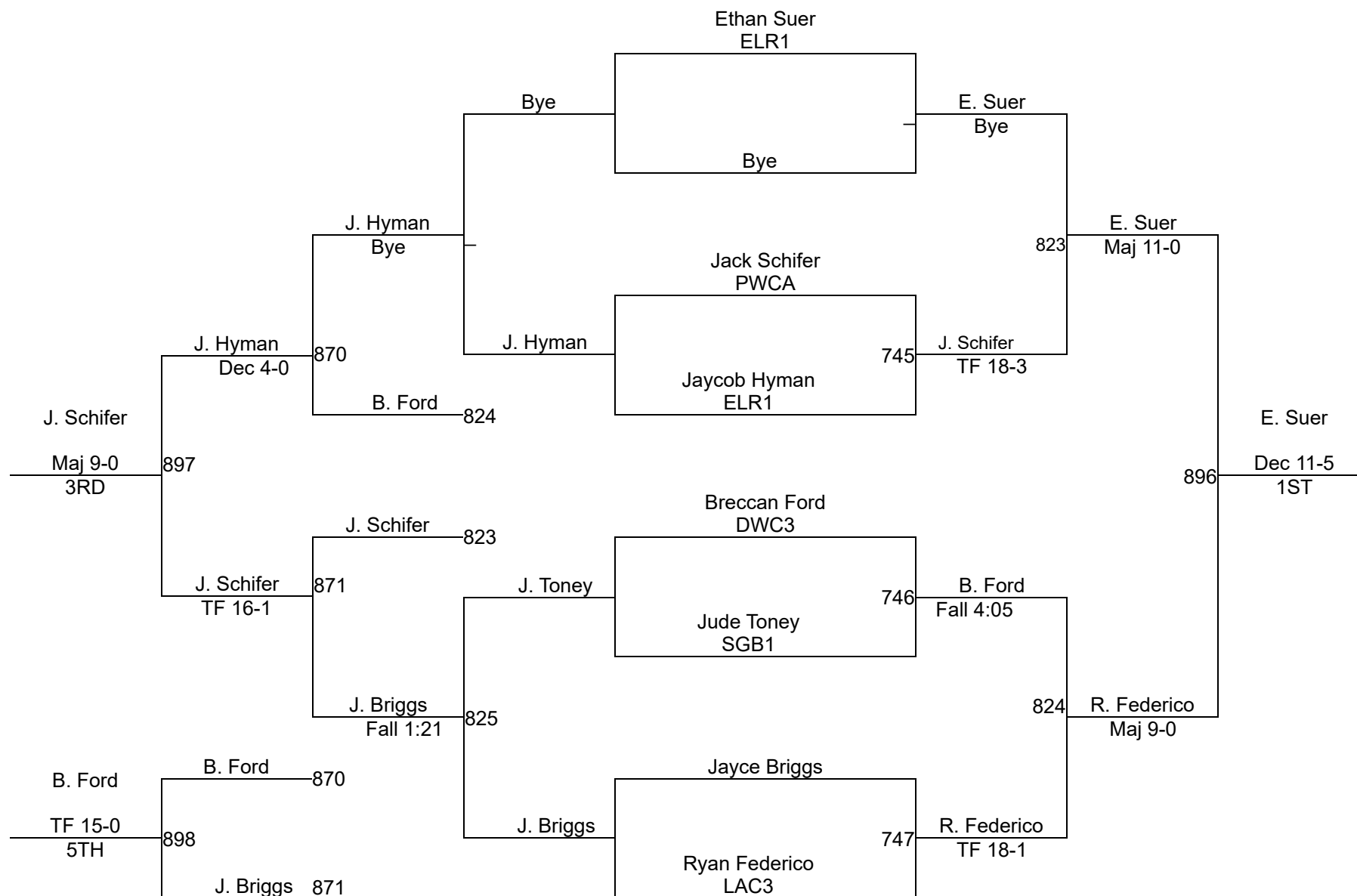

2025 OAC Lakota West GS District

Division IV 70

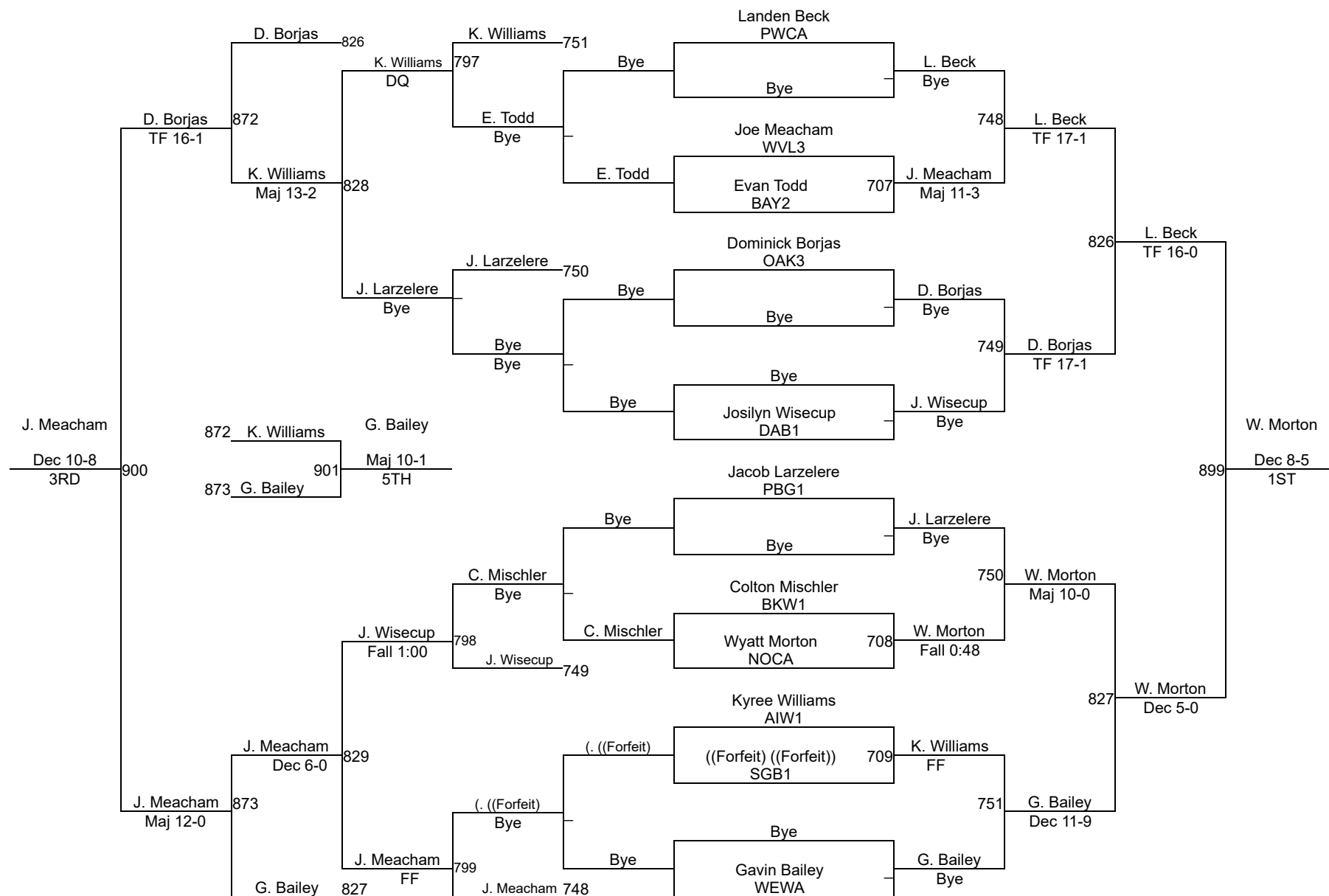

2025 OAC Lakota West GS District

Division IV 75

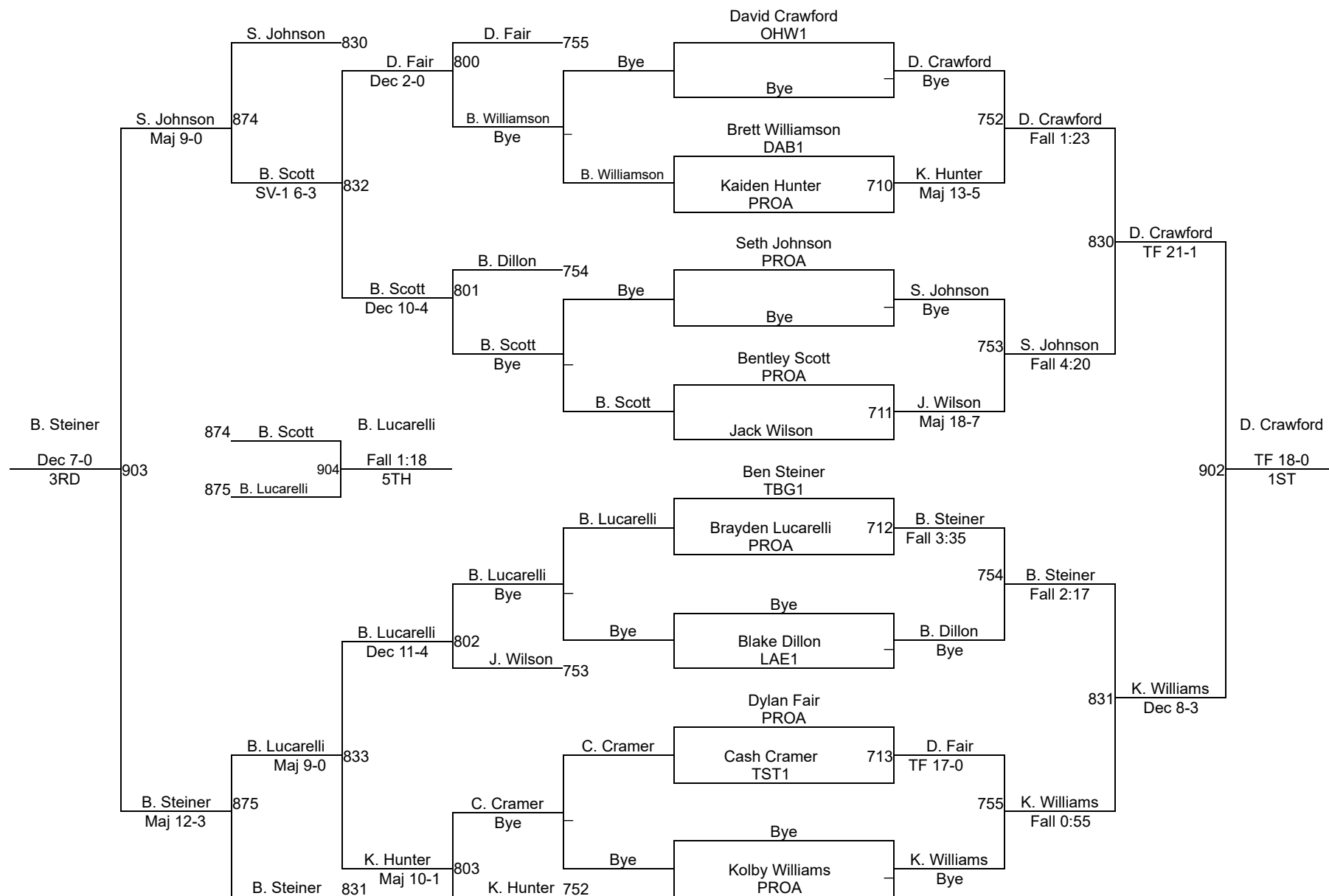

2025 OAC Lakota West GS District

Division IV 80

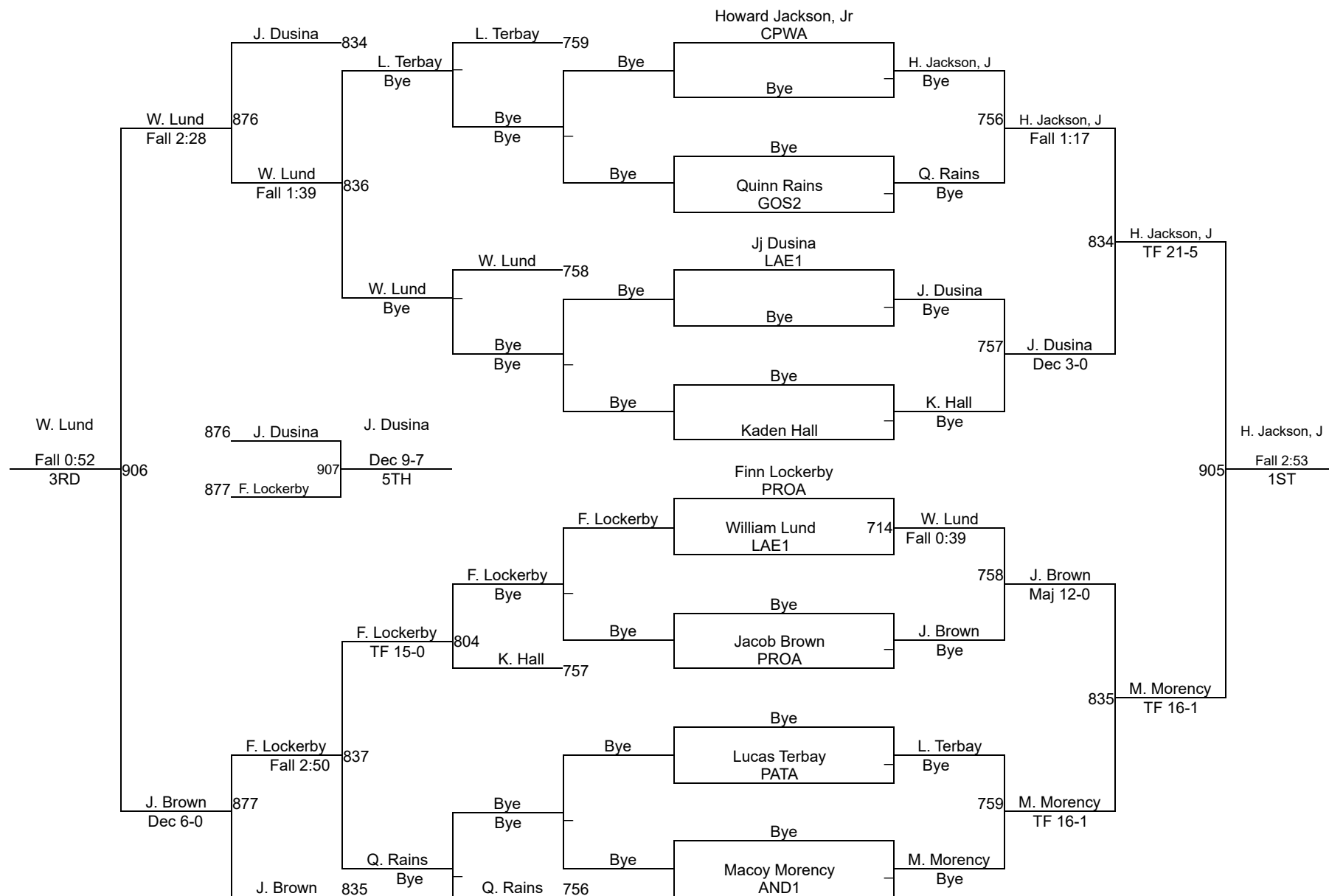

2025 OAC Lakota West GS District

Division IV 85

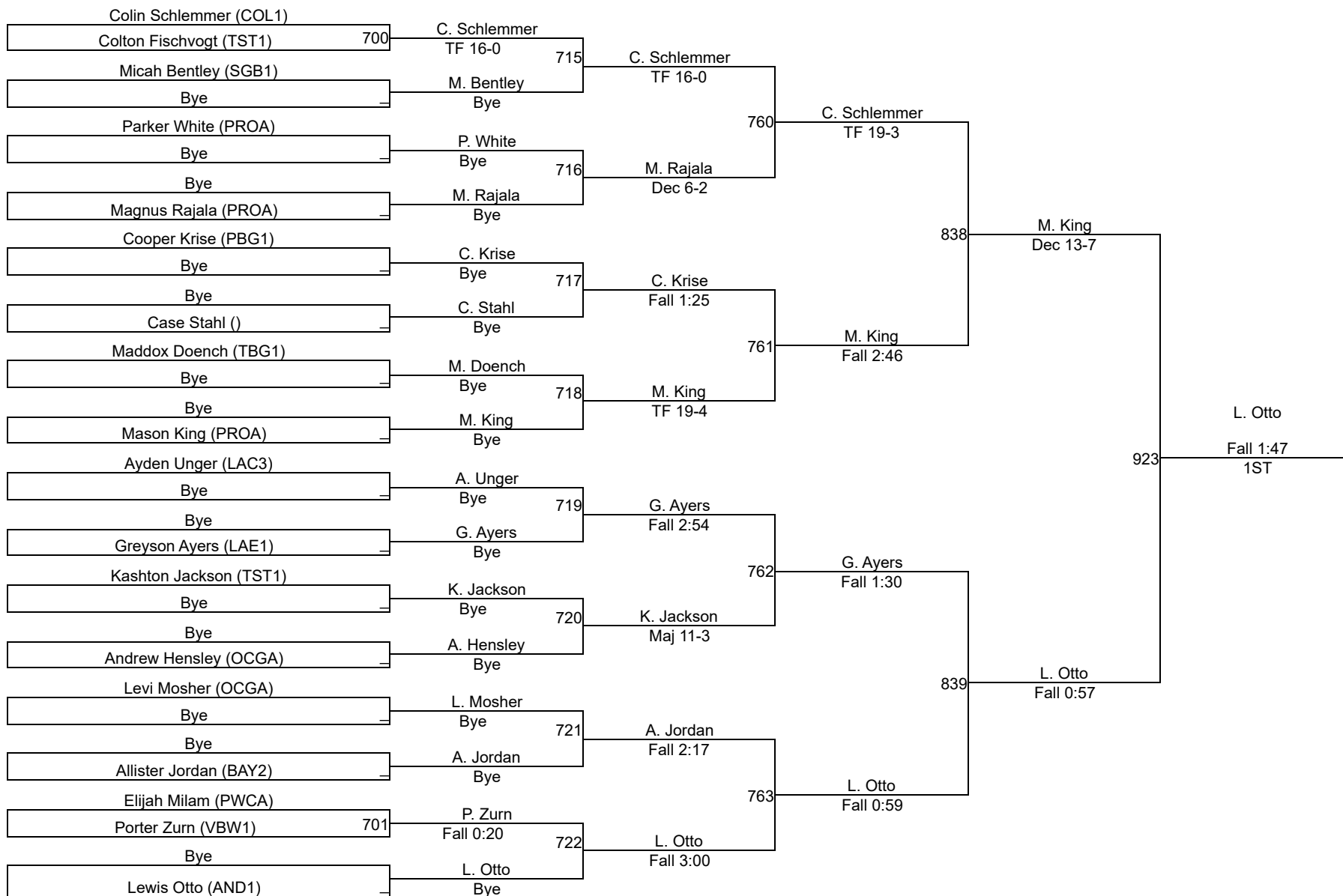

Division IV 85

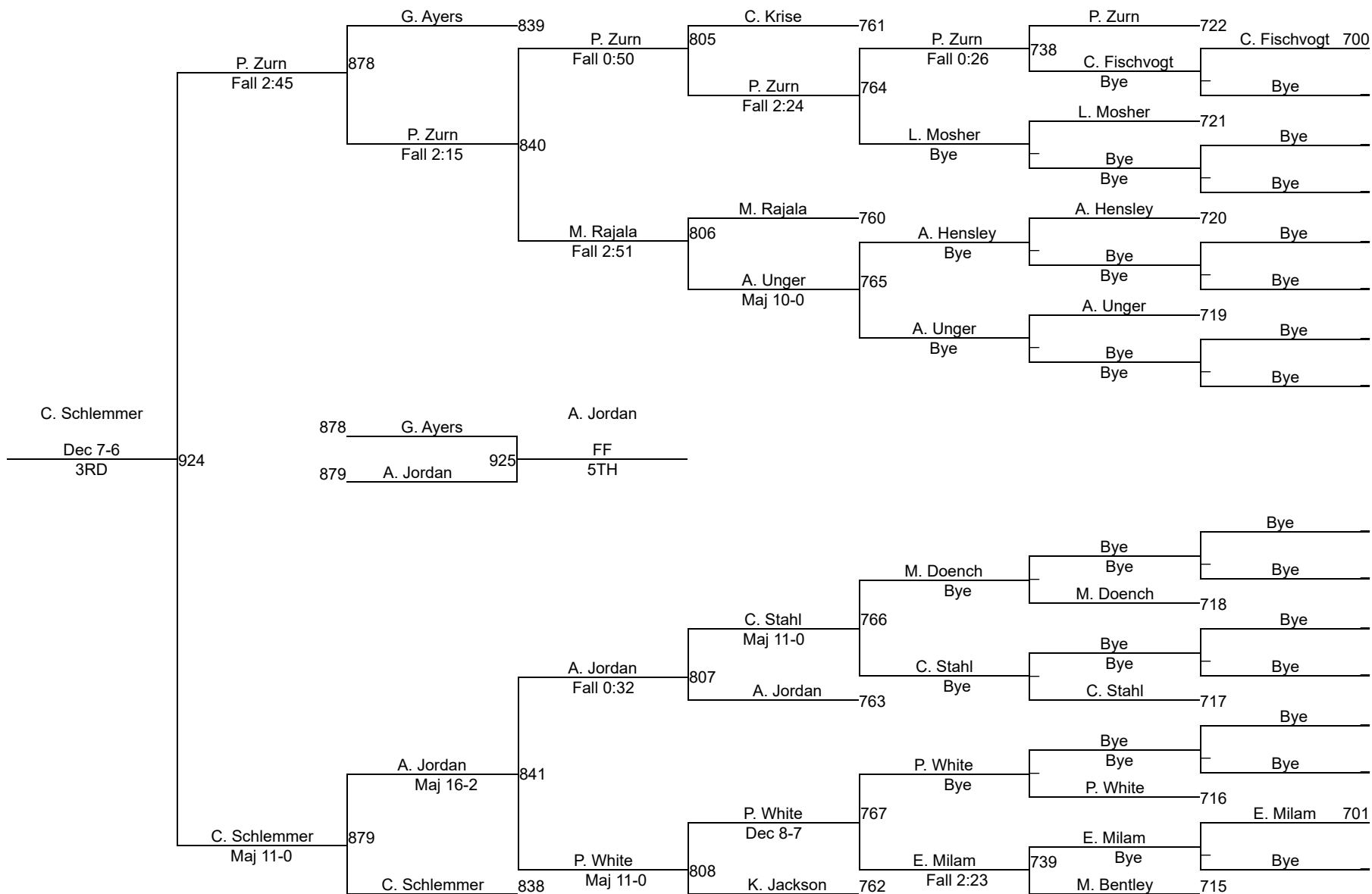

2025 OAC Lakota West GS District

Division IV 90

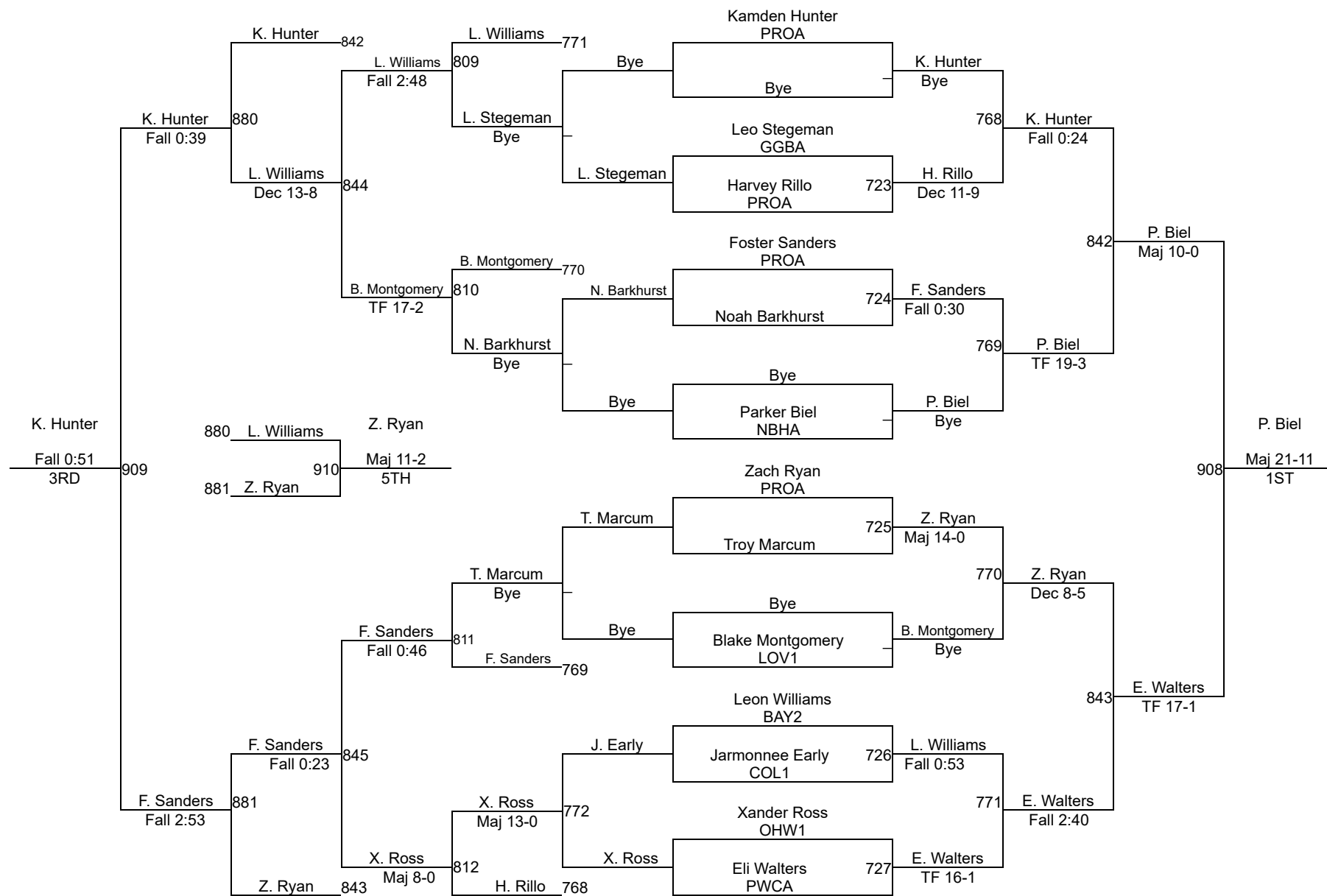

2025 OAC Lakota West GS District

Division IV 95

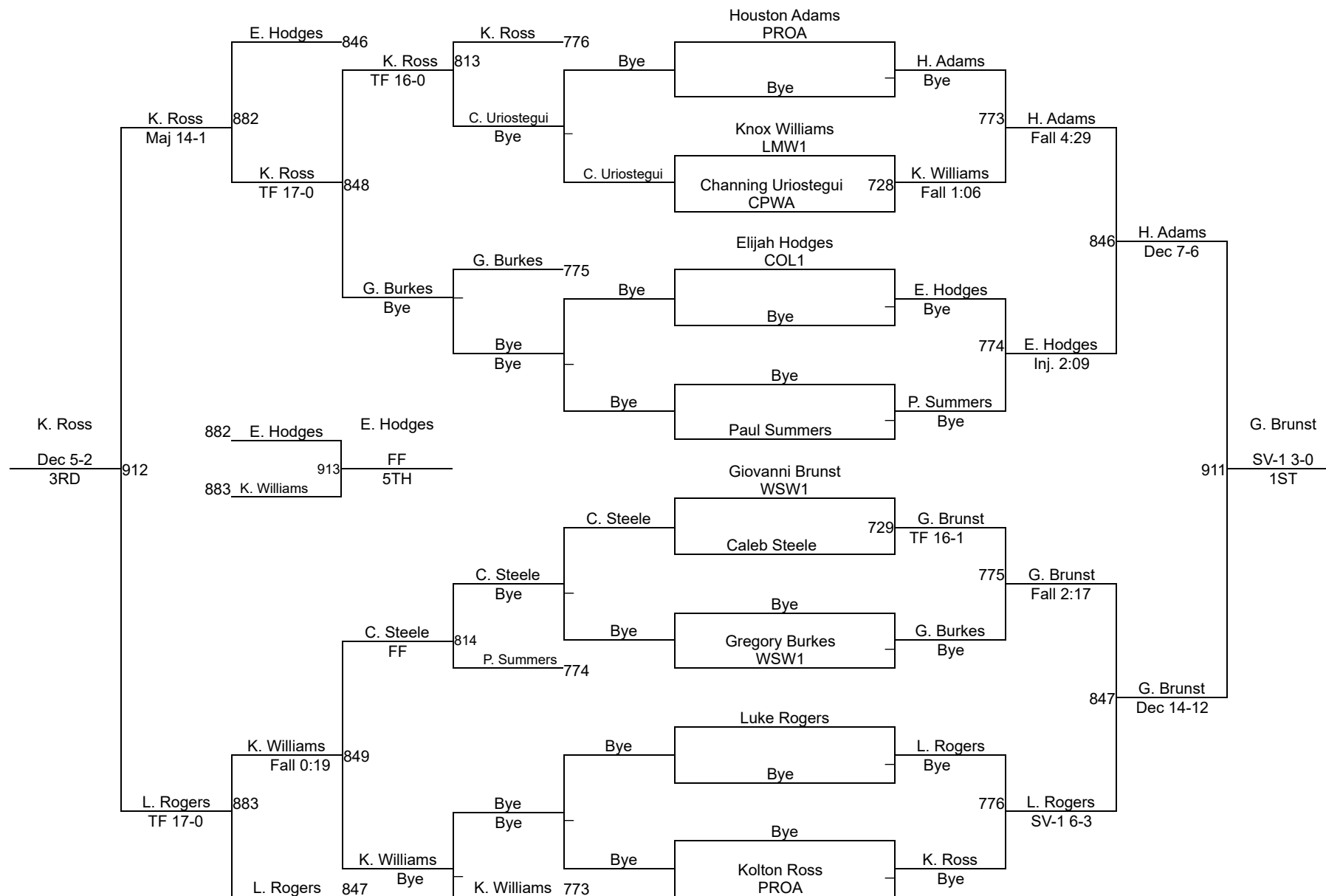

2025 OAC Lakota West GS District

Division IV 100

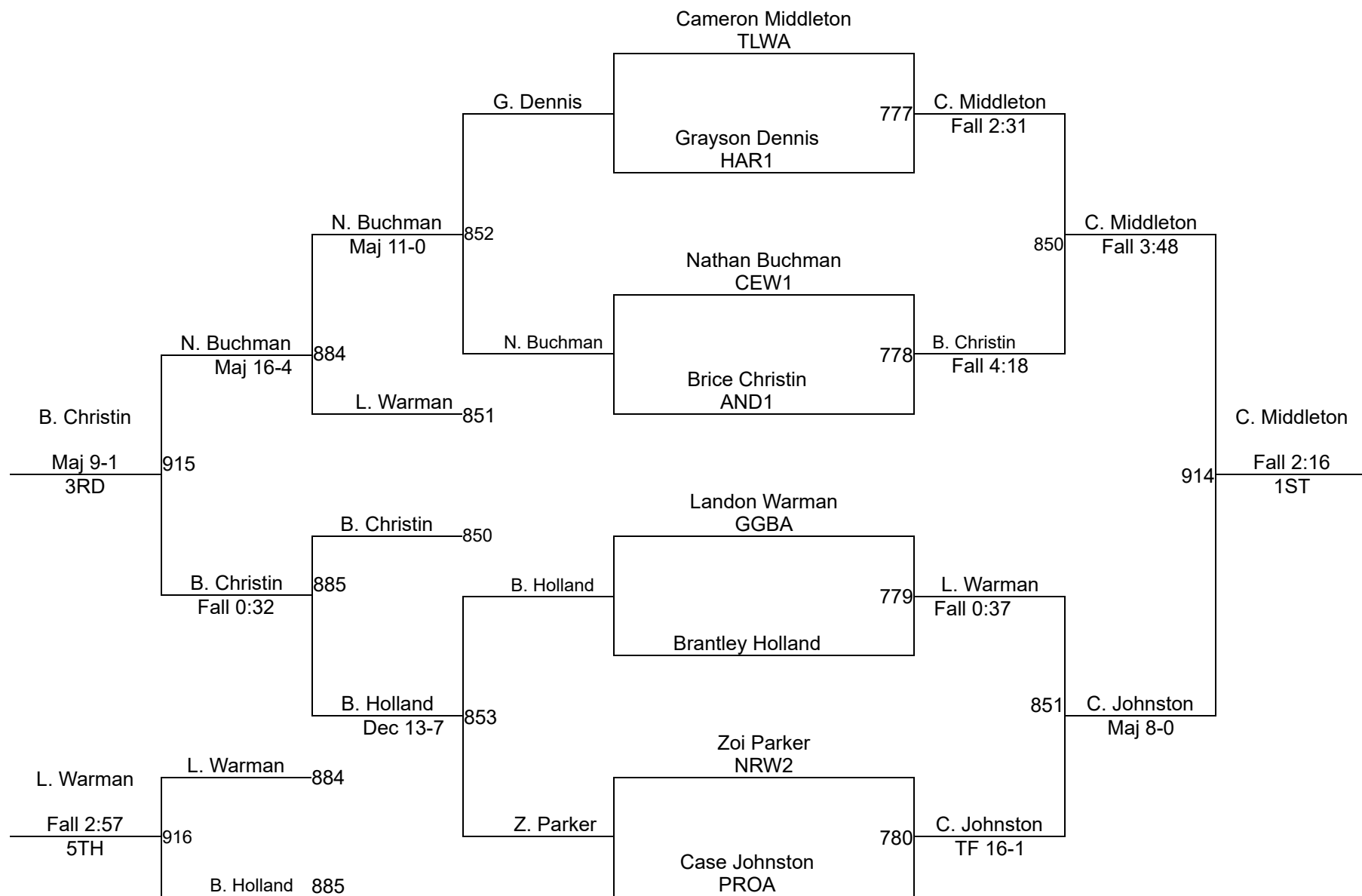

2025 OAC Lakota West GS District

Division IV 110

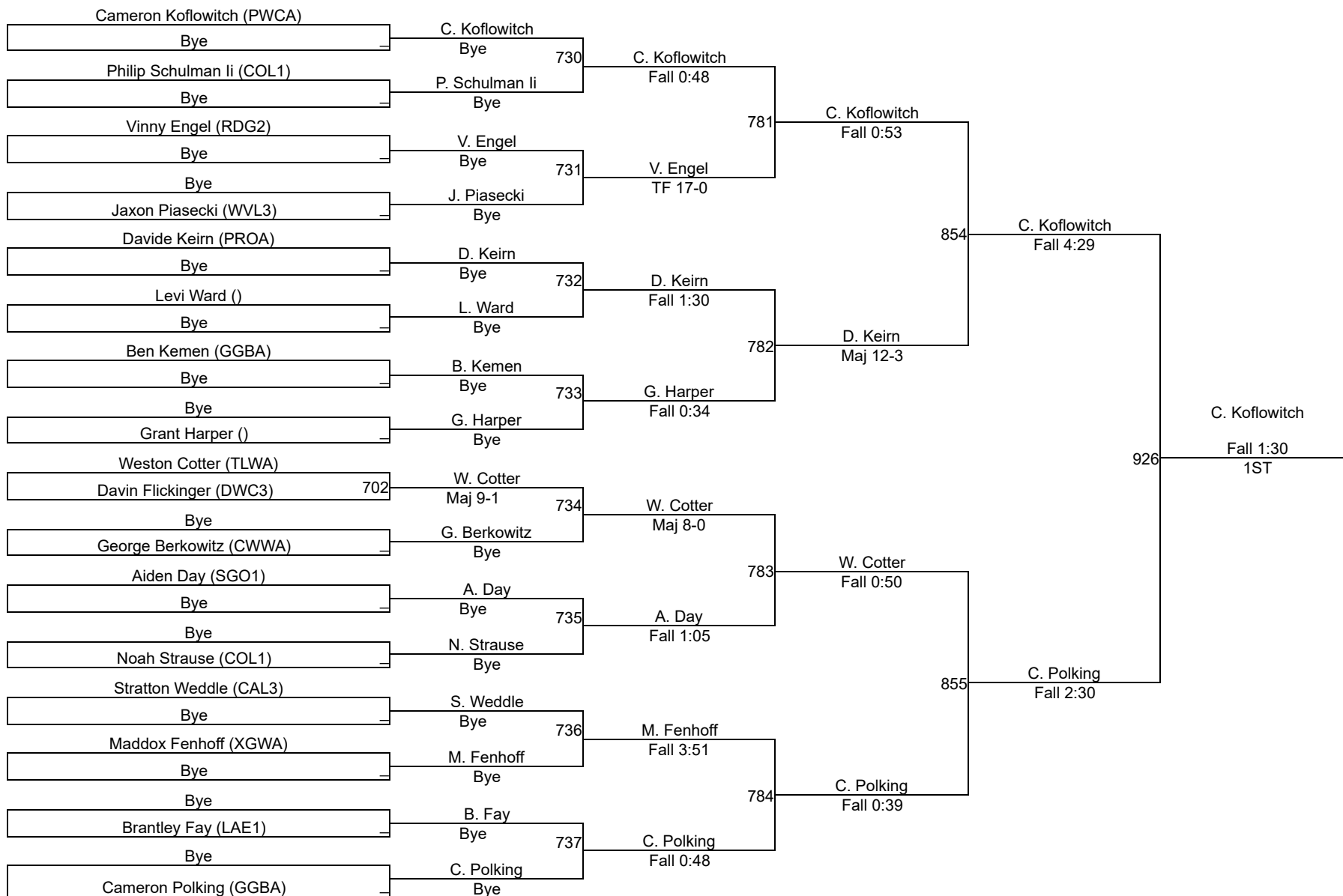

Division IV 110

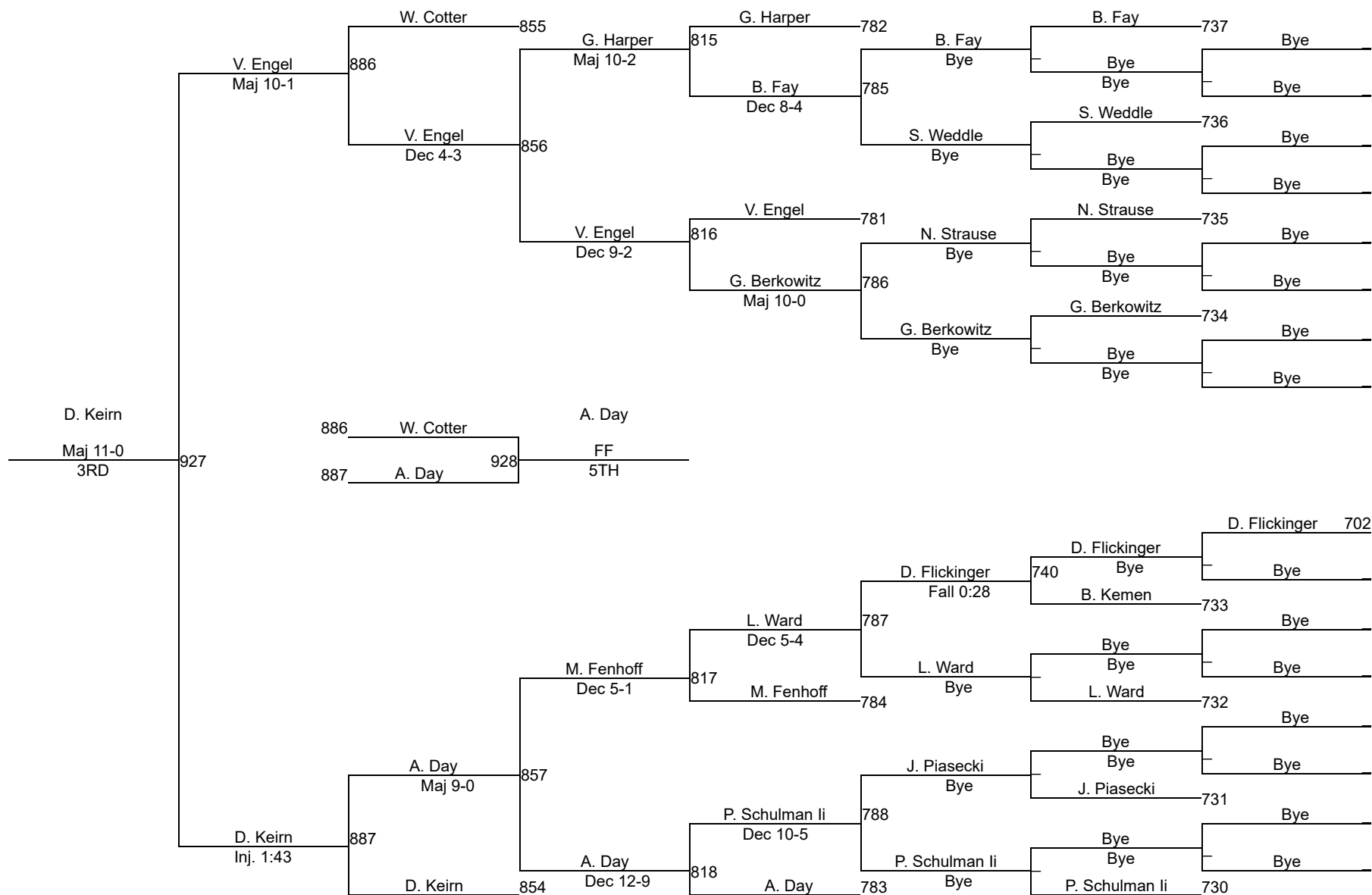

2025 OAC Lakota West GS District

Division IV 120

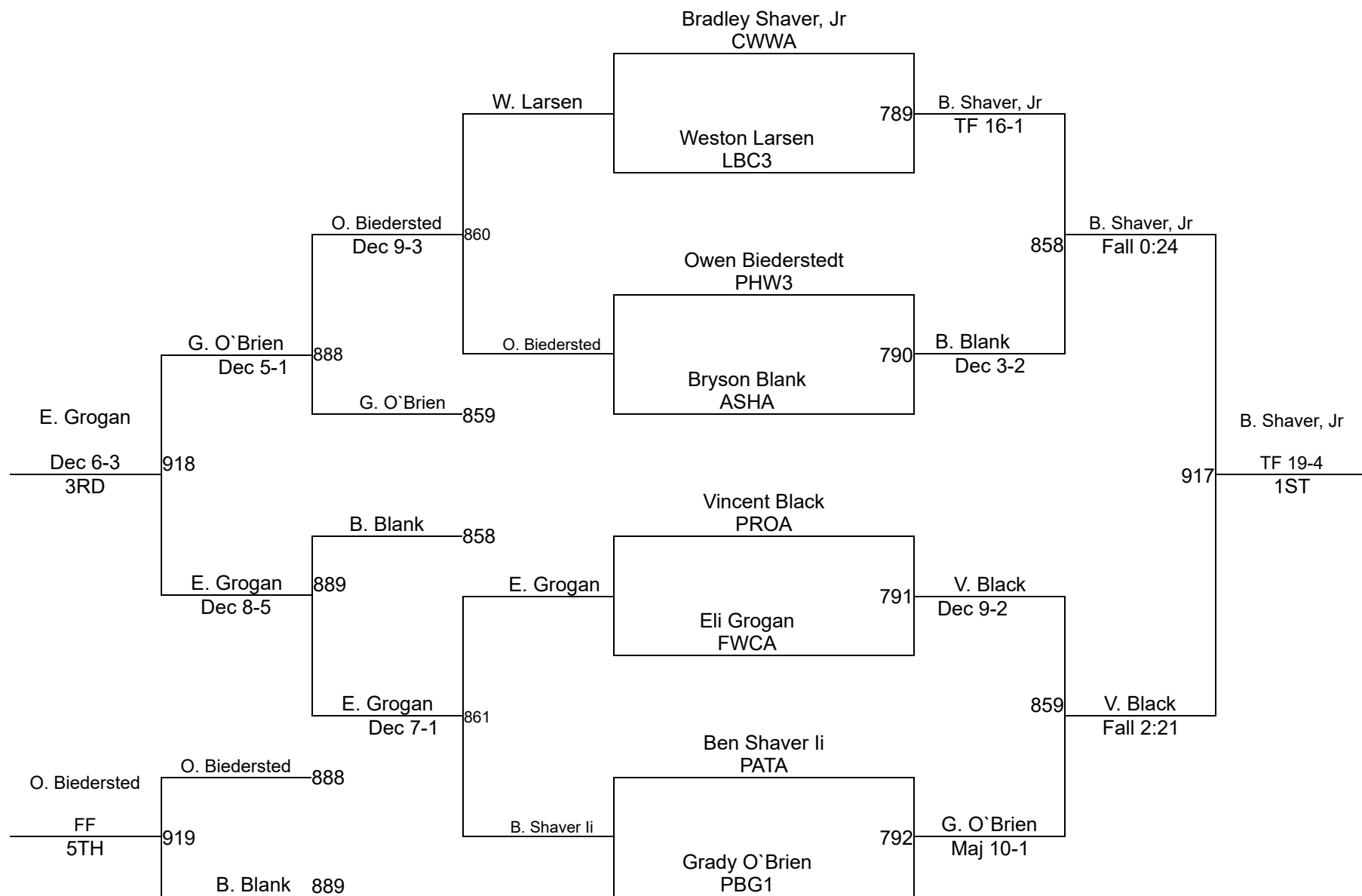

2025 OAC Lakota West GS District

Division IV 130

Round 1

Rory Webb BKW1		Brandon Laurell li LEO1
Brandon Laurell li LEO1	703	Fall 0:45

John Freeman Jr BTLA		John Freeman Jr BTLA
Rique Robinson RLC1	704	Fall 0:42

I. Goodman (NOCA)
1ST

Round 2

Isaac Goodman NOCA		Isaac Goodman NOCA
Rique Robinson RLC1	741	Fall 2:28

Rory Webb BKW1		John Freeman Jr BTLA
John Freeman Jr BTLA	742	Fall 0:42

J. Freeman Jr (BTLA)
2ND

Round 3

Isaac Goodman NOCA		Isaac Goodman NOCA
John Freeman Jr BTLA	819	Fall 2:41

Brandon Laurell li LEO1		Brandon Laurell li LEO1
Rique Robinson RLC1	820	Fall 1:00

B. Laurell li (LEO1)
3RD

Round 4

Isaac Goodman NOCA		Isaac Goodman NOCA
Brandon Laurell li LEO1	862	Fall 0:46

Rory Webb BKW1		Rory Webb BKW1
Rique Robinson RLC1	863	Fall 2:25

R. Webb (BKW1)
4TH

Round 5

Isaac Goodman NOCA		Isaac Goodman NOCA
Rory Webb BKW1	890	Fall 0:22

Brandon Laurell li LEO1		John Freeman Jr BTLA
John Freeman Jr BTLA	891	Fall 1:19

R. Robinson (RLC1)
5TH

2025 OAC Lakota West GS District

Division IV 140

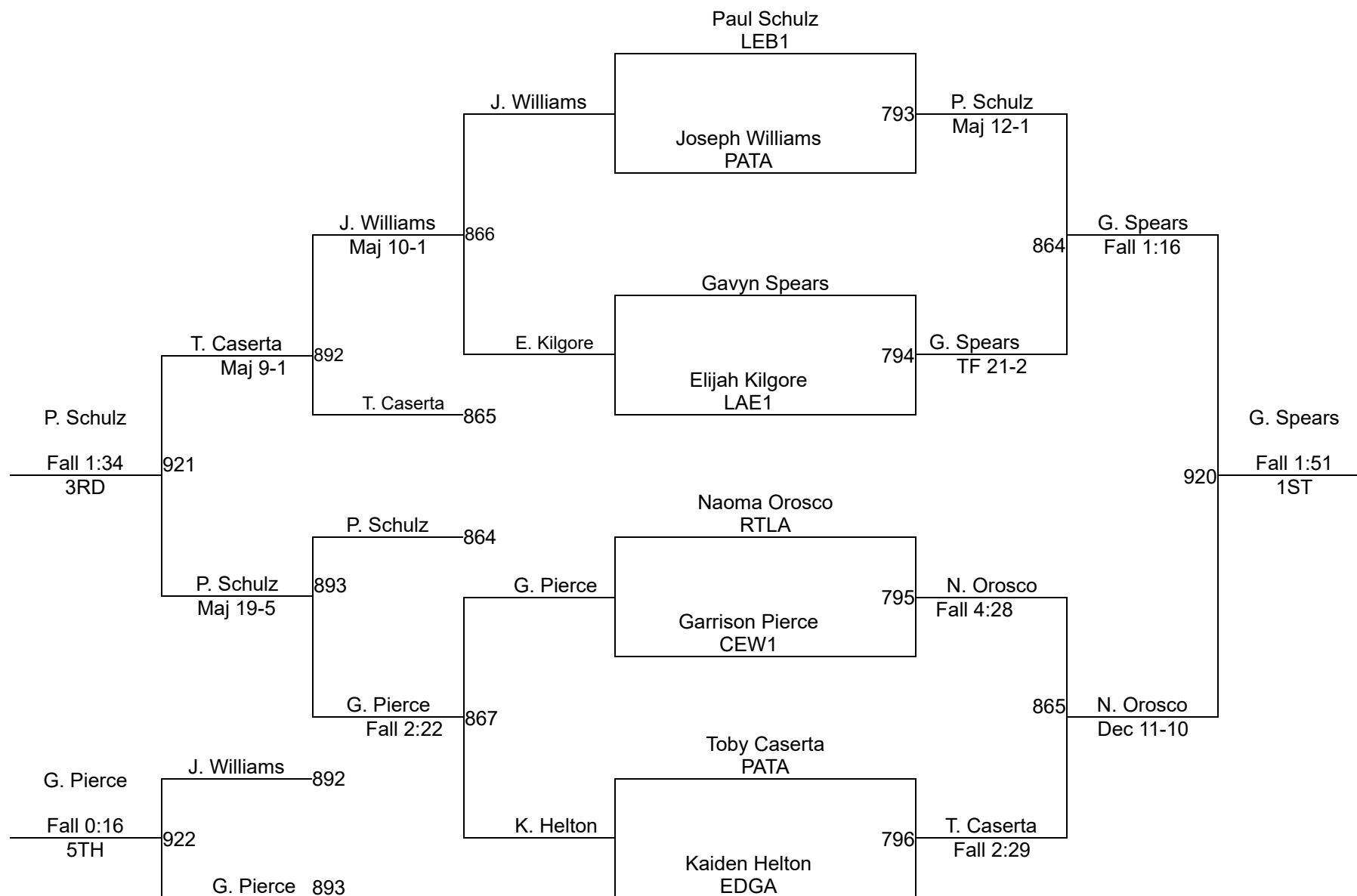

2025 OAC Lakota West GS District

Division IV 180

Round 1

Garrett Plummer PROA	Rex Williamson OHW1
Rex Williamson OHW1	Fall 1:18
705	

Samuel Boswell BAY2	Rondel Sanders Iii
Rondel Sanders Iii	Fall 1:16
706	

C. Maiani (CEW1)
1ST

Round 2

Charlie Maiani CEW1	Charlie Maiani CEW1
Rondel Sanders Iii	Fall 2:41
743	

Garrett Plummer PROA	Garrett Plummer PROA
Samuel Boswell BAY2	Fall 2:24
744	

R. Sanders Iii ()
2ND

Round 3

Charlie Maiani CEW1	Charlie Maiani CEW1
Samuel Boswell BAY2	Fall 2:42
821	

Rex Williamson OHW1	Rondel Sanders Iii
Rondel Sanders Iii	Maj 11-1
822	

R. Williamson (OHW1)
3RD

Round 4

Charlie Maiani CEW1	Charlie Maiani CEW1
Rex Williamson OHW1	Fall 1:01
868	

Garrett Plummer PROA	Rondel Sanders Iii
Rondel Sanders Iii	TF 21-6
869	

G. Plummer (PROA)
4TH

Round 5

Charlie Maiani CEW1	Charlie Maiani CEW1
Garrett Plummer PROA	Fall 1:17
894	

Rex Williamson OHW1	Rex Williamson OHW1
Samuel Boswell BAY2	Fall 0:42
895	

S. Boswell (BAY2)
5TH

