

Turkey Takedown-OACPts-Open/Novice

Divison 1 Novice 35-38

1

Round 1

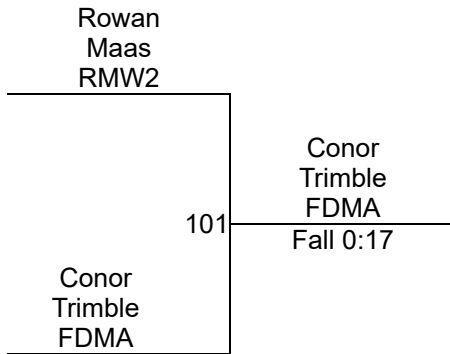

Round 2

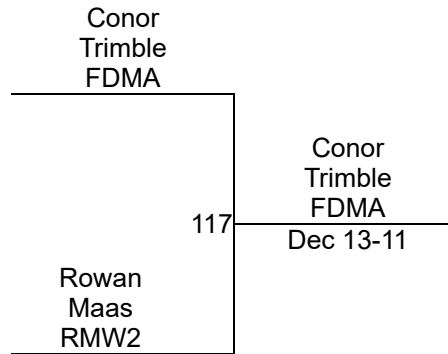

Round 3

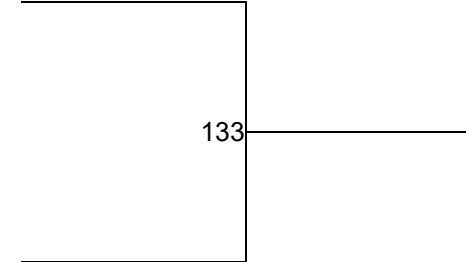

C. Trimble (FDMA)
1ST

R. Maas (RMW2)
2ND

Turkey Takedown-OACPts-Open/Novice

Divison 1 Novice 40-43

1

Round 1

Sawyer Holt SWCA		Mateo Dombrowsky EWO3	102	Mateo Dombrowsky EWO3	Fall 0:09
------------------------	--	-----------------------------	-----	-----------------------------	-----------

Elias Zenowiz RMW2		Tatum Reinbolt OAK3	103	Tatum Reinbolt OAK3	Fall 0:23
--------------------------	--	---------------------------	-----	---------------------------	-----------

Round 2

Sawyer Holt SWCA		Tatum Reinbolt OAK3	118	Tatum Reinbolt OAK3	Fall 0:20
------------------------	--	---------------------------	-----	---------------------------	-----------

Elias Zenowiz RMW2		Mateo Dombrowsky EWO3	119	Mateo Dombrowsky EWO3	Fall 0:20
--------------------------	--	-----------------------------	-----	-----------------------------	-----------

Round 3

Sawyer Holt SWCA		Elias Zenowiz RMW2	134	Elias Zenowiz RMW2	Fall 0:03
------------------------	--	--------------------------	-----	--------------------------	-----------

Tatum Reinbolt OAK3		Tatum Reinbolt OAK3	135	Tatum Reinbolt OAK3	Dec 16-12
---------------------------	--	---------------------------	-----	---------------------------	-----------

WRESTLERS

- S. Holt (SWCA)
- M. Dombrowsky (EWO3)
- E. Zenowiz (RMW2)
- T. Reinbolt (OAK3)

T. Reinbolt (OAK3)
1ST

M. Dombrowsky (EWO3)
2ND

E. Zenowiz (RMW2)
3RD

S. Holt (SWCA)
4TH

Turkey Takedown-OACPts-Open/Novice

Divison 1 Novice 42-45

1

Round 1

Roman Bork LEO1		Emmy Lashaway EWO3	
104		Fall 0:15	
Emmy Lashaway EWO3			

Axel Leal EWO3		Axel Leal EWO3	
105		Maj 10-2	
Odin Maas RMW2			

Round 2

Roman Bork LEO1		Odin Maas RMW2	
120		Fall 0:43	
Odin Maas RMW2			

Axel Leal EWO3		Axel Leal EWO3	
121		Fall 2:10	
Emmy Lashaway EWO3			

Round 3

Roman Bork LEO1		Axel Leal EWO3	
136		Fall 0:23	
Axel Leal EWO3			

Odin Maas RMW2		Emmy Lashaway EWO3	
137		Dec 10-8	
Emmy Lashaway EWO3			

WRESTLERS

- R. Bork (LEO1)
- E. Lashaway (EWO3)
- A. Leal (EWO3)
- O. Maas (RMW2)

A. Leal (EWO3)

1ST

E. Lashaway (EWO3)

2ND

O. Maas (RMW2)

3RD

R. Bork (LEO1)

4TH

Turkey Takedown-OACPts-Open/Novice

Divison 1 Novice 46-48

1

Round 1

Tarric Jomaa JPW		Tarric Jomaa JPW
Zander Schiering PBG1	106	Fall 0:11

Kolton Jones PBG1		Kolton Jones PBG1
Finn Guice RMW2	107	Fall 0:30

Round 2

Tarric Jomaa JPW		Tarric Jomaa JPW
Finn Guice RMW2	122	Fall 0:22

Kolton Jones PBG1		Kolton Jones PBG1
Zander Schiering PBG1	123	Fall 2:18

Round 3

Tarric Jomaa JPW		Tarric Jomaa JPW
Kolton Jones PBG1	138	Fall 2:00

Finn Guice RMW2		Zander Schiering PBG1
Zander Schiering PBG1	139	Fall 1:13

WRESTLERS

- T. Jomaa (JPW)
- Z. Schiering (PBG1)
- K. Jones (PBG1)
- F. Guice (RMW2)

T. Jomaa (JPW)
1ST

K. Jones (PBG1)
2ND

Z. Schiering (PBG1)
3RD

F. Guice (RMW2)
4TH

Turkey Takedown-OACPts-Open/Novice

Divison 1 Novice 51-55

1

Round 1

Owynn Herman RMW2		Sebastian Swartzmiller RMW2	
Sebastian Swartzmiller RMW2	108	Sebastian Swartzmiller RMW2	Fall 0:13

Ashton Castillo LEO1		Jace Miller RMW2	
Jace Miller RMW2	109	Jace Miller RMW2	TF 16-1

Round 2

Owynn Herman RMW2		Jace Miller RMW2	
Jace Miller RMW2	124	Jace Miller RMW2	Fall 2:43

Ashton Castillo LEO1		Sebastian Swartzmiller RMW2	
Sebastian Swartzmiller RMW2	125	Sebastian Swartzmiller RMW2	Fall 0:23

Round 3

Owynn Herman RMW2		Owynn Herman RMW2	
Ashton Castillo LEO1	140	Owynn Herman RMW2	Fall 2:57

Jace Miller RMW2		Sebastian Swartzmiller RMW2	
Sebastian Swartzmiller RMW2	141	Sebastian Swartzmiller RMW2	Fall 0:23

WRESTLERS

O. Herman (RMW2)

S. Swartzmiller (RMW2)

A. Castillo (LEO1)

J. Miller (RMW2)

S. Swartzmiller (RMW2)

1ST

J. Miller (RMW2)

2ND

O. Herman (RMW2)

3RD

A. Castillo (LEO1)

4TH

Turkey Takedown-OACPts-Open/Novice

Divison 1 Novice 84-84
1

Round 1

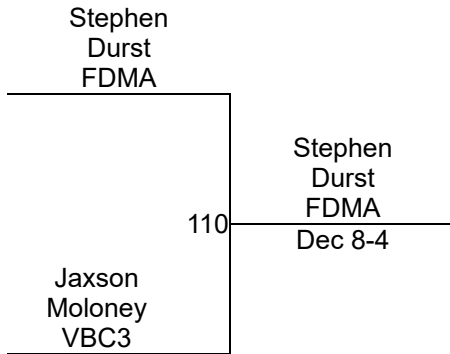

Round 2

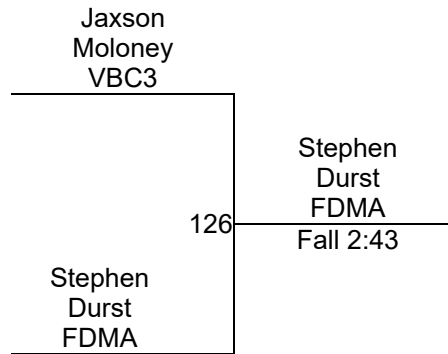

Round 3

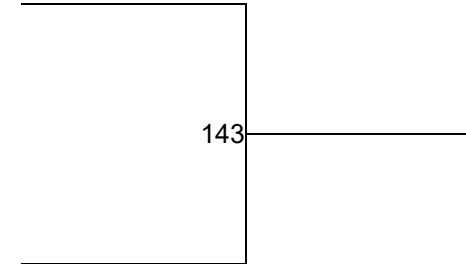

S. Durst (FDMA)
1ST

J. Moloney (VBC3)
2ND

Turkey Takedown-OACPts-Open/Novice

Division 2 Novice 42-45

1

Round 1

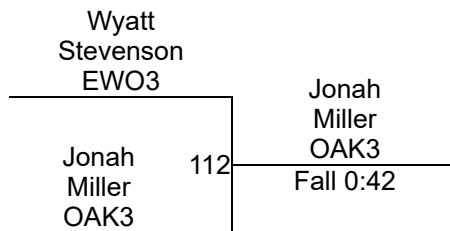
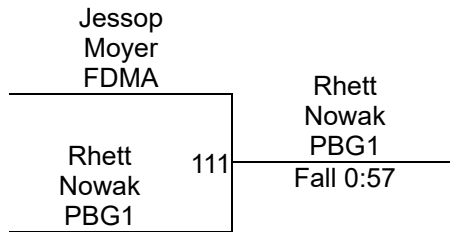

Round 2

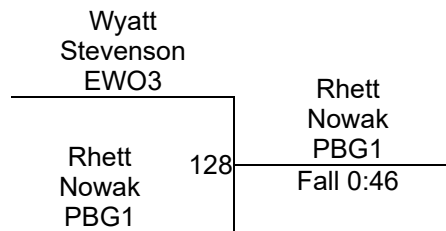
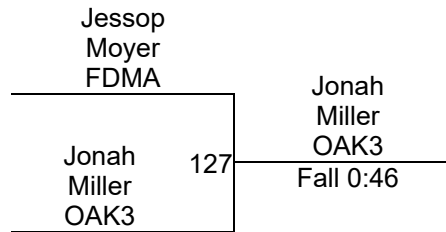

Round 3

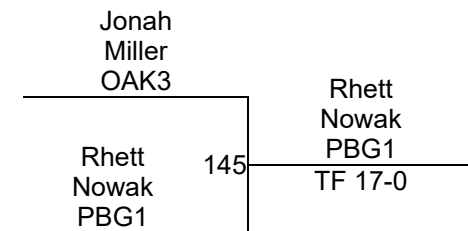
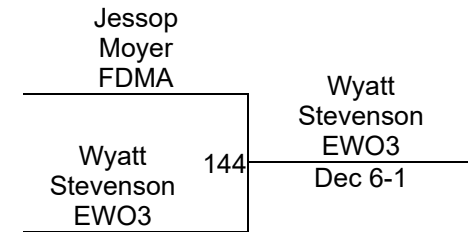

WRESTLERS

J. Moyer (FDMA)

R. Nowak (PBG1)

W. Stevenson (EWO3)

J. Miller (OAK3)

R. Nowak (PBG1)

1ST

J. Miller (OAK3)

2ND

W. Stevenson (EWO3)

3RD

J. Moyer (FDMA)

4TH

Turkey Takedown-OACPts-Open/Novice

Division 2 Novice 48-51

1

Round 1

Jose Martinez LEO1		Hendrix Powers VBC3	

Hendrix Powers VBC3	113		Inj. 0:17

Colton Hetherington JRP1		Jackson Bame ELM3	

Jackson Bame ELM3	114		Fall 0:10

Round 2

Jose Martinez LEO1		Jackson Bame ELM3	

Jackson Bame ELM3	129		MFF

Colton Hetherington JRP1		Hendrix Powers VBC3	

Hendrix Powers VBC3	130		Fall 0:12

Round 3

Jose Martinez LEO1		Colton Hetherington JRP1	

Colton Hetherington JRP1	146		MFF

Jackson Bame ELM3		Hendrix Powers VBC3	

Hendrix Powers VBC3	147		Fall 0:59

WRESTLERS

J. Martinez (LEO1)

H. Powers (VBC3)

C. Hetherington (JRP1)

J. Bame (ELM3)

H. Powers (VBC3)

1ST

J. Bame (ELM3)

2ND

C. Hetherington (JRP1)

3RD

J. Martinez (LEO1)

4TH

Turkey Takedown-OACPts-Open/Novice

Division 2 Novice 50-52

1

Round 1

Elijah Ramirez PBG1	115	Elijah Ramirez PBG1	Fall 0:41
Michael Violi EWO3			

Eddy Randazzo BAY2	116	Eddy Randazzo BAY2	Fall 2:00
Mason Orians JRP1			

Round 2

Elijah Ramirez PBG1	131	Elijah Ramirez PBG1	Fall 2:08
Mason Orians JRP1			

Eddy Randazzo BAY2	132	Eddy Randazzo BAY2	Fall 0:46
Michael Violi EWO3			

Round 3

Elijah Ramirez PBG1	148	Elijah Ramirez PBG1	Maj 17-9
Eddy Randazzo BAY2			

Mason Orians JRP1	149	Michael Violi EWO3	Dec 15-12
Michael Violi EWO3			

WRESTLERS

E. Ramirez (PBG1)

M. Violi (EWO3)

E. Randazzo (BAY2)

M. Orians (JRP1)

E. Ramirez (PBG1)

1ST

E. Randazzo (BAY2)

2ND

M. Violi (EWO3)

3RD

M. Orians (JRP1)

4TH

Turkey Takedown-OACPts-Open/Novice

Division 2 Novice 51-52

2

Round 1

David Bork LEO1		David Bork LEO1	
Dylan Gorsuch JRP1	201	Fall 1:26	

Landon Mullenix PBG1		Maximillion Jahns SHB1	
Maximillion Jahns SHB1	202	Fall 1:54	

Round 2

David Bork LEO1		David Bork LEO1	
Maximillion Jahns SHB1	217	TF 15-0	

Landon Mullenix PBG1		Dylan Gorsuch JRP1	
Dylan Gorsuch JRP1	218	Fall 1:00	

Round 3

David Bork LEO1		David Bork LEO1	
Landon Mullenix PBG1	233	TF 17-2	

Maximillion Jahns SHB1		Maximillion Jahns SHB1	
Dylan Gorsuch JRP1	234	Dec 15-9	

WRESTLERS

- D. Bork (LEO1)
- D. Gorsuch (JRP1)
- L. Mullenix (PBG1)
- M. Jahns (SHB1)

D. Bork (LEO1)

1ST

M. Jahns (SHB1)

2ND

D. Gorsuch (JRP1)

3RD

L. Mullenix (PBG1)

4TH

Turkey Takedown-OACPts-Open/Novice

Division 2 Novice 53-54

2

Round 1

Declan Rochowiak RMW2	203	Declan Rochowiak RMW2 Fall 0:57
Lucas Moon JFWC		

Mateo Mies LEO1	204	Mateo Mies LEO1 TF 15-0
Brandt Reinbolt OAK3		

Round 2

Declan Rochowiak RMW2	219	Declan Rochowiak RMW2 Fall 0:43
Brandt Reinbolt OAK3		

Mateo Mies LEO1	220	Mateo Mies LEO1 Dec 8-4
Lucas Moon JFWC		

Round 3

Declan Rochowiak RMW2	235	Declan Rochowiak RMW2 Fall 0:27
Mateo Mies LEO1		

Brandt Reinbolt OAK3	236	Lucas Moon JFWC Fall 0:38
Lucas Moon JFWC		

WRESTLERS

D. Rochowiak (RMW2)

L. Moon (JFWC)

M. Mies (LEO1)

B. Reinbolt (OAK3)

D. Rochowiak (RMW2)

1ST

M. Mies (LEO1)

2ND

L. Moon (JFWC)

3RD

B. Reinbolt (OAK3)

4TH

Turkey Takedown-OACPts-Open/Novice

Division 2 Novice 54-54

2

Round 1

Raiden Garcia LEO1	205	Beau Wendt EWO3	Fall 0:36
Beau Wendt EWO3			

Miles Williams BAY2	206	Cael Whitner PBG1	Fall 1:58
Cael Whitner PBG1			

Round 2

Raiden Garcia LEO1	221	Cael Whitner PBG1	Fall 0:28
Cael Whitner PBG1			

Miles Williams BAY2	222	Beau Wendt EWO3	Maj 13-4
Beau Wendt EWO3			

Round 3

Raiden Garcia LEO1	237	Miles Williams BAY2	Fall 2:49
Miles Williams BAY2			

Cael Whitner PBG1	238	Cael Whitner PBG1	Fall 2:00
Beau Wendt EWO3			

WRESTLERS

R. Garcia (LEO1)

B. Wendt (EWO3)

M. Williams (BAY2)

C. Whitner (PBG1)

C. Whitner (PBG1)

1ST

B. Wendt (EWO3)

2ND

M. Williams (BAY2)

3RD

R. Garcia (LEO1)

4TH

Turkey Takedown-OACPts-Open/Novice

Division 2 Novice 55-56

2

Round 1

Chase Molesky OAK3		Alex Siler LEO1		TF 15-0
Alex Siler LEO1	207			

Jack Jordan AVL1		Jack Jordan AVL1		Fall 0:19
Kaydin Cotterman EWO3	208			

Round 2

Chase Molesky OAK3		Kaydin Cotterman EWO3		Maj 12-3
Kaydin Cotterman EWO3	223			

Jack Jordan AVL1		Alex Siler LEO1		Maj 9-0
Alex Siler LEO1	224			

Round 3

Chase Molesky OAK3		Jack Jordan AVL1		TF 15-0
Jack Jordan AVL1	239			

Kaydin Cotterman EWO3		Alex Siler LEO1		Fall 1:22
Alex Siler LEO1	240			

WRESTLERS

C. Molesky (OAK3)

A. Siler (LEO1)

J. Jordan (AVL1)

K. Cotterman (EWO3)

A. Siler (LEO1)

1ST

J. Jordan (AVL1)

2ND

K. Cotterman (EWO3)

3RD

C. Molesky (OAK3)

4TH

Turkey Takedown-OACPts-Open/Novice

Division 2 Novice 56-57

2

Round 1

Kylie Portales OAK3		Amelia Curran LEO1
Amelia Curran LEO1	209	Fall 1:15

Rhett Yoder LCW3		Rhett Yoder LCW3
Hudson Powers VBC3	210	Maj 12-2

Round 2

Kylie Portales OAK3		Hudson Powers VBC3
Hudson Powers VBC3	225	Fall 2:00

Rhett Yoder LCW3		Rhett Yoder LCW3
Amelia Curran LEO1	226	TF 16-1

Round 3

Kylie Portales OAK3		Rhett Yoder LCW3
Rhett Yoder LCW3	241	Fall 0:44

Hudson Powers VBC3		Hudson Powers VBC3
Amelia Curran LEO1	242	TF 19-4

WRESTLERS

K. Portales (OAK3)

A. Curran (LEO1)

R. Yoder (LCW3)

H. Powers (VBC3)

R. Yoder (LCW3)

1ST

H. Powers (VBC3)

2ND

A. Curran (LEO1)

3RD

K. Portales (OAK3)

4TH

Turkey Takedown-OACPts-Open/Novice

Division 2 Novice 58-61

2

Round 1

Lincoln Cieslinski JFWC		Miguel Flores PBG1	
Miguel Flores PBG1	211	Fall 1:53	

Steven Houston JRP1		Steven Houston JRP1	
Ezekiel Hornsby SHB1	212	Fall 1:29	

Round 2

Lincoln Cieslinski JFWC		Lincoln Cieslinski JFWC	
Ezekiel Hornsby SHB1	227	Dec 7-6	

Steven Houston JRP1		Steven Houston JRP1	
Miguel Flores PBG1	228	Maj 11-3	

Round 3

Lincoln Cieslinski JFWC		Steven Houston JRP1	
Steven Houston JRP1	243	Fall 0:36	

Ezekiel Hornsby SHB1		Miguel Flores PBG1	
Miguel Flores PBG1	244	Fall 2:00	

WRESTLERS

L. Cieslinski (JFWC)

M. Flores (PBG1)

S. Houston (JRP1)

E. Hornsby (SHB1)

S. Houston (JRP1)

1ST

M. Flores (PBG1)

2ND

L. Cieslinski (JFWC)

3RD

E. Hornsby (SHB1)

4TH

Turkey Takedown-OACPts-Open/Novice

Division 2 Novice 61-67

2

Round 1

Levi Fincher JFWC	213	Levi Fincher JFWC Dec 11-9
Colton Huber EWO3		

Kai Ritchey PBG1	214	Kai Ritchey PBG1 Fall 0:20
Samirah Jomaa JRP1		

Round 2

Levi Fincher JFWC	229	Levi Fincher JFWC Fall 2:39
Samirah Jomaa JRP1		

Kai Ritchey PBG1	230	Kai Ritchey PBG1 Fall 0:17
Colton Huber EWO3		

Round 3

Levi Fincher JFWC	245	Kai Ritchey PBG1 Fall 1:16
Kai Ritchey PBG1		

Samirah Jomaa JRP1	246	Colton Huber EWO3 Fall 0:29
Colton Huber EWO3		

WRESTLERS

L. Fincher (JFWC)

C. Huber (EWO3)

K. Ritchey (PBG1)

S. Jomaa (JRP1)

K. Ritchey (PBG1)

1ST

L. Fincher (JFWC)

2ND

C. Huber (EWO3)

3RD

S. Jomaa (JRP1)

4TH

Turkey Takedown-OACPts-Open/Novice

Division 2 Novice 63-68

2

Round 1

Kailyn Holt SWCA		Derek Edgell PBG1	
Derek Edgell PBG1	215	Fall 0:13	

McCoy Stoner EWO3		Tyson McGill EMPA	
Tyson McGill EMPA	216	Dec 3-0	

Round 2

Kailyn Holt SWCA		Tyson McGill EMPA	
Tyson McGill EMPA	231	Fall 0:12	

McCoy Stoner EWO3		McCoy Stoner EWO3	
Derek Edgell PBG1	232	Fall 1:50	

Round 3

Kailyn Holt SWCA		McCoy Stoner EWO3	
McCoy Stoner EWO3	247	Fall 0:21	

Tyson McGill EMPA		Tyson McGill EMPA	
Derek Edgell PBG1	248	Maj 9-0	

WRESTLERS

K. Holt (SWCA)

D. Edgell (PBG1)

M. Stoner (EWO3)

T. McGill (EMPA)

T. McGill (EMPA)

1ST

M. Stoner (EWO3)

2ND

D. Edgell (PBG1)

3RD

K. Holt (SWCA)

4TH

Turkey Takedown-OACPts-Open/Novice

Division 2 Novice 68-70

3

Round 1

Lucas Kyer LEO1		Lucas Kyer LEO1
301	Fall 0:56	
Brantley Parrigan		

Graham Sentle EWO3		Graham Sentle EWO3
302	Fall 0:28	
Dwayne Croley OAK3		

Round 2

Lucas Kyer LEO1		Lucas Kyer LEO1
317	Fall 0:42	
Dwayne Croley OAK3		

Graham Sentle EWO3		Graham Sentle EWO3
318	Fall 2:20	
Brantley Parrigan		

Round 3

Lucas Kyer LEO1		Lucas Kyer LEO1
333	Dec 9-2	
Graham Sentle EWO3		

Dwayne Croley OAK3		Brantley Parrigan
334	Fall 0:18	
Brantley Parrigan		

WRESTLERS

- L. Kyer (LEO1)
- B. Parrigan ()
- G. Sentle (EWO3)
- D. Croley (OAK3)

L. Kyer (LEO1)
1ST

G. Sentle (EWO3)
2ND

B. Parrigan ()
3RD

D. Croley (OAK3)
4TH

Turkey Takedown-OACPts-Open/Novice

Division 2 Novice 72-77

3

Round 1

Teddy Mason OAK3		Tj Franks VBC3
Tj Franks VBC3	303	Maj 11-0

Ashlyn Schauptert EWO3		Nolan Hummel JFWC
Nolan Hummel JFWC	304	Fall 1:46

Round 2

Teddy Mason OAK3		Teddy Mason OAK3
Nolan Hummel JFWC	319	Fall 2:00

Ashlyn Schauptert EWO3		Tj Franks VBC3
Tj Franks VBC3	320	Maj 11-0

Round 3

Teddy Mason OAK3		Ashlyn Schauptert EWO3
Ashlyn Schauptert EWO3	335	Dec 6-0

Nolan Hummel JFWC		Tj Franks VBC3
Tj Franks VBC3	336	Fall 1:19

WRESTLERS

T. Mason (OAK3)

T. Franks (VBC3)

A. Schauptert (EWO3)

N. Hummel (JFWC)

T. Franks (VBC3)

1ST

T. Mason (OAK3)

2ND

N. Hummel (JFWC)

3RD

A. Schauptert (EWO3)

4TH

Turkey Takedown-OACPts-Open/Novice

Division 2 Novice 81-86

3

Round 1

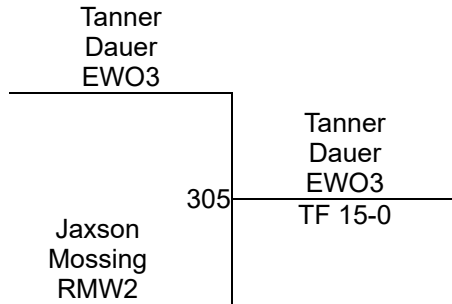

Round 2

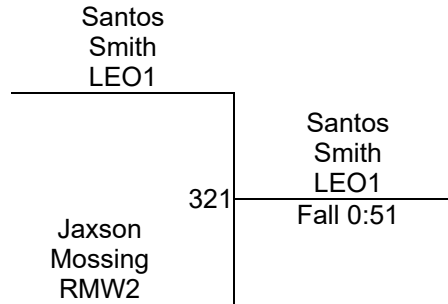

Round 3

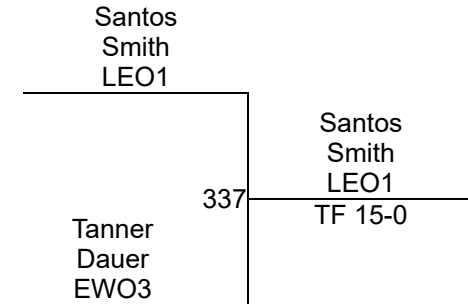

S. Smith (LEO1)

1ST

T. Dauer (EWO3)

2ND

J. Mossing (RMW2)

3RD

Turkey Takedown-OACPts-Open/Novice

Division 2 Novice 97-97 3

Round 1

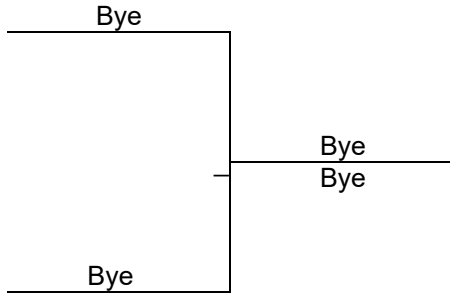

Round 2

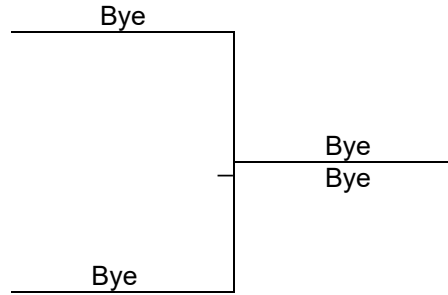

Round 3

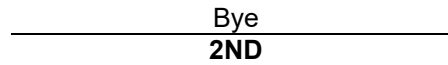
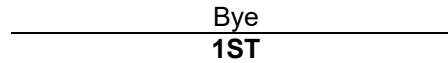
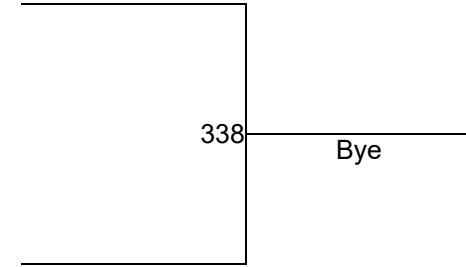

Turkey Takedown-OACPts-Open/Novice

Division 2 Novice 107-107

3

Round 1

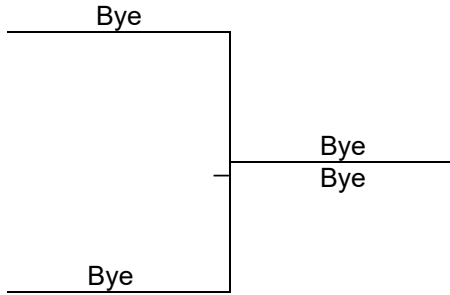

Round 2

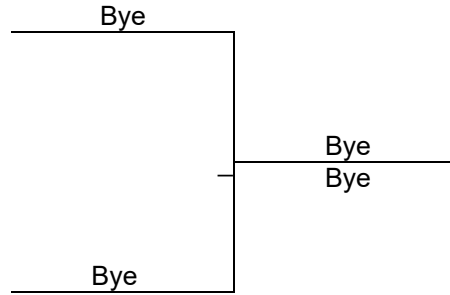

Round 3

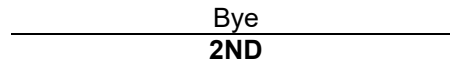
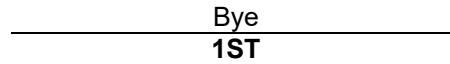
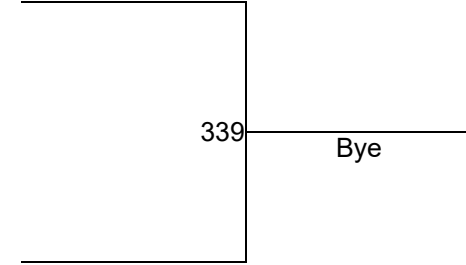

Turkey Takedown-OACPts-Open/Novice

Division 2 Novice 118-118

3

Round 1

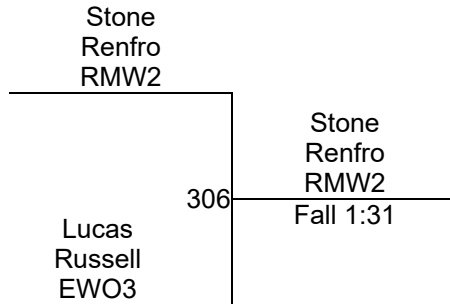

Round 2

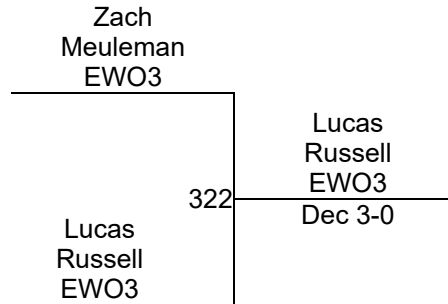

Round 3

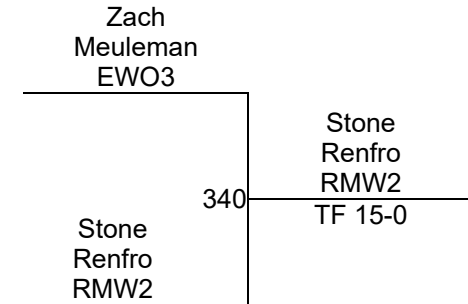

S. Renfro (RMW2)

1ST

L. Russell (EWO3)

2ND

Z. Meuleman (EWO3)

3RD

Turkey Takedown-OACPts-Open/Novice

Division 3 Novice 43-43 3

Round 1

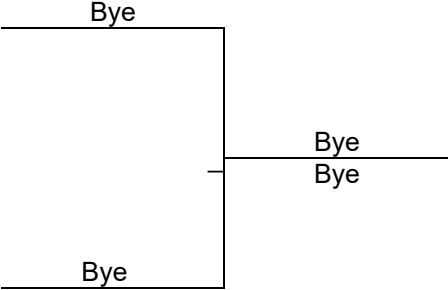

Round 2

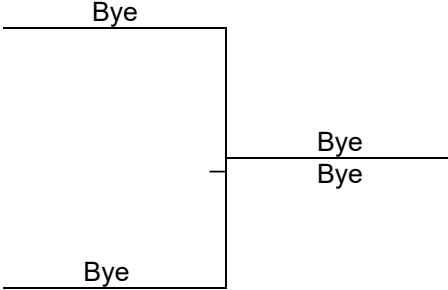

Round 3

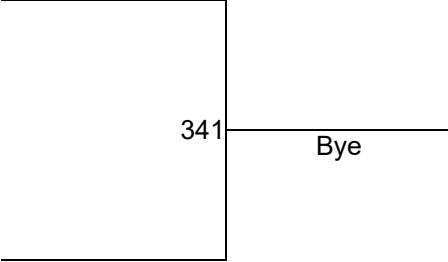

Bye
1ST

Bye
2ND

Turkey Takedown-OACPts-Open/Novice

Division 3 Novice 53-56

3

Round 1

Jesse Tovar EWO3		Tristen Householder BAY2
Tristen Householder BAY2	307	Fall 0:26

Maddox Fisher EWO3		Weston Wott FDMA
Weston Wott FDMA	308	Fall 1:12

Round 2

Jesse Tovar EWO3		Weston Wott FDMA
Weston Wott FDMA	323	Fall 0:24

Maddox Fisher EWO3		Tristen Householder BAY2
Tristen Householder BAY2	324	Fall 0:30

Round 3

Jesse Tovar EWO3		Maddox Fisher EWO3
Maddox Fisher EWO3	342	Fall 0:51

Weston Wott FDMA		Weston Wott FDMA
Tristen Householder BAY2	343	Fall 2:16

WRESTLERS

J. Tovar (EWO3)

T. Householder (BAY2)

M. Fisher (EWO3)

W. Wott (FDMA)

W. Wott (FDMA)

1ST

T. Householder (BAY2)

2ND

M. Fisher (EWO3)

3RD

J. Tovar (EWO3)

4TH

Turkey Takedown-OACPts-Open/Novice

Division 3 Novice 58-61

3

Round 1

Callum Jordan BAY2		Xander Maas RMW2	
-----		-----	
Xander Maas RMW2	309	Fall 0:29	

Hoyt Halbisen RMW2		Hoyt Halbisen RMW2	
-----		-----	
Alissa Coutcher LEO1	310	Dec 12-10	

Round 2

Callum Jordan BAY2		Callum Jordan BAY2	
-----		-----	
Alissa Coutcher LEO1	325	TF 18-3	

Hoyt Halbisen RMW2		Xander Maas RMW2	
-----		-----	
Xander Maas RMW2	326	TF 15-0	

Round 3

Callum Jordan BAY2		Callum Jordan BAY2	
-----		-----	
Hoyt Halbisen RMW2	344	TF 17-2	

Alissa Coutcher LEO1		Xander Maas RMW2	
-----		-----	
Xander Maas RMW2	345	Fall 0:28	

WRESTLERS

- C. Jordan (BAY2)
- X. Maas (RMW2)
- H. Halbisen (RMW2)
- A. Coutcher (LEO1)

X. Maas (RMW2)

1ST

C. Jordan (BAY2)

2ND

H. Halbisen (RMW2)

3RD

A. Coutcher (LEO1)

4TH

Turkey Takedown-OACPts-Open/Novice

Division 3 Novice 61-65

3

Round 1

Carson Sybert JRP1		Caiden Strunk RMW2	
Caiden Strunk RMW2	311	Fall 1:40	

Brantley Brasel EWO3		Travis Shoemaker BTWA	
Travis Shoemaker BTWA	312	Fall 1:59	

Round 2

Carson Sybert JRP1		Travis Shoemaker BTWA	
Travis Shoemaker BTWA	327	Fall 0:43	

Brantley Brasel EWO3		Caiden Strunk RMW2	
Caiden Strunk RMW2	328	Dec 6-3	

Round 3

Carson Sybert JRP1		Brantley Brasel EWO3	
Brantley Brasel EWO3	346	Fall 0:44	

Travis Shoemaker BTWA		Travis Shoemaker BTWA	
Caiden Strunk RMW2	347	Fall 0:53	

WRESTLERS

- C. Sybert (JRP1)
- C. Strunk (RMW2)
- B. Brasel (EWO3)
- T. Shoemaker (BTWA)

T. Shoemaker (BTWA)
1ST

C. Strunk (RMW2)
2ND

B. Brasel (EWO3)
3RD

C. Sybert (JRP1)
4TH

Turkey Takedown-OACPts-Open/Novice

Division 3 Novice 62-65

3

Round 1

Dominic Randazzo BAY2		Troy Pierce EWO3
	313	Fall 2:30
Troy Pierce EWO3		

Calahan Dennings RMW2		Calahan Dennings RMW2
	314	Fall 2:37
Averieanna Wiechman RMW2		

Round 2

Dominic Randazzo BAY2		Dominic Randazzo BAY2
	329	Fall 0:27
Averieanna Wiechman RMW2		

Calahan Dennings RMW2		Troy Pierce EWO3
	330	Maj 18-8
Troy Pierce EWO3		

Round 3

Dominic Randazzo BAY2		Dominic Randazzo BAY2
	348	Fall 1:28
Calahan Dennings RMW2		

Averieanna Wiechman RMW2		Troy Pierce EWO3
	349	Fall 0:38
Troy Pierce EWO3		

WRESTLERS

D. Randazzo (BAY2)

T. Pierce (EWO3)

C. Dennings (RMW2)

A. Wiechman (RMW2)

T. Pierce (EWO3)

1ST

D. Randazzo (BAY2)

2ND

C. Dennings (RMW2)

3RD

A. Wiechman (RMW2)

4TH

Turkey Takedown-OACPts-Open/Novice

Division 3 Novice 66-69

3

Round 1

Jett Gradel OAK3		Jett Gradel OAK3	
Markus Molina EWO3	315	Maj 8-0	

Carmen Monroe EWO3		Carmen Monroe EWO3	
Ben Mayo BAY2	316	Fall 1:41	

Round 2

Jett Gradel OAK3		Jett Gradel OAK3	
Ben Mayo BAY2	331	Fall 1:28	

Carmen Monroe EWO3		Carmen Monroe EWO3	
Markus Molina EWO3	332	Fall 2:48	

Round 3

Jett Gradel OAK3		Carmen Monroe EWO3	
Carmen Monroe EWO3	350	Fall 2:23	

Ben Mayo BAY2		Ben Mayo BAY2	
Markus Molina EWO3	351	Dec 9-8	

WRESTLERS

J. Gradel (OAK3)

M. Molina (EWO3)

C. Monroe (EWO3)

B. Mayo (BAY2)

C. Monroe (EWO3)

1ST

J. Gradel (OAK3)

2ND

B. Mayo (BAY2)

3RD

M. Molina (EWO3)

4TH

Turkey Takedown-OACPts-Open/Novice

Division 3 Novice 73-75 4

Round 1

Cael Achter LEO1		Cael Achter LEO1
Bentley Richards EWO3	401	Dec 10-5

Logan Simpson EWO3		Colton Moore OAK3
Colton Moore OAK3	402	TF 17-1

C. Achter (LEO1)
1ST

Round 2

Walker Finn OAK3		Walker Finn OAK3
Colton Moore OAK3	417	Fall 2:35

Cael Achter LEO1		Cael Achter LEO1
Logan Simpson EWO3	418	Maj 9-0

W. Finn (OAK3)
2ND

Round 3

Walker Finn OAK3		Walker Finn OAK3
Logan Simpson EWO3	433	TF 15-0

Bentley Richards EWO3		Bentley Richards EWO3
Colton Moore OAK3	434	Dec 6-3

B. Richards (EWO3)
3RD

Round 4

Walker Finn OAK3		Walker Finn OAK3
Bentley Richards EWO3	452	Fall 1:59

Cael Achter LEO1		Cael Achter LEO1
Colton Moore OAK3	453	TF 15-0

C. Moore (OAK3)
4TH

Round 5

Walker Finn OAK3		Cael Achter LEO1
Cael Achter LEO1	454	Dec 8-7

Bentley Richards EWO3		Bentley Richards EWO3
Logan Simpson EWO3	455	Dec 6-3

L. Simpson (EWO3)
5TH

Turkey Takedown-OACPts-Open/Novice

Division 3 Novice 80-83

4

Round 1

Ashton Prophet JRP1		Owen Rochowiak RMW2
Owen Rochowiak RMW2	403	Dec 11-4

Chad Stahl Junior Flyer Wr		Chad Stahl Junior Flyer Wr
Major Foster VBC3	404	Fall 0:38

Round 2

Ashton Prophet JRP1		Major Foster VBC3
Major Foster VBC3	419	Fall 1:58

Chad Stahl Junior Flyer Wr		Owen Rochowiak RMW2
Owen Rochowiak RMW2	420	Fall 0:32

Round 3

Ashton Prophet JRP1		Chad Stahl Junior Flyer Wr
Chad Stahl Junior Flyer Wr	435	Fall 1:50

Major Foster VBC3		Major Foster VBC3
Owen Rochowiak RMW2	436	Dec 9-7

WRESTLERS

A. Prophet (JRP1)

O. Rochowiak (RMW2)

C. Stahl (Junior Flyer Wrestling CI)

M. Foster (VBC3)

C. Stahl (Junior Flyer Wrestling CI)

1ST

M. Foster (VBC3)

2ND

O. Rochowiak (RMW2)

3RD

A. Prophet (JRP1)

4TH

Turkey Takedown-OACPts-Open/Novice

Division 3 Novice 84-85

4

Round 1

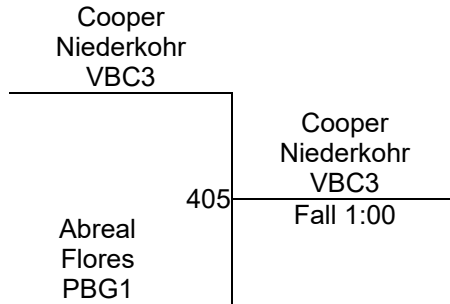

Round 2

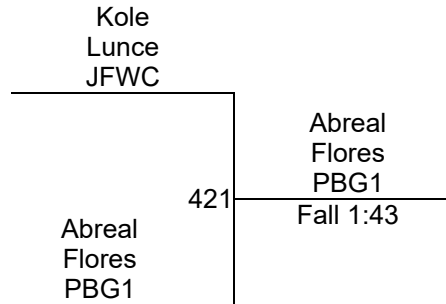

Round 3

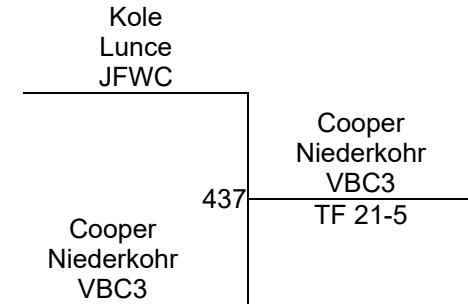

C. Niederkoehr (VBC3)

1ST

A. Flores (PBG1)

2ND

K. Lunce (JFWC)

3RD

Turkey Takedown-OACPts-Open/Novice

Division 3 Novice 86-86

4

Round 1

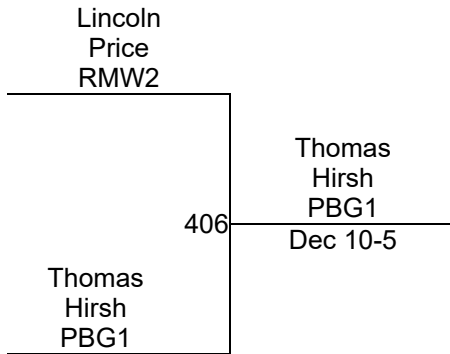

Round 2

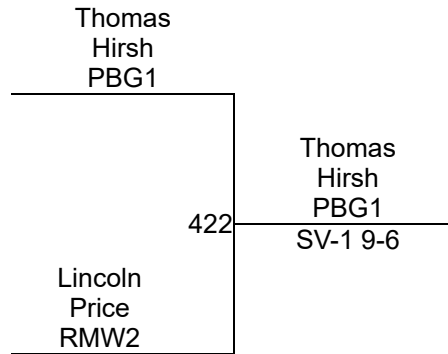

Round 3

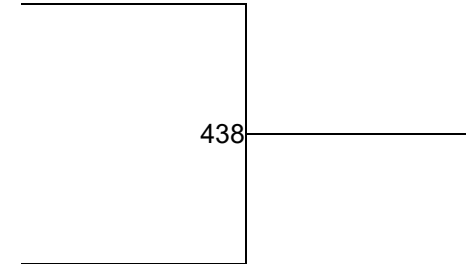

T. Hirsh (PBG1)
1ST

L. Price (RMW2)
2ND

Turkey Takedown-OACPts-Open/Novice

Division 3 Novice 89-96

4

Round 1

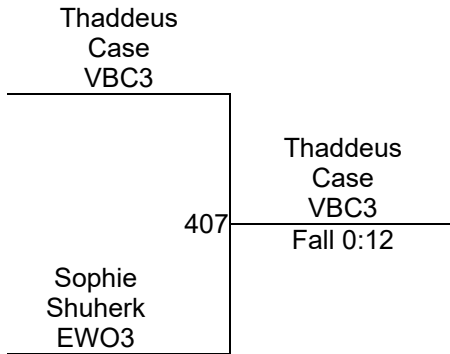

Round 2

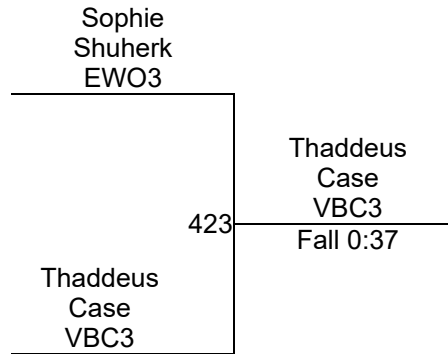

Round 3

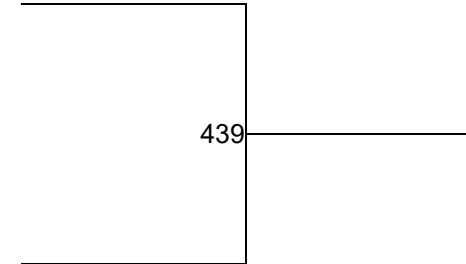

T. Case (VBC3)
1ST

S. Shuherk (EWO3)
2ND

Turkey Takedown-OACPts-Open/Novice

Division 3 Novice 111-111 4

Round 1

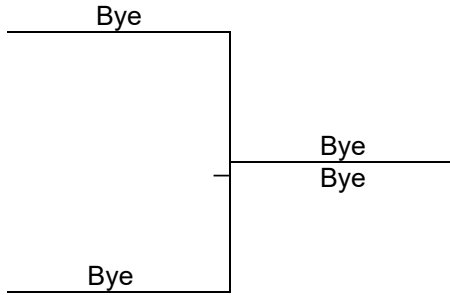

Round 2

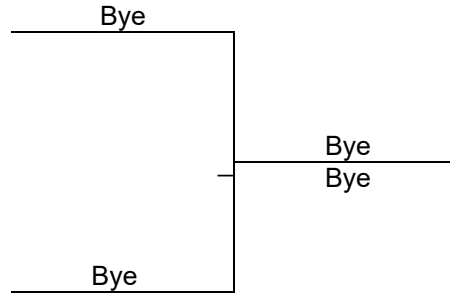

Round 3

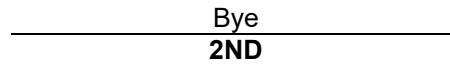
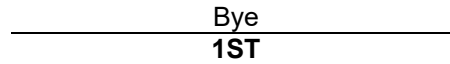
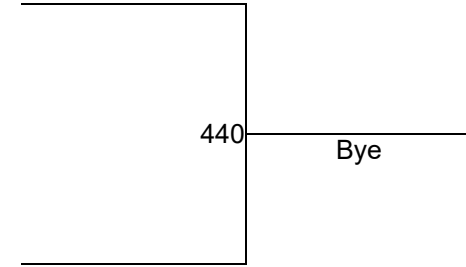

Turkey Takedown-OACPts-Open/Novice

Division 3 Novice 150-153

4

Round 1

Easton Hummel JFWC			
	408	Easton Hummel JFWC	
Zachary Marble PBG1		Fall 0:31	

Round 2

Jackson Arthur			
	424	Jackson Arthur	
Zachary Marble PBG1		Fall 0:31	

Round 3

Jackson Arthur			
	441	Easton Hummel JFWC	
Easton Hummel JFWC		Fall 2:32	

E. Hummel (JFWC)
1ST

J. Arthur ()
2ND

Z. Marble (PBG1)
3RD

Turkey Takedown-OACPts-Open/Novice

Division 4 Novice 68-71

4

Round 1

Forrest Shoemaker BTWA		Forrest Shoemaker BTWA
Jaxon Toral EMPA	409	Fall 0:32

Major McAllister EMPA		Major McAllister EMPA
Michael Arnold SHB1	410	Fall 0:12

Round 2

Forrest Shoemaker BTWA		Forrest Shoemaker BTWA
Michael Arnold SHB1	425	Fall 0:10

Major McAllister EMPA		Major McAllister EMPA
Jaxon Toral EMPA	426	Fall 1:45

Round 3

Forrest Shoemaker BTWA		Forrest Shoemaker BTWA
Major McAllister EMPA	442	Fall 0:41

Michael Arnold SHB1		Jaxon Toral EMPA
Jaxon Toral EMPA	443	Fall 0:23

WRESTLERS

F. Shoemaker (BTWA)

J. Toral (EMPA)

M. McAllister (EMPA)

M. Arnold (SHB1)

F. Shoemaker (BTWA)

1ST

M. McAllister (EMPA)

2ND

J. Toral (EMPA)

3RD

M. Arnold (SHB1)

4TH

Turkey Takedown-OACPts-Open/Novice

Division 4 Novice 73-75

4

Round 1

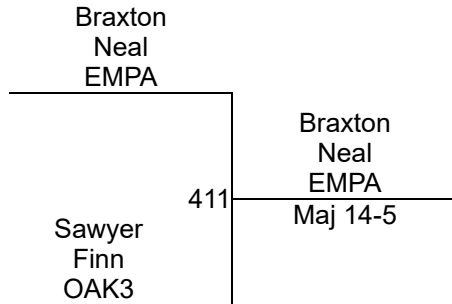

Round 2

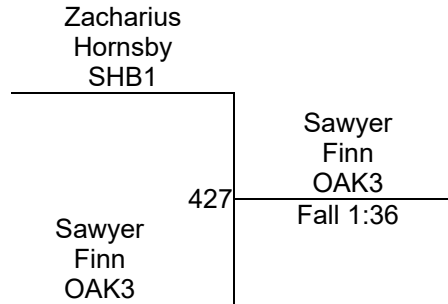

Round 3

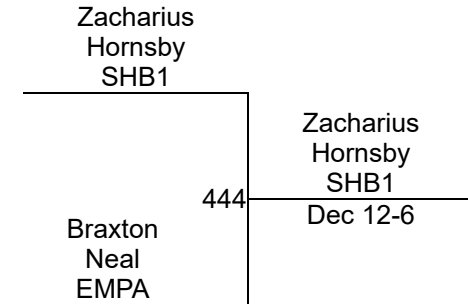

S. Finn (OAK3)

1ST

B. Neal (EMPA)

2ND

Z. Hornsby (SHB1)

3RD

Turkey Takedown-OACPts-Open/Novice

Division 4 Novice 75-82

4

Round 1

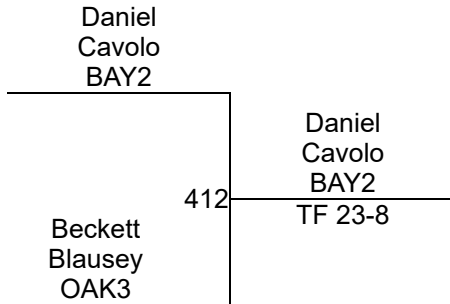

Round 2

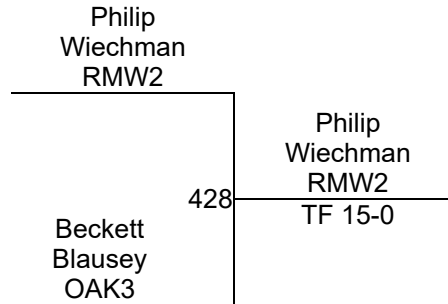

Round 3

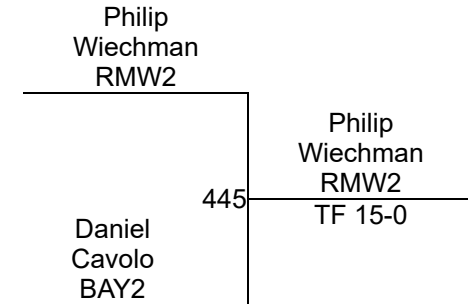

P. Wiechman (RMW2)
1ST

D. Cavolo (BAY2)
2ND

B. Blausey (OAK3)
3RD

Turkey Takedown-OACPts-Open/Novice

Division 4 Novice 85-92

4

Round 1

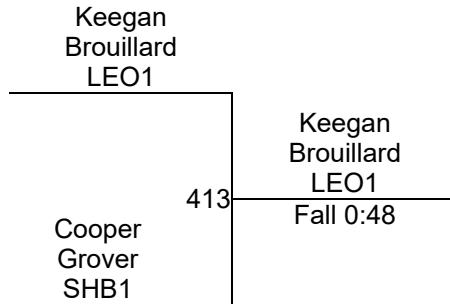

Round 2

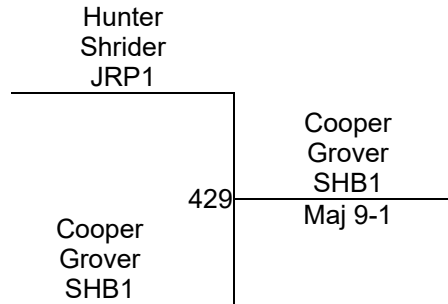

Round 3

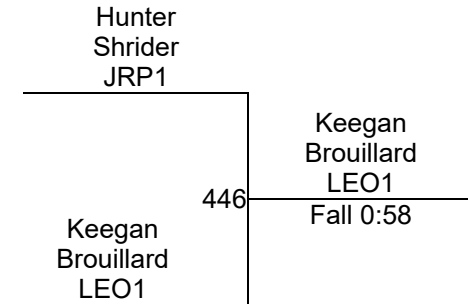

K. Brouillard (LEO1)

1ST

C. Grover (SHB1)

2ND

H. Shrider (JRP1)

3RD

Turkey Takedown-OACPts-Open/Novice

Division 4 Novice 90-94 4

Round 1

Conner Glenn SHB1		Wilson Hirsh PBG1
	414	Fall 0:31
Wilson Hirsh PBG1		

Round 2

Laif Achter OCW1		Laif Achter OCW1
	430	Dec 9-3
Wilson Hirsh PBG1		

Round 3

Laif Achter OCW1		Laif Achter OCW1
	447	Fall 0:47
Conner Glenn SHB1		

L. Achter (OCW1)

1ST

W. Hirsh (PBG1)

2ND

C. Glenn (SHB1)

3RD

Turkey Takedown-OACPts-Open/Novice

Division 4 Novice 106-109

4

Round 1

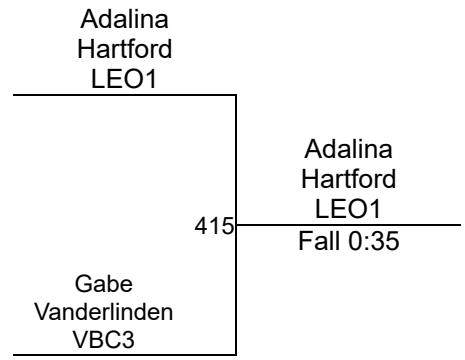

Round 2

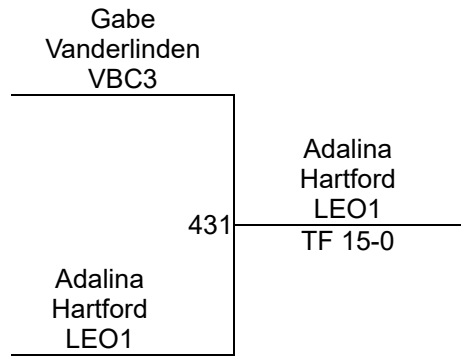

Round 3

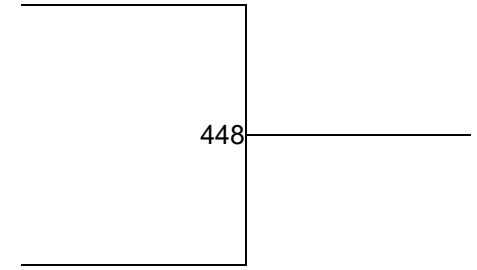

A. Hartford (LEO1)
1ST

G. Vanderlinden (VBC3)
2ND

Turkey Takedown-OACPts-Open/Novice

Division 4 Novice 123-135

4

Round 1

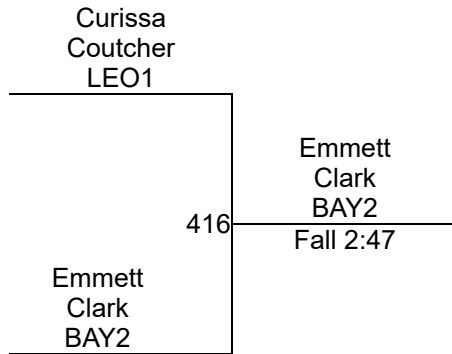

Round 2

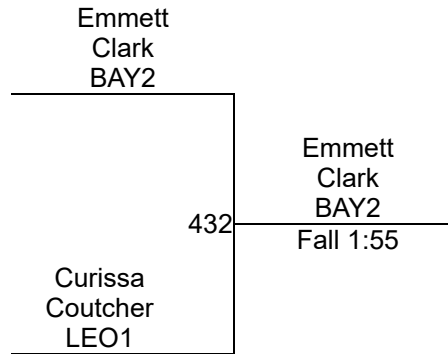

Round 3

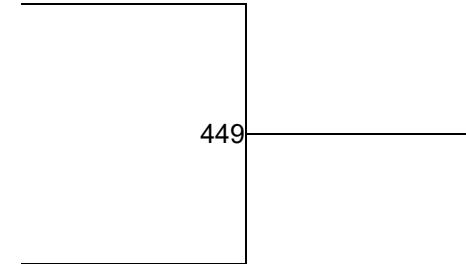

E. Clark (BAY2)
1ST

C. Coutcher (LEO1)
2ND

Turkey Takedown-OACPts-Open/Novice

Division 4 Novice 139-139

4

Round 1

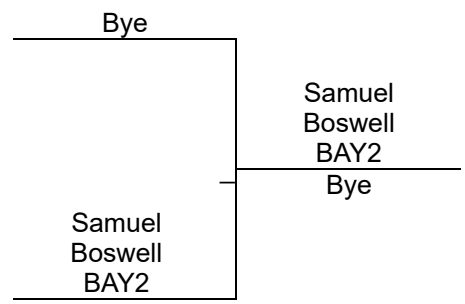

Round 2

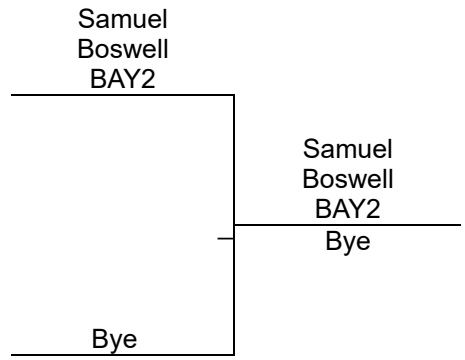

Round 3

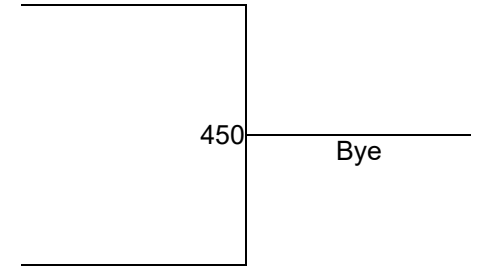

S. Boswell (BAY2)
1ST

Bye
2ND

Turkey Takedown-OACPts-Open/Novice

Division 4 Novice 183-183

4

Round 1

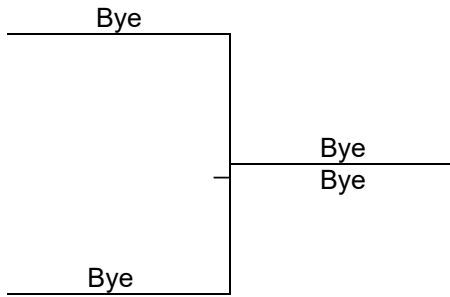

Round 2

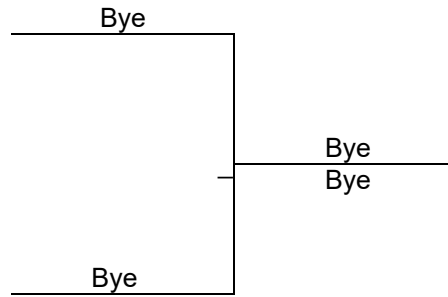

Round 3

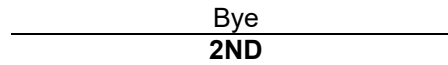
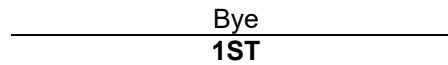
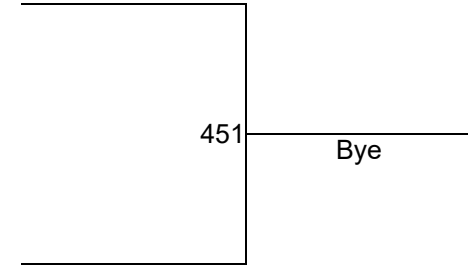

Turkey Takedown-OACPts-Open/Novice

Division 2 Open 45-50
Mat 1 PM

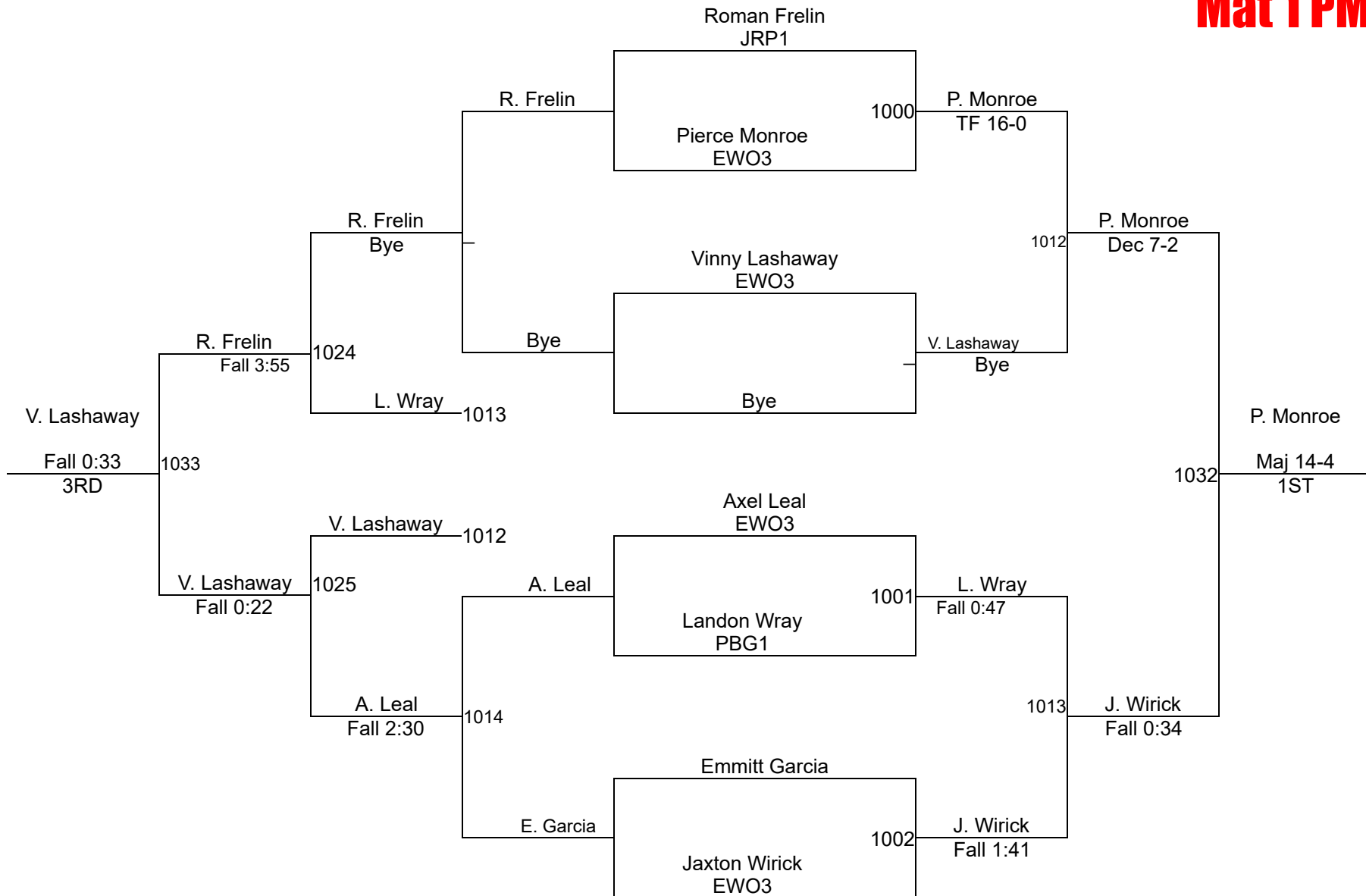

Turkey Takedown-OACPts-Open/Novice

Division 2 Open 51-57
Mat 1 PM

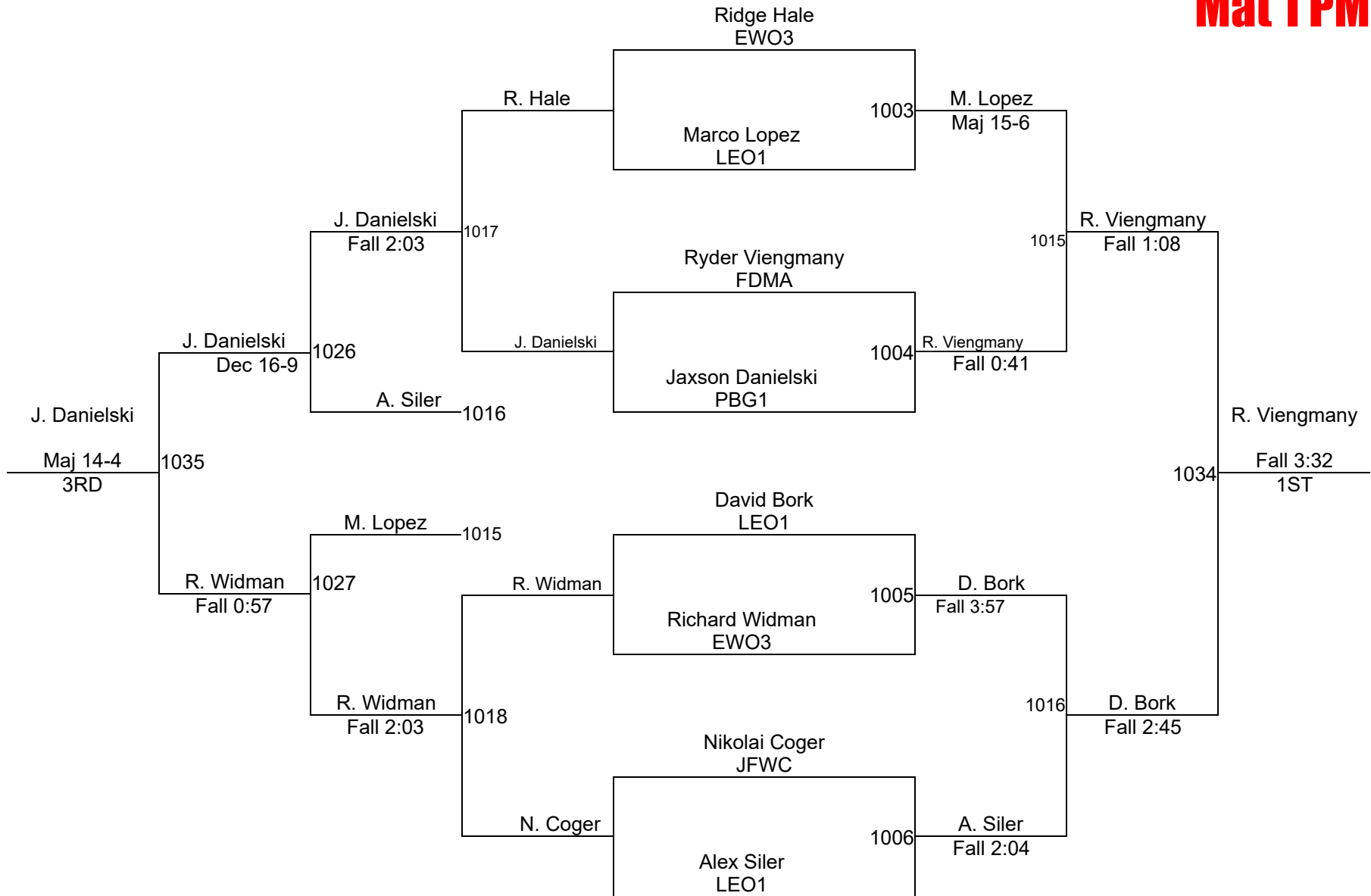

Turkey Takedown-OACPts-Open/Novice

Division 2 Open 61-66
Mat 1 PM

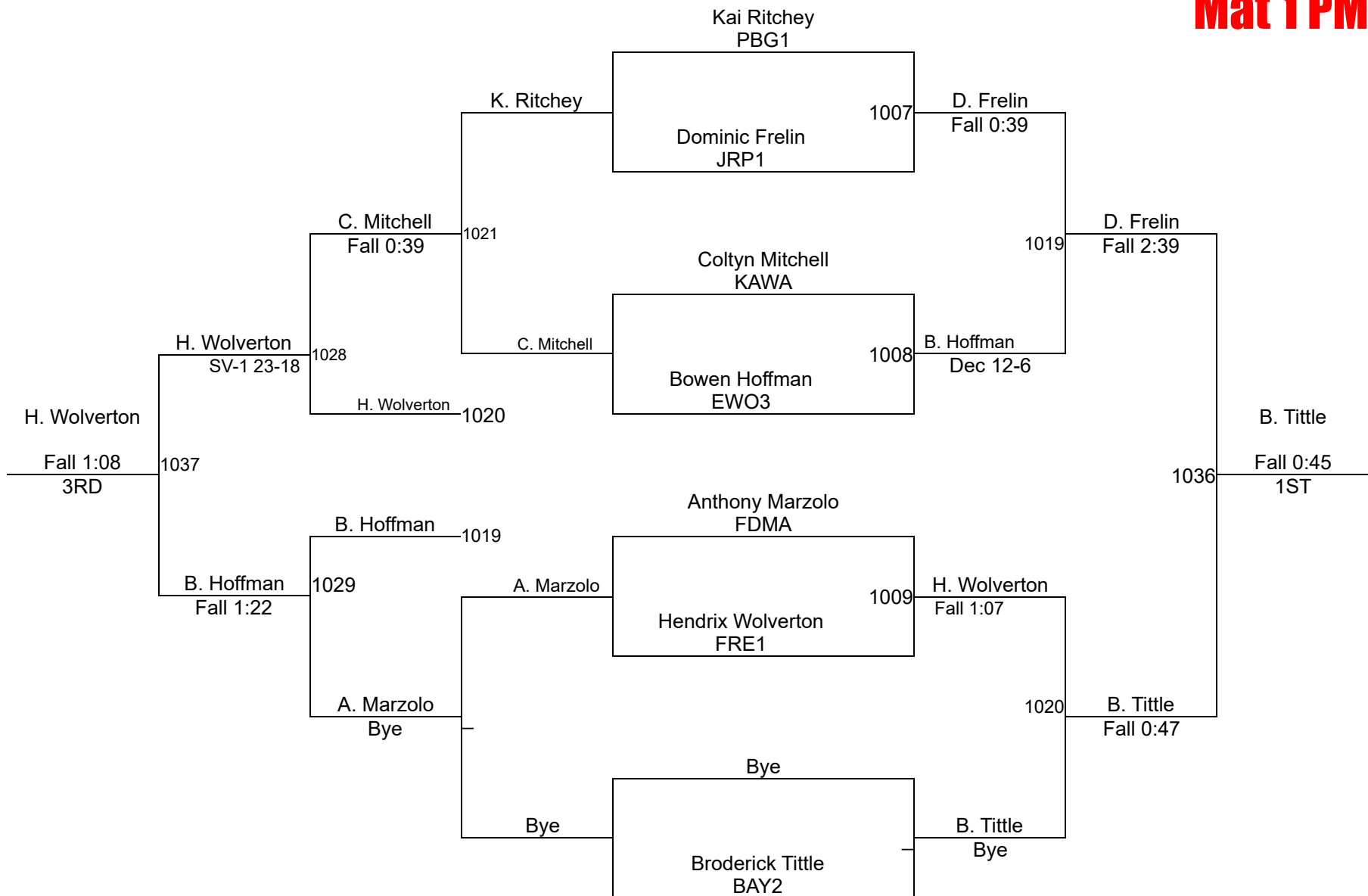

Turkey Takedown-OACPts-Open/Novice

Division 2 Open 69-73 Mat 1 PM

Round 1

Jace Korb SHB1		Jace Korb SHB1	
Beau Coleman PBG1	1010	Fall 2:40	

Roman Moody EWO3		Roman Moody EWO3	
Leopoldo Zenowicz RMW2	1011	Fall 0:58	

J. Korb (SHB1)
1ST

Round 2

Ryan Gahler OAK3		Ryan Gahler OAK3	
Leopoldo Zenowicz RMW2	1022	Fall 1:01	

Jace Korb SHB1		Jace Korb SHB1	
Roman Moody EWO3	1023	Fall 2:16	

B. Coleman (PBG1)
2ND

Round 3

Ryan Gahler OAK3		Roman Moody EWO3	
Roman Moody EWO3	1030	Fall 0:42	

Beau Coleman PBG1		Beau Coleman PBG1	
Leopoldo Zenowicz RMW2	1031	Fall 1:05	

R. Moody (EWO3)
3RD

Round 4

Ryan Gahler OAK3		Beau Coleman PBG1	
Beau Coleman PBG1	1038	Fall 2:45	

Jace Korb SHB1		Jace Korb SHB1	
Leopoldo Zenowicz RMW2	1039	TF 18-3	

R. Gahler (OAK3)
4TH

Round 5

Ryan Gahler OAK3		Jace Korb SHB1	
Jace Korb SHB1	1040	Fall 1:18	

Beau Coleman PBG1		Beau Coleman PBG1	
Roman Moody EWO3	1041	Fall 2:10	

L. Zenowicz (RMW2)
5TH

Turkey Takedown-OACPts-Open/Novice

Division 2 Open 81-99 Mat 2 PM

Round 1

Zane Hoover LEO1		Zane Hoover LEO1
Konnor Schmidlin SHB1	2000	Fall 0:31

Chad Stahl Jr Junior Flyer Wr		Chad Stahl Jr Junior Flyer Wr
Tanner Dauer EWO3	2001	Fall 2:19

Round 2

Zane Hoover LEO1		Zane Hoover LEO1
Tanner Dauer EWO3	2011	TF 15-0

Chad Stahl Jr Junior Flyer Wr		Chad Stahl Jr Junior Flyer Wr
Konnor Schmidlin SHB1	2012	TF 16-1

Round 3

Zane Hoover LEO1		Zane Hoover LEO1
Chad Stahl Jr Junior Flyer Wr	2022	Fall 2:05

Tanner Dauer EWO3		Tanner Dauer EWO3
Konnor Schmidlin SHB1	2023	Fall 1:06

WRESTLERS

Z. Hoover (LEO1)

K. Schmidlin (SHB1)

C. Stahl Jr (Junior Flyer Wrestling Cl)

T. Dauer (EWO3)

Z. Hoover (LEO1)

1ST

C. Stahl Jr (Junior Flyer Wrestling Cl)

2ND

T. Dauer (EWO3)

3RD

K. Schmidlin (SHB1)

4TH

Turkey Takedown-OACPts-Open/Novice

Divison 3 Open 53-57 Mat 2 PM

Round 1

Jesse Tovar EWO3	Amin Salem WSW1
Amin Salem WSW1 2002	Fall 0:13

Amare Muhammad LEO1	Amare Muhammad LEO1
Tristen Householder BAY2 2003	MFF

A. Muhammad (LEO1)
1ST

Round 2

Weston Wott FDMA	Weston Wott FDMA
Tristen Householder BAY2 2013	MFF

Jesse Tovar EWO3	Amare Muhammad LEO1
Amare Muhammad LEO1 2014	Fall 0:11

A. Salem (WSW1)
2ND

Round 3

Weston Wott FDMA	Amare Muhammad LEO1
Amare Muhammad LEO1 2024	Maj 9-1

Amin Salem WSW1	Amin Salem WSW1
Tristen Householder BAY2 2025	MFF

W. Wott (FDMA)
3RD

Round 4

Weston Wott FDMA	Amin Salem WSW1
Amin Salem WSW1 2032	Fall 2:53

Jesse Tovar EWO3	Jesse Tovar EWO3
Tristen Householder BAY2 2033	MFF

J. Tovar (EWO3)
4TH

Round 5

Weston Wott FDMA	Weston Wott FDMA
Jesse Tovar EWO3 2040	Fall 0:23

Amin Salem WSW1	Amare Muhammad LEO1
Amare Muhammad LEO1 2041	TF 25-10

T. Householder (BAY2)
5TH

Turkey Takedown-OACPts-Open/Novice

Divison 3 Open 58-64
Mat 2 PM

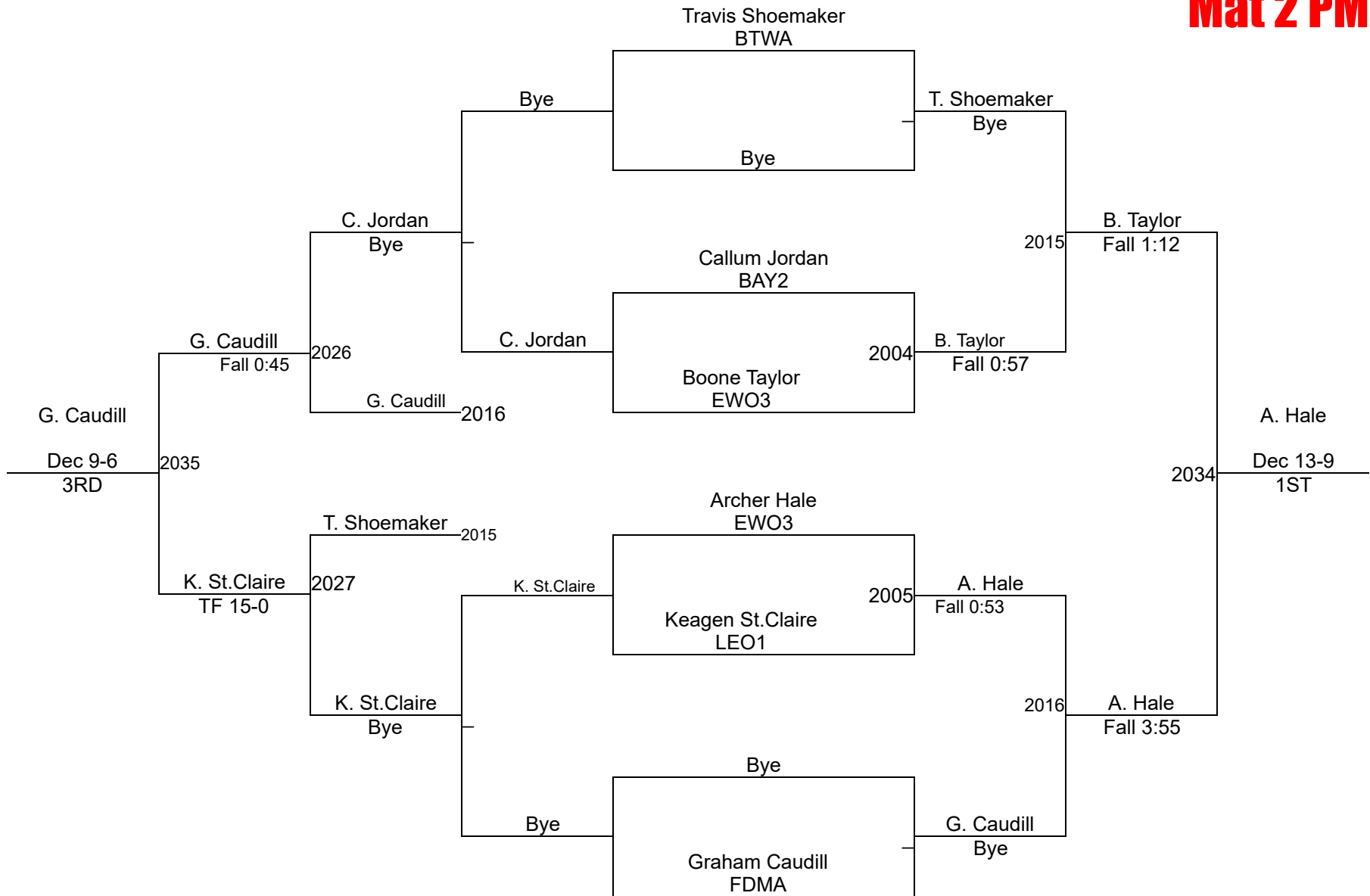

Turkey Takedown-OACPts-Open/Novice

Divison 3 Open 65-69
Mat 2 PM

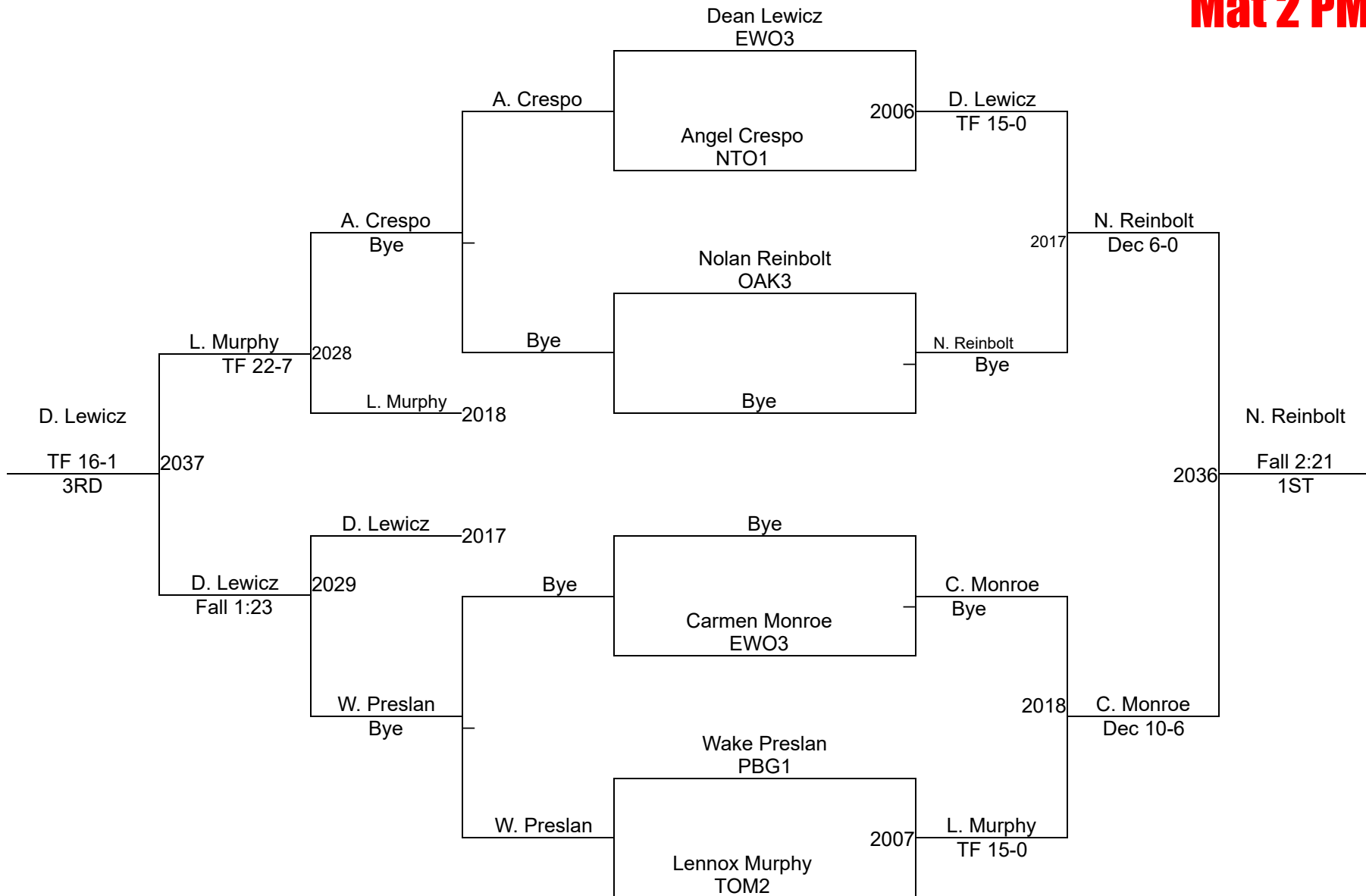

Turkey Takedown-OACPts-Open/Novice

Divison 3 Open 71-74
Mat 2 PM

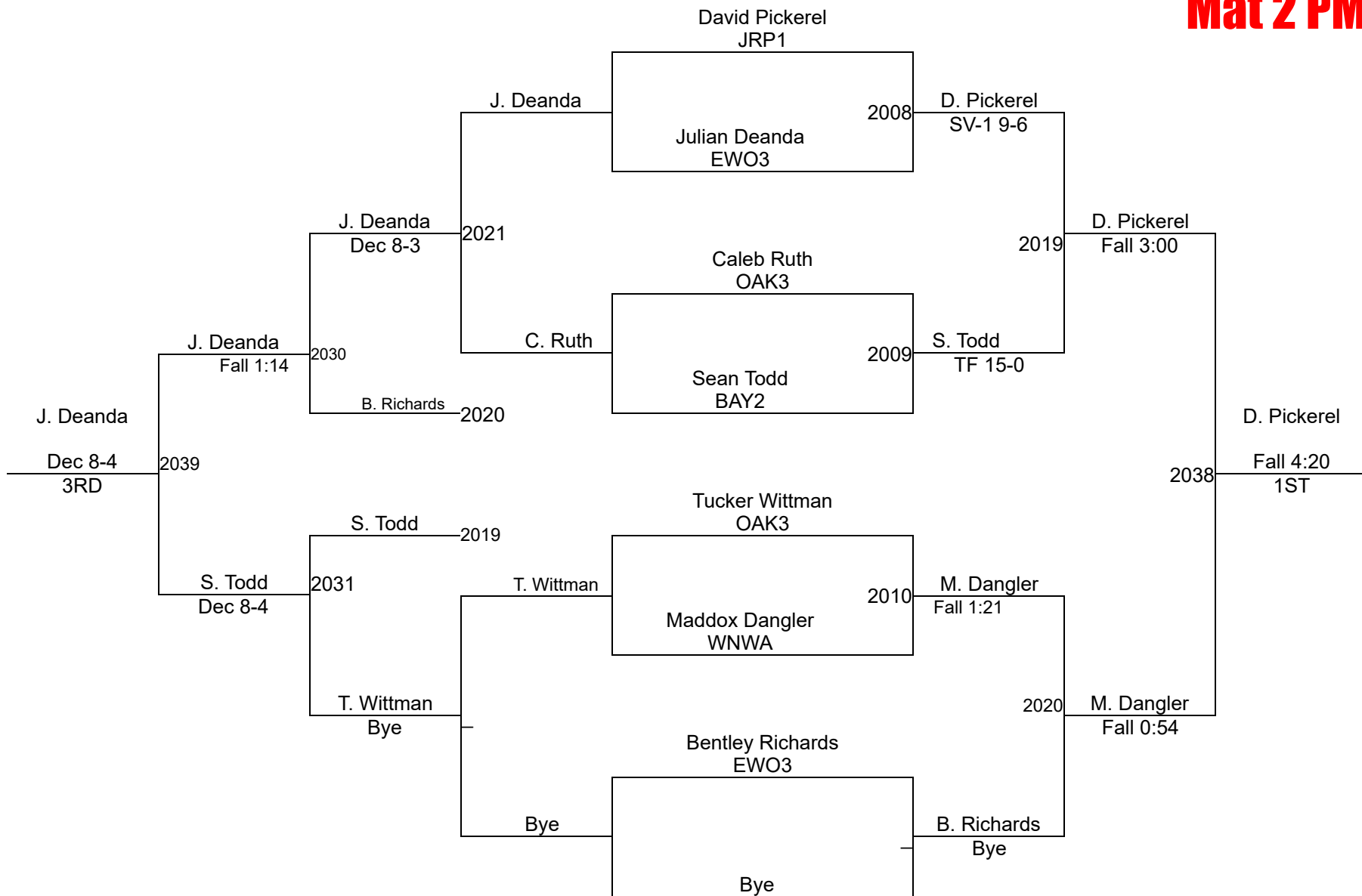

Turkey Takedown-OACPts-Open/Novice

Divison 3 Open 75-81
Mat 3 PM

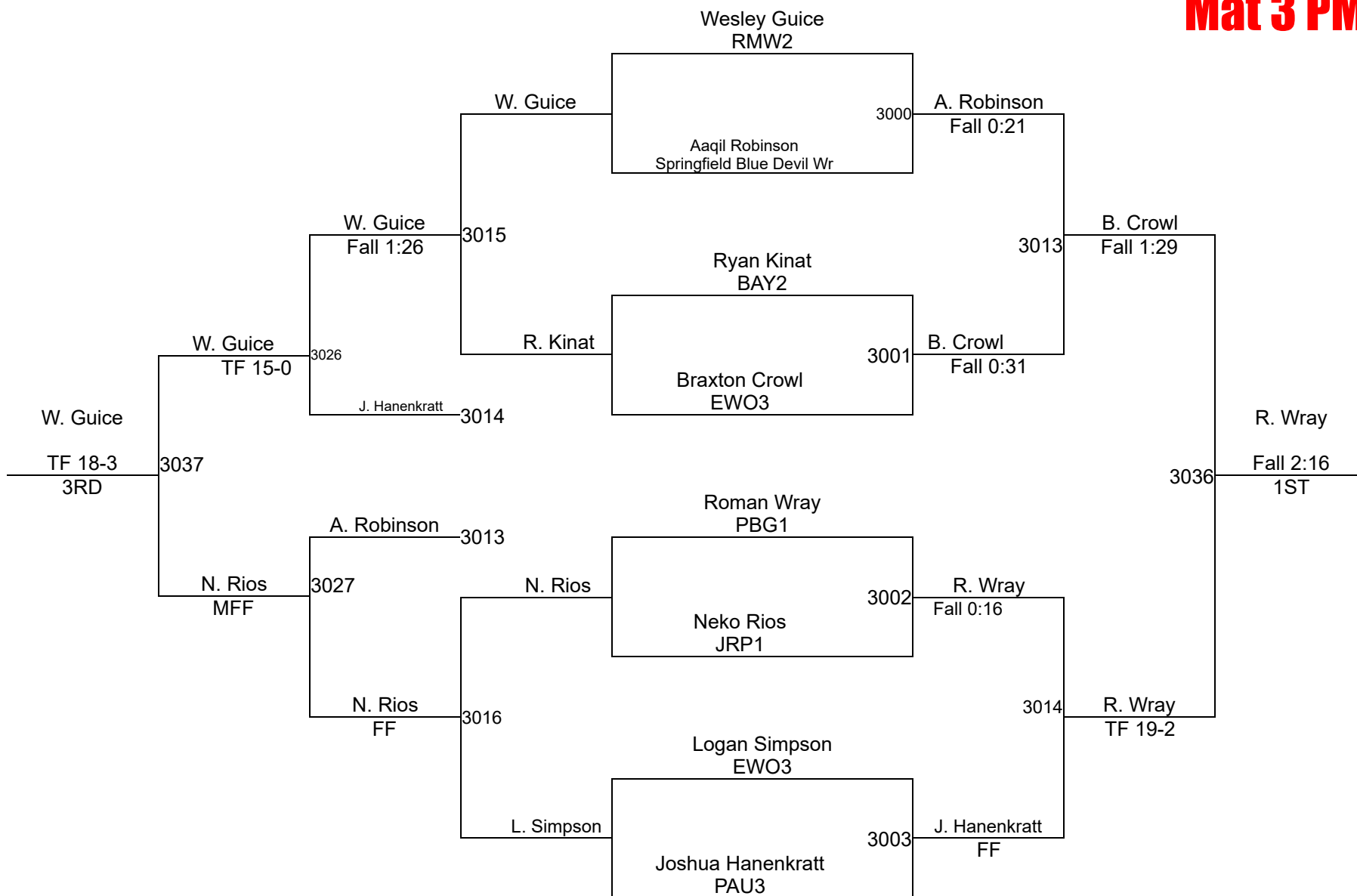

Turkey Takedown-OACPts-Open/Novice

Divison 3 Open 81-96
Mat 3 PM

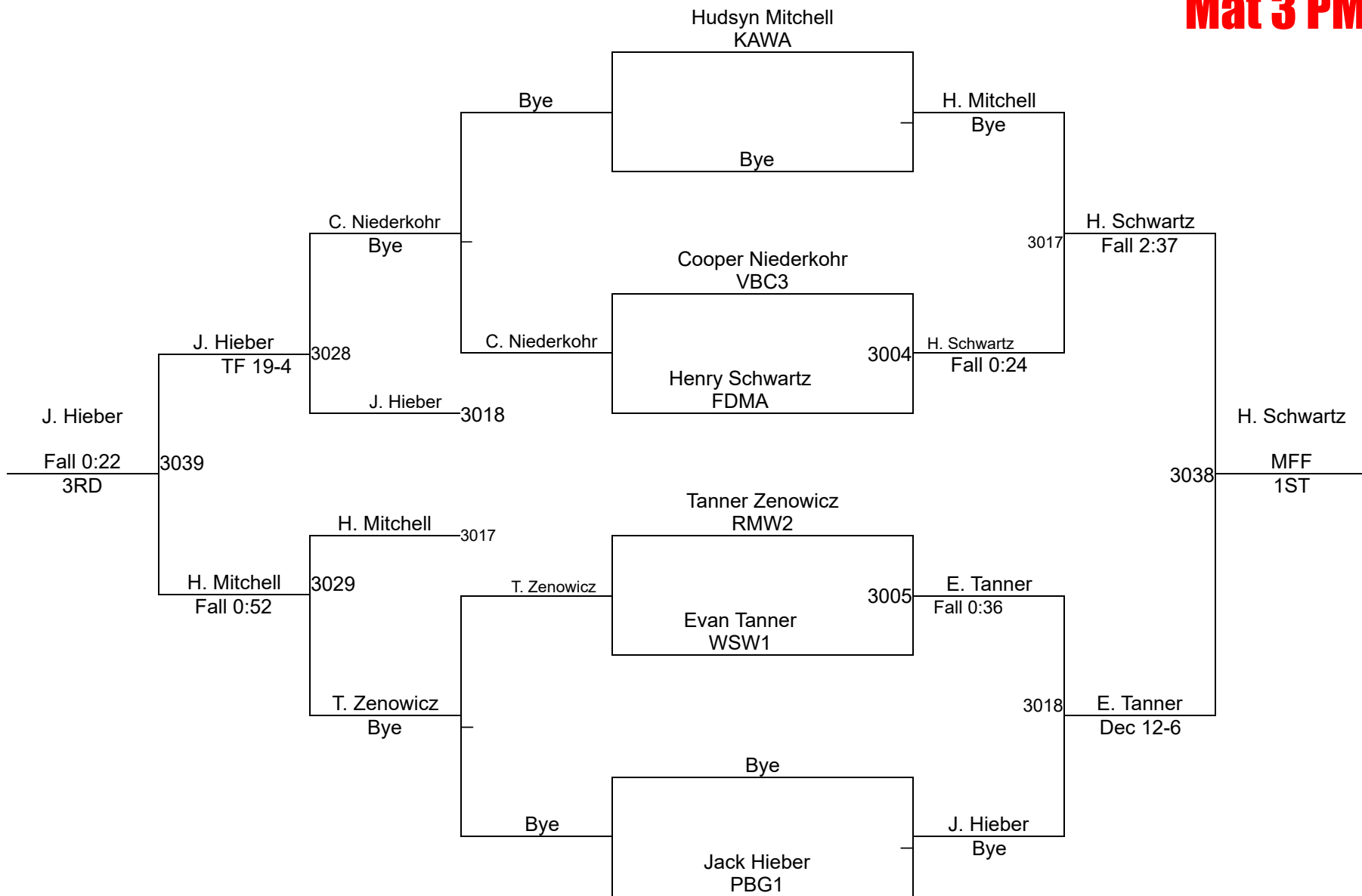

Turkey Takedown-OACPts-Open/Novice

Divison 3 Open 101-119 Mat 3 PM

Round 1

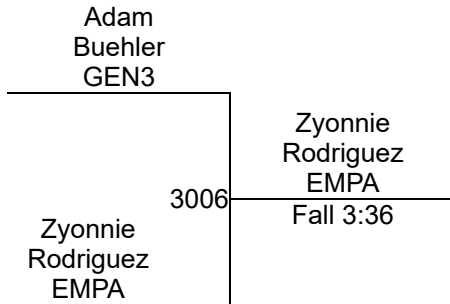

Round 2

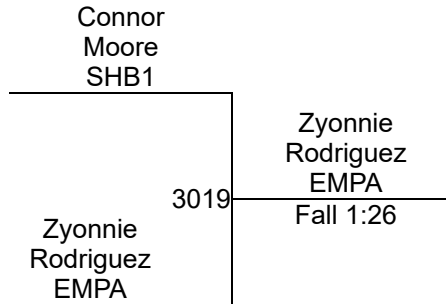

Round 3

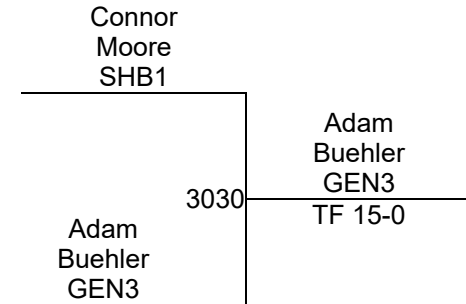

Z. Rodriguez (EMPA)
1ST

A. Buehler (GEN3)
2ND

C. Moore (SHB1)
3RD

Turkey Takedown-OACPts-Open/Novice

Divison 3 Open 139-145

Mat 3 PM

Round 1

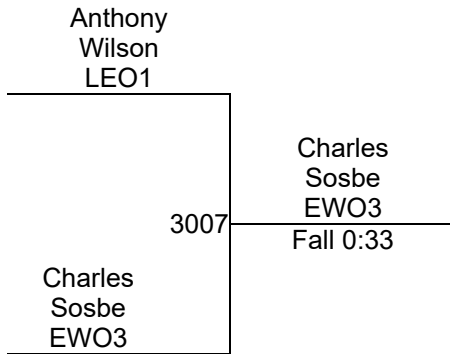

Round 2

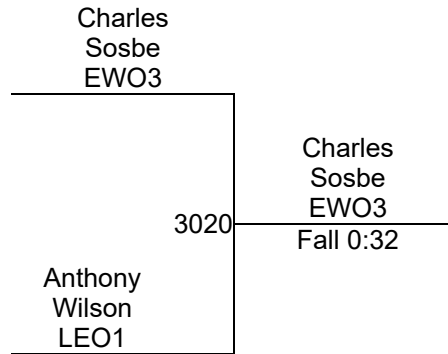

Round 3

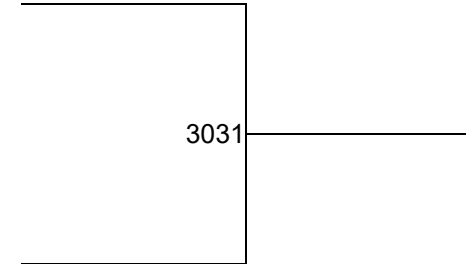

C. Sosbe (EWO3)
1ST

A. Wilson (LEO1)
2ND

Turkey Takedown-OACPts-Open/Novice

Divison 4 Open 66-71
Mat 3 PM

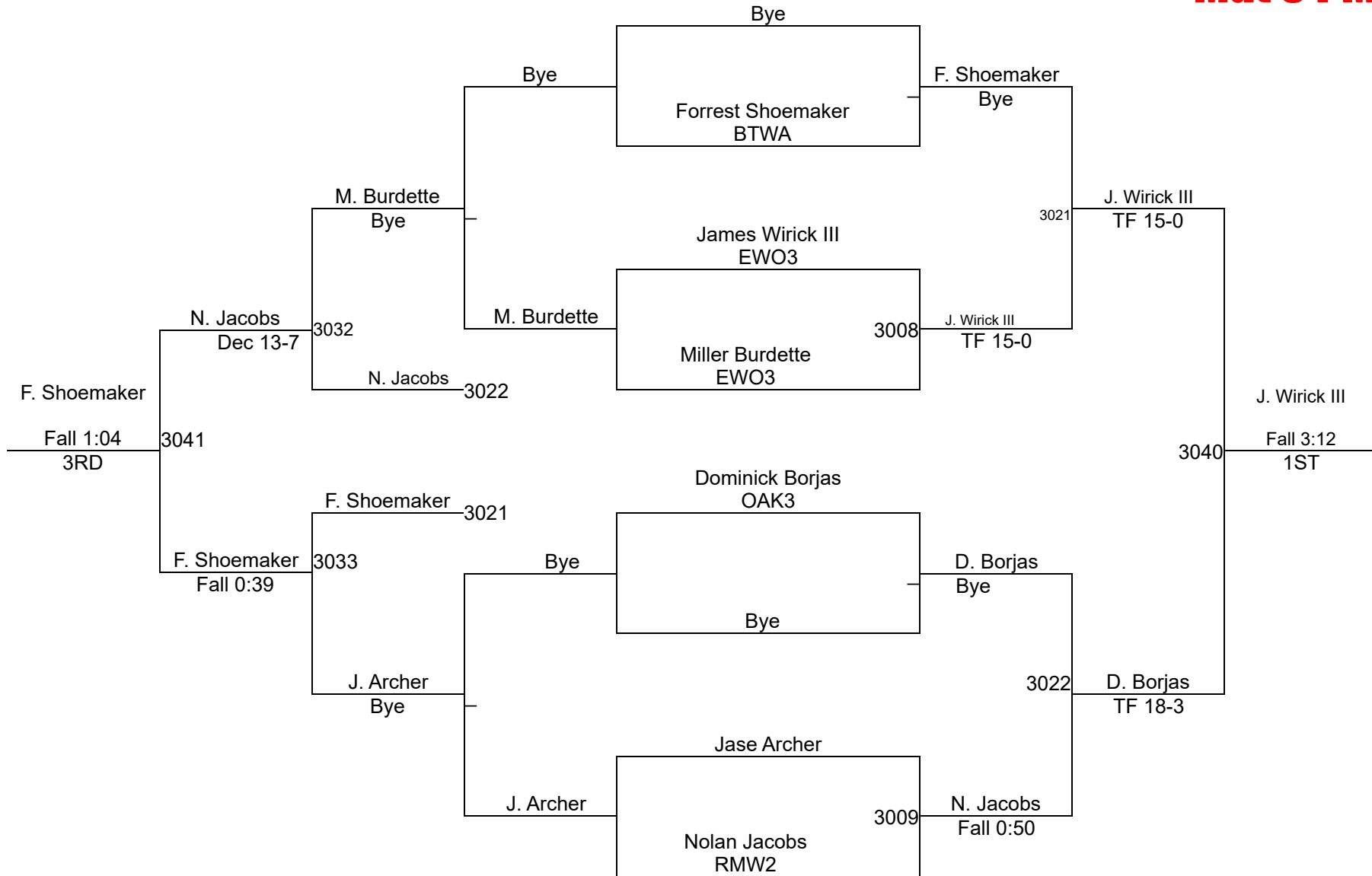

Turkey Takedown-OACPts-Open/Novice

Divison 4 Open 72-75
Mat 3 PM

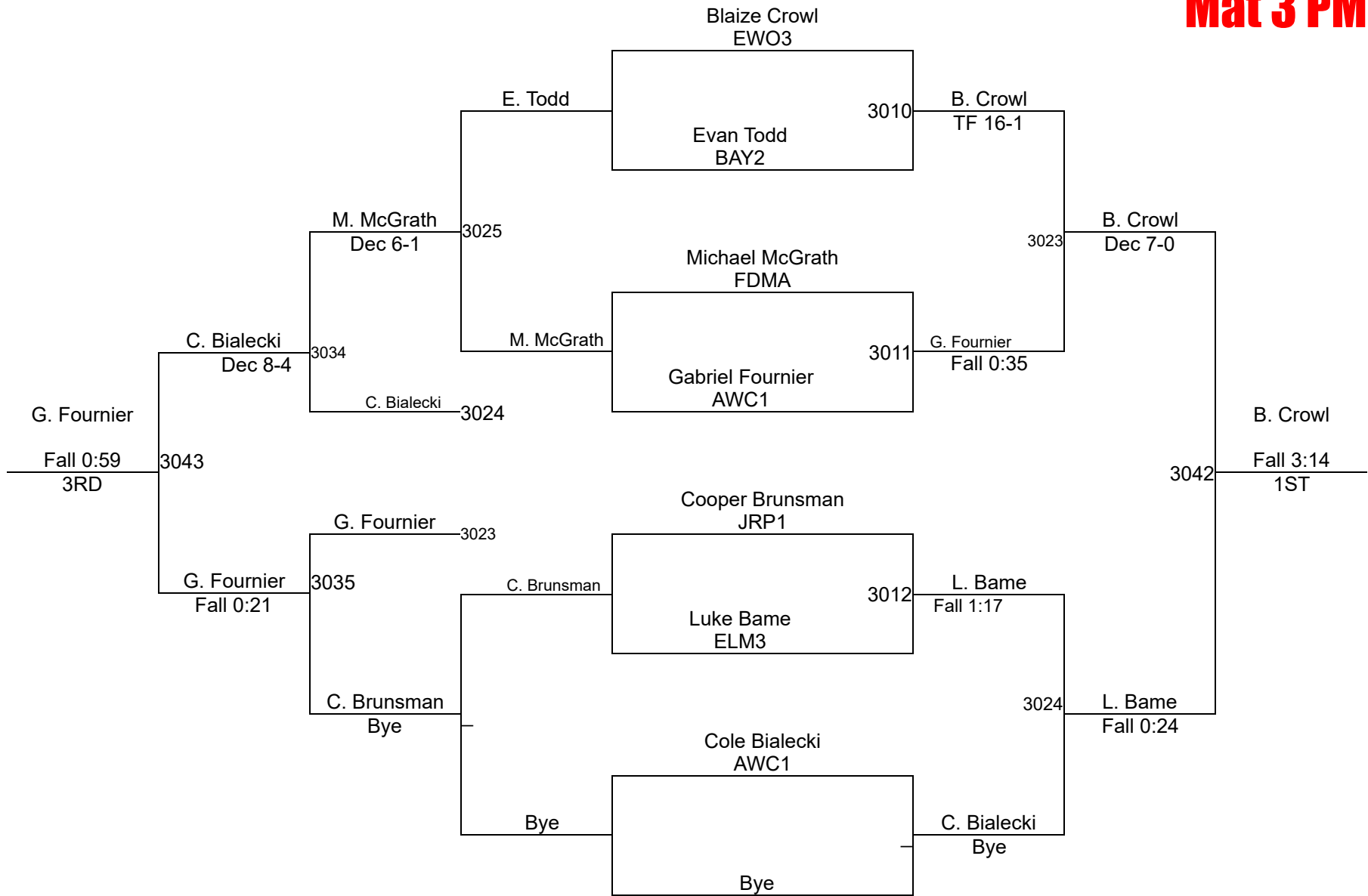

Turkey Takedown-OACPts-Open/Novice

Divison 4 Open 76-85
Mat 4 PM

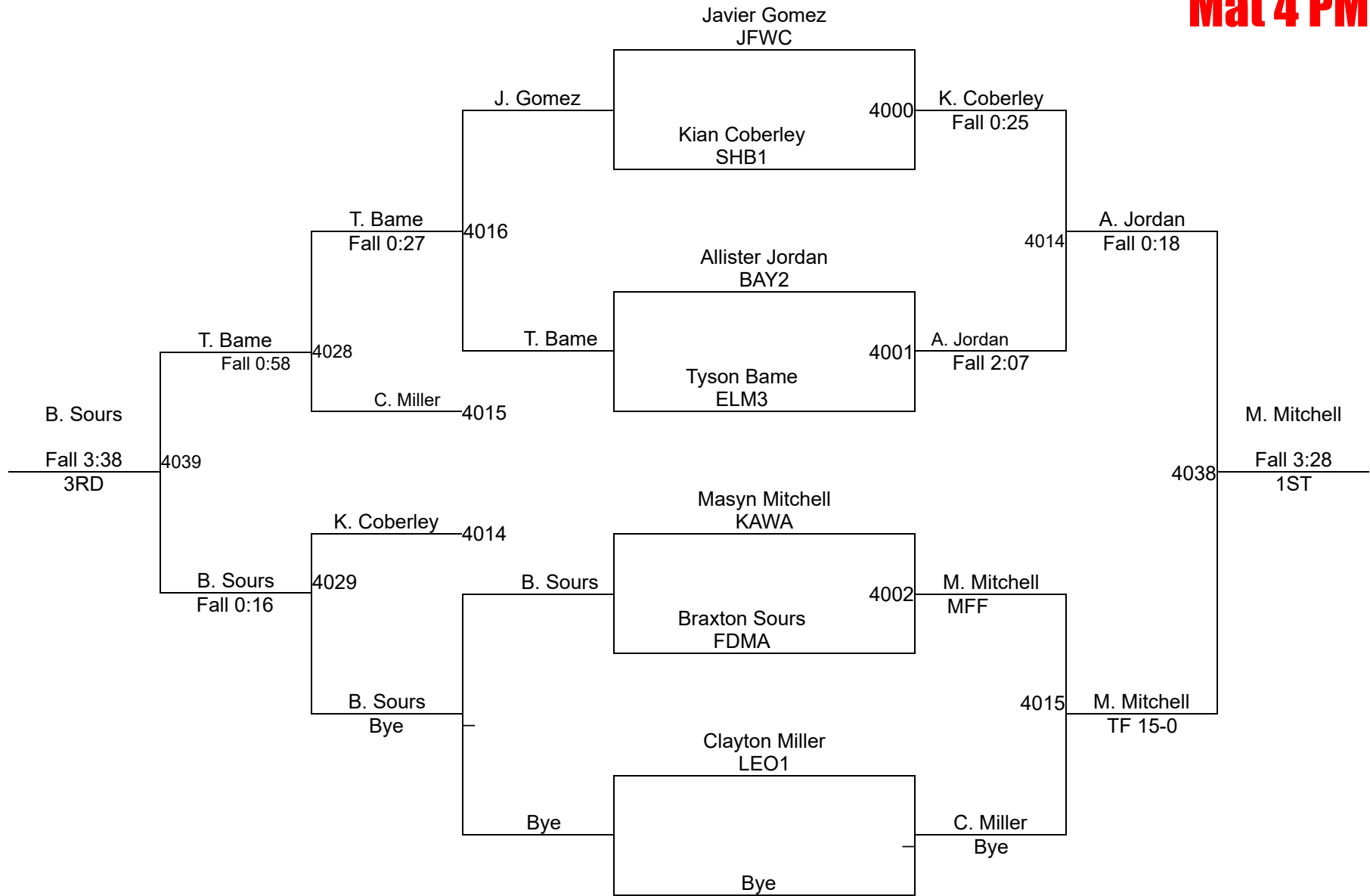

Turkey Takedown-OACPts-Open/Novice

Divison 4 Open 83-87
Mat 4 PM

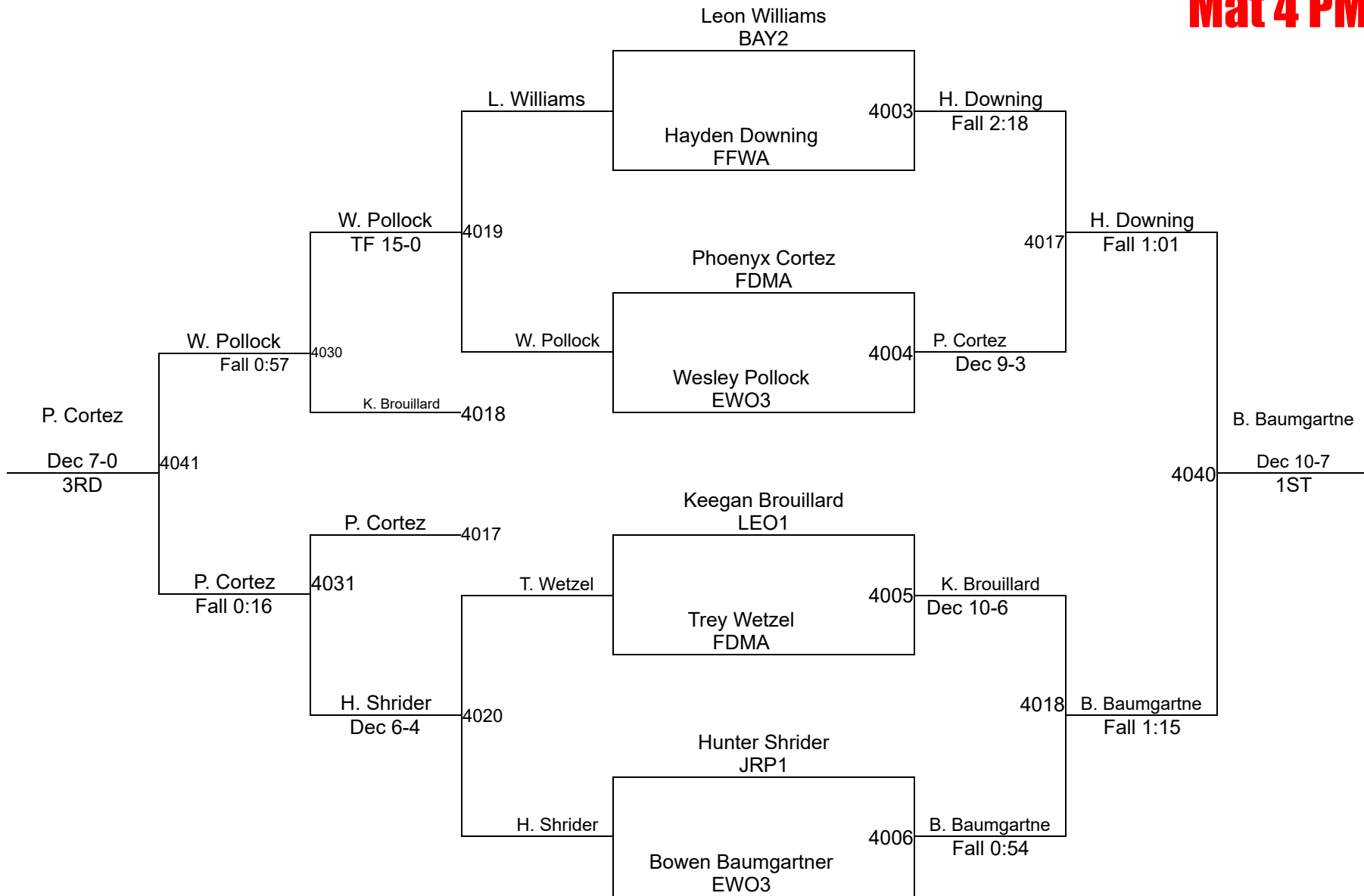

Turkey Takedown-OACPts-Open/Novice

Divison 4 Open 88-97
Mat 4 PM

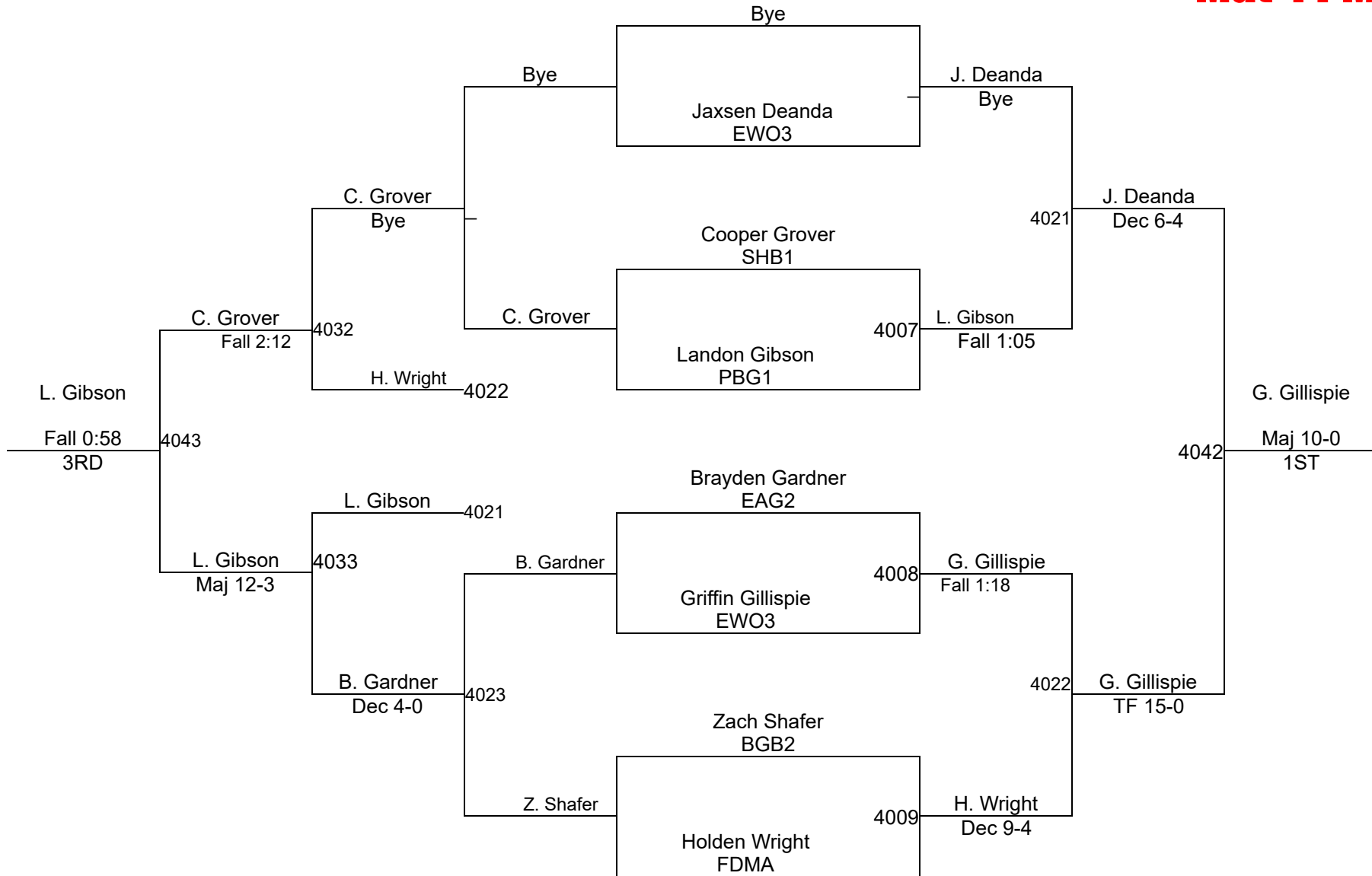

Turkey Takedown-OACPts-Open/Novice

Divison 4 Open 99-108

Mat 4 PM

Round 1

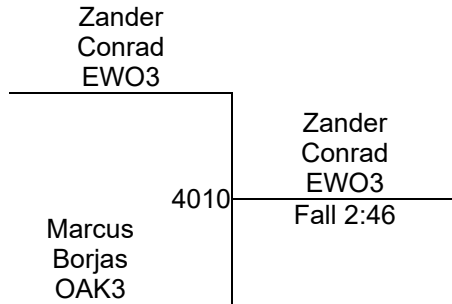

Round 2

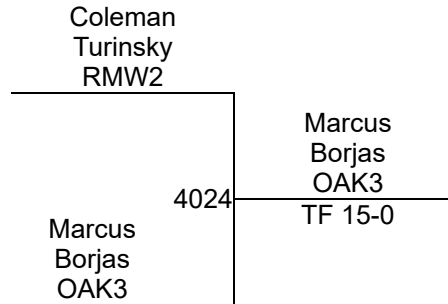

Round 3

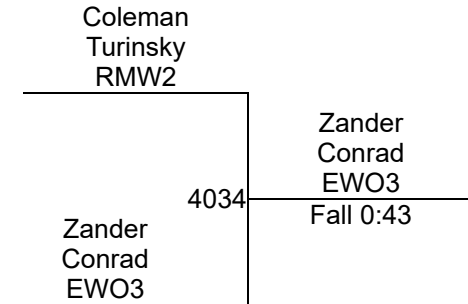

Z. Conrad (EWO3)

1ST

M. Borjas (OAK3)

2ND

C. Turinsky (RMW2)

3RD

Turkey Takedown-OACPts-Open/Novice

Divison 4 Open 108-128

Mat 4 PM

Round 1

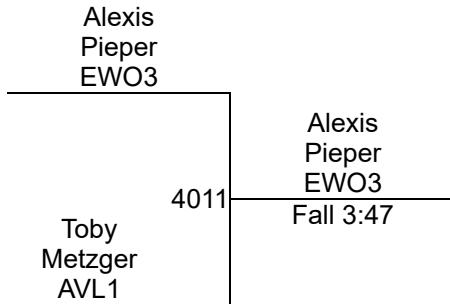

Round 2

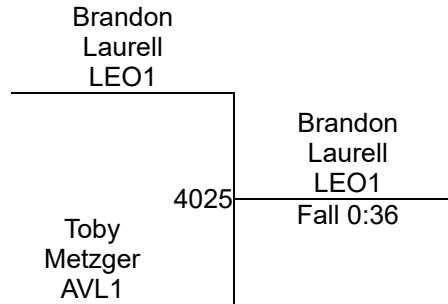

Round 3

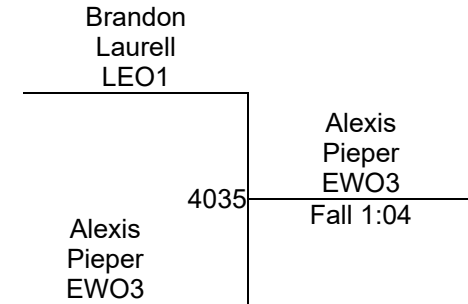

A. Pieper (EWO3)

1ST

B. Laurell (LEO1)

2ND

T. Metzger (AVL1)

3RD

Turkey Takedown-OACPts-Open/Novice

Divison 4 Open 141-155
Mat 4 PM

Round 1

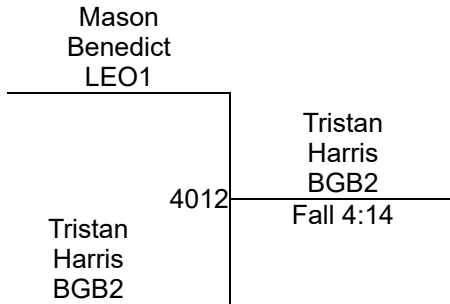

Round 2

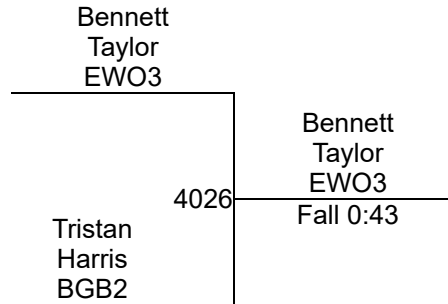

Round 3

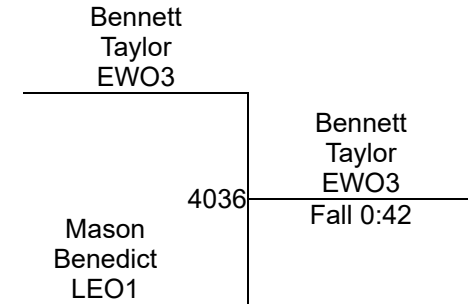

B. Taylor (EWO3)
1ST

T. Harris (BGB2)
2ND

M. Benedict (LEO1)
3RD

Turkey Takedown-OACPts-Open/Novice

Divison 4 Open 167-183

Mat 4 PM

Round 1

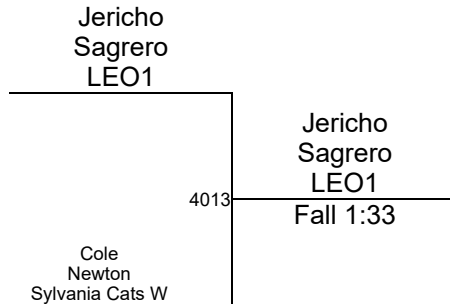

Round 2

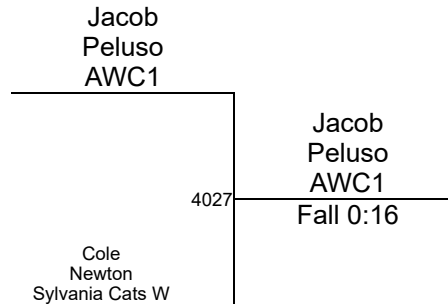

Round 3

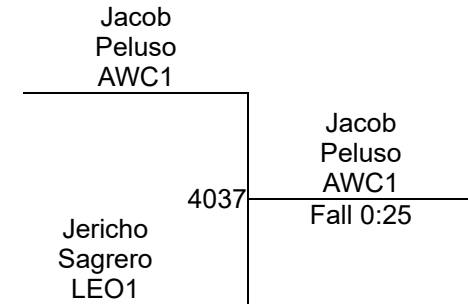

J. Peluso (AWC1)

1ST

J. Sagrero (LEO1)

2ND

C. Newton (Sylvania Cats Wrestling C)

3RD