

2023 OAC Lakota West GS District

Division I 40

Round 1

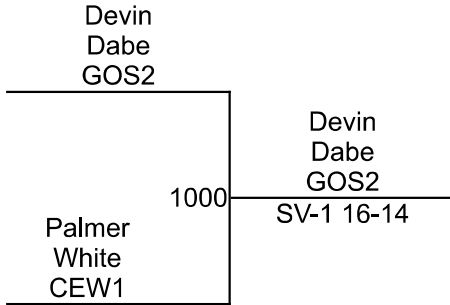

Round 2

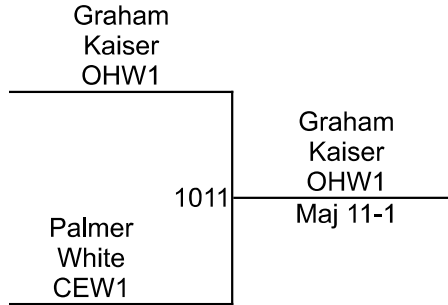

Round 3

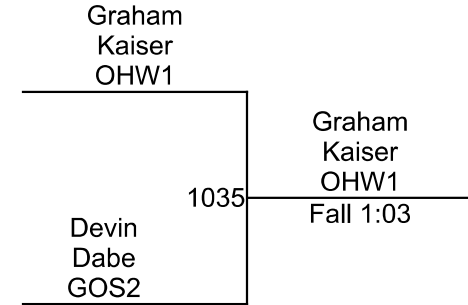

G. Kaiser (OHW1)

1ST

D. Dabe (GOS2)

2ND

P. White (CEW1)

3RD

2023 OAC Lakota West GS District

Division I 45

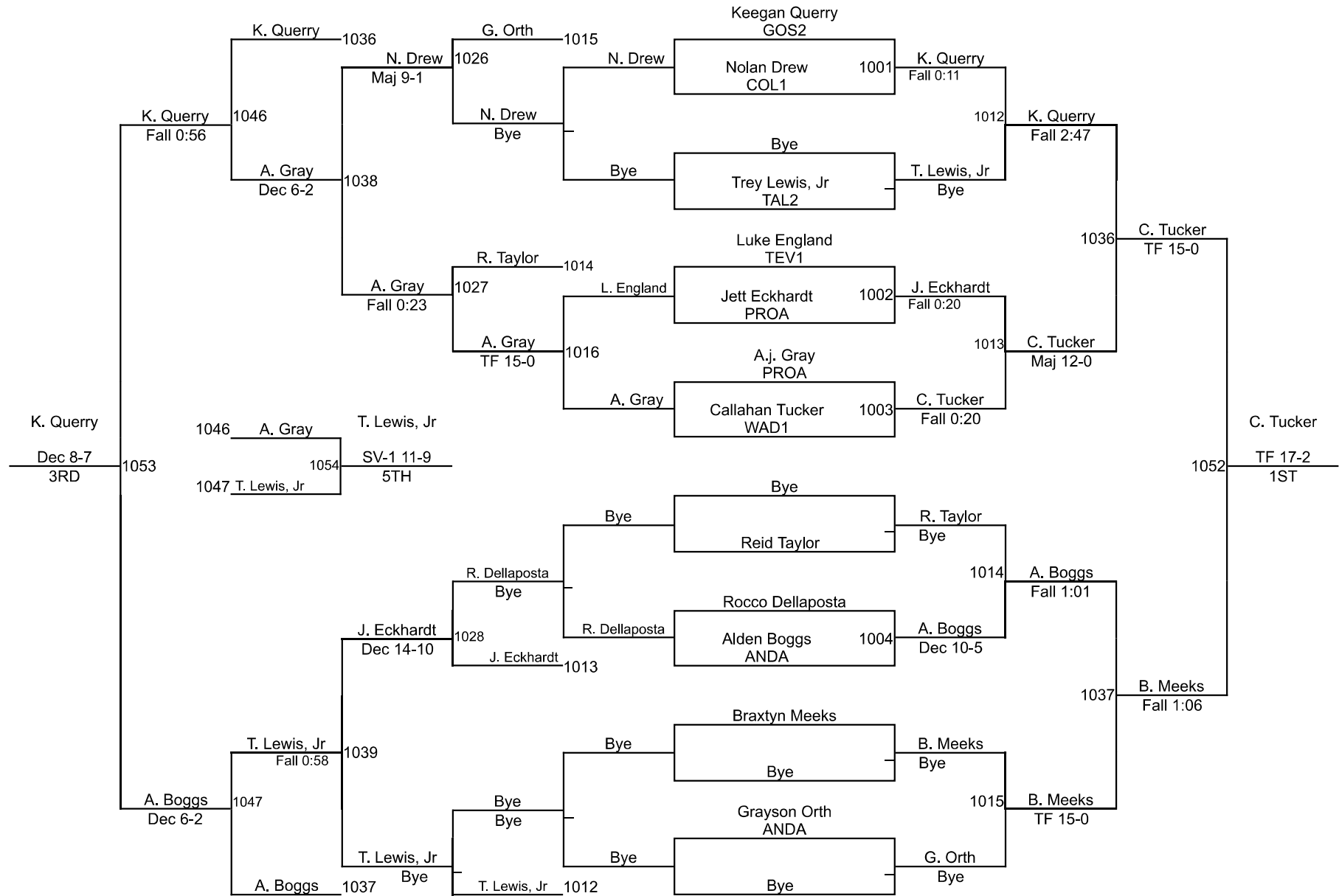

2023 OAC Lakota West GS District

Division I 50

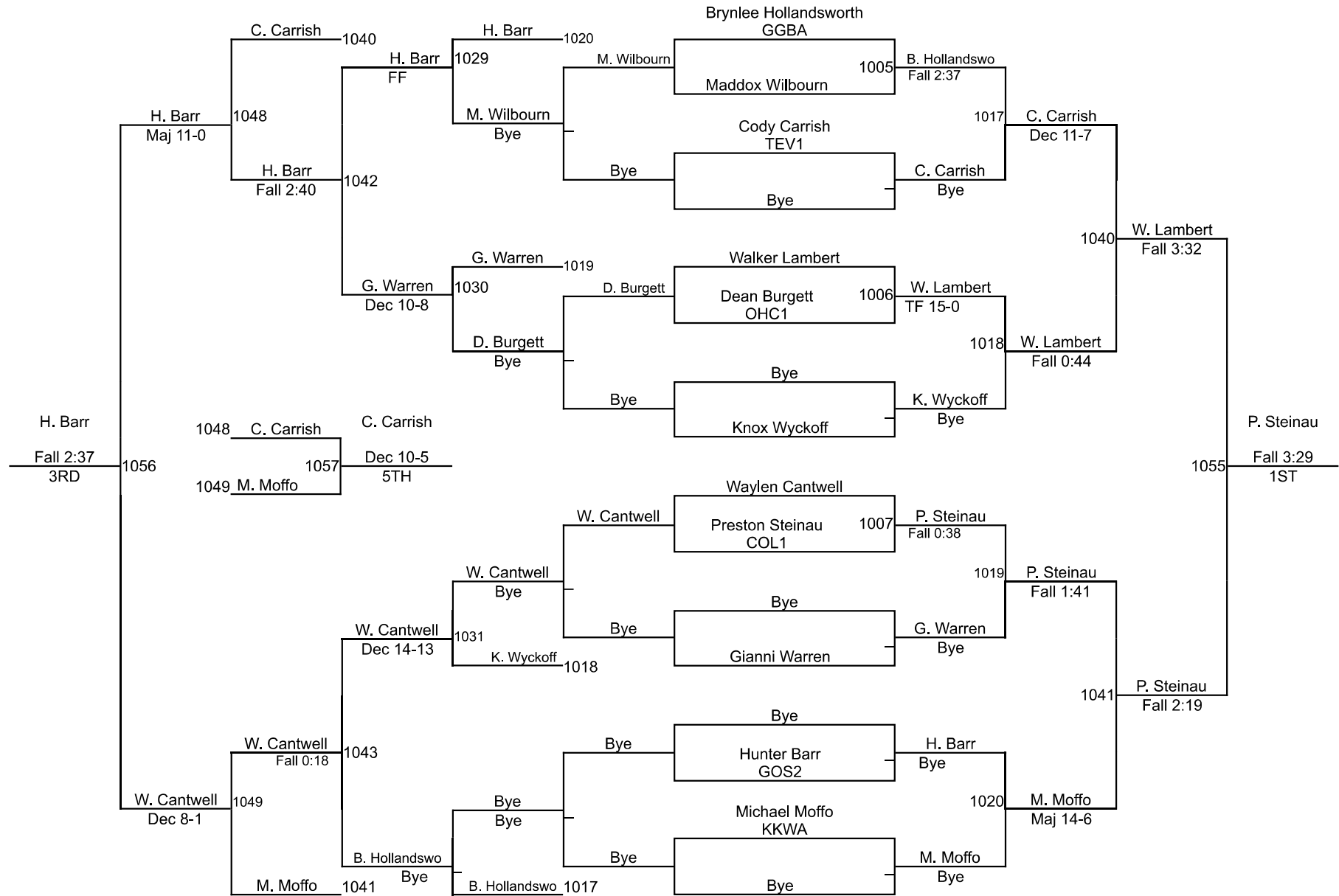

2023 OAC Lakota West GS District

Division I 55

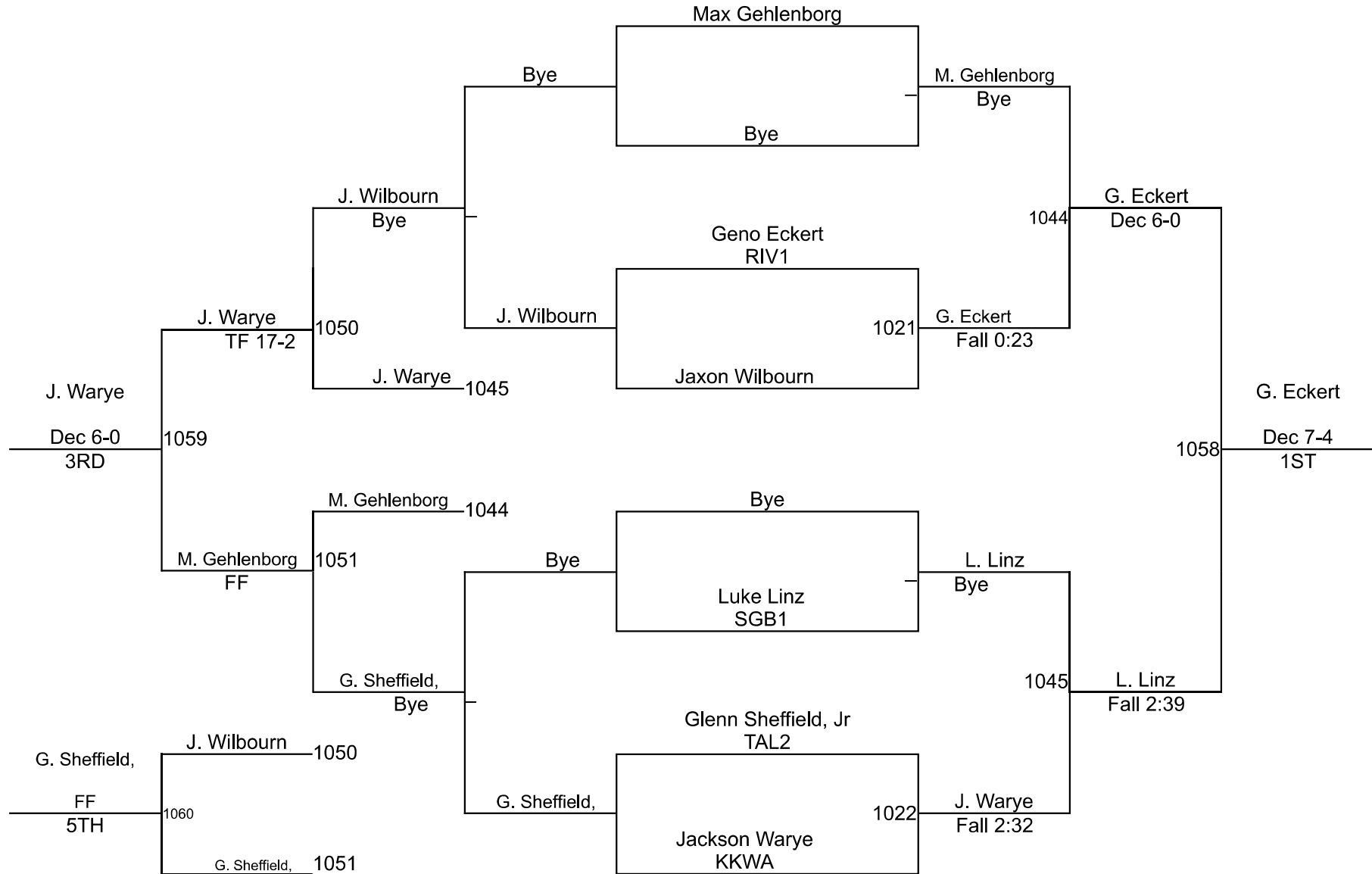

2023 OAC Lakota West GS District

Division I 60

Round 1

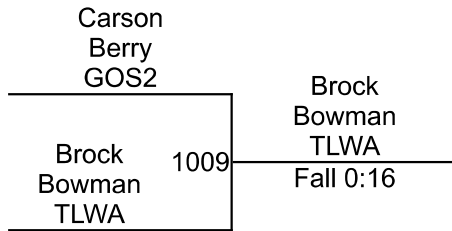
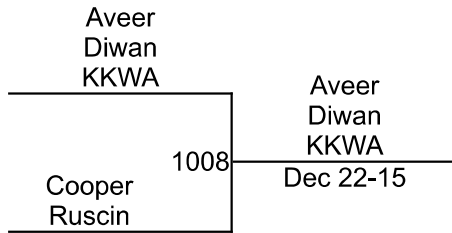

Round 2

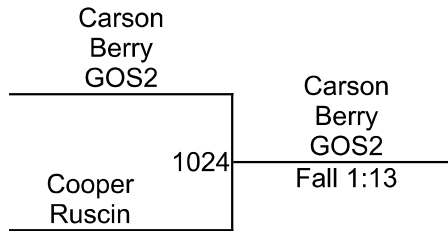
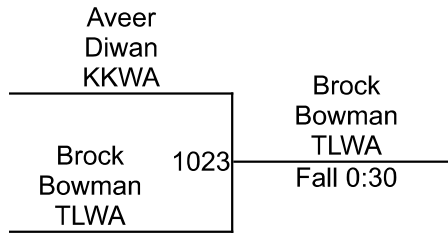

Round 3

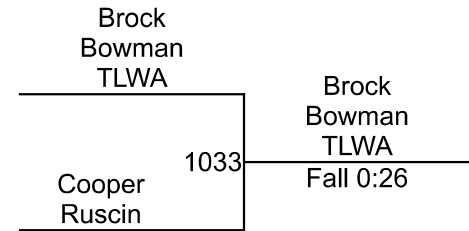
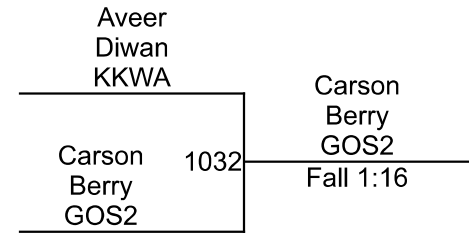

WRESTLERS

A. Diwan (KKWA)

C. Ruscin ()

C. Berry (GOS2)

B. Bowman (TLWA)

B. Bowman (TLWA)

1ST

C. Berry (GOS2)

2ND

A. Diwan (KKWA)

3RD

C. Ruscin ()

4TH

2023 OAC Lakota West GS District

Division I 75

Round 1

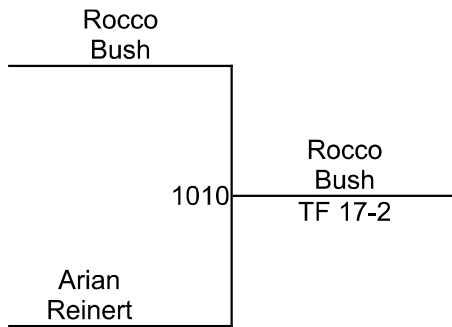

Round 2

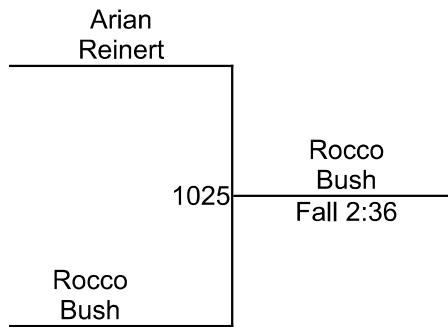

Round 3

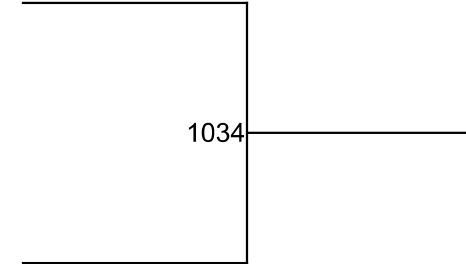

R. Bush ()
1ST

A. Reinert ()
2ND

2023 OAC Lakota West GS District

Division II 45

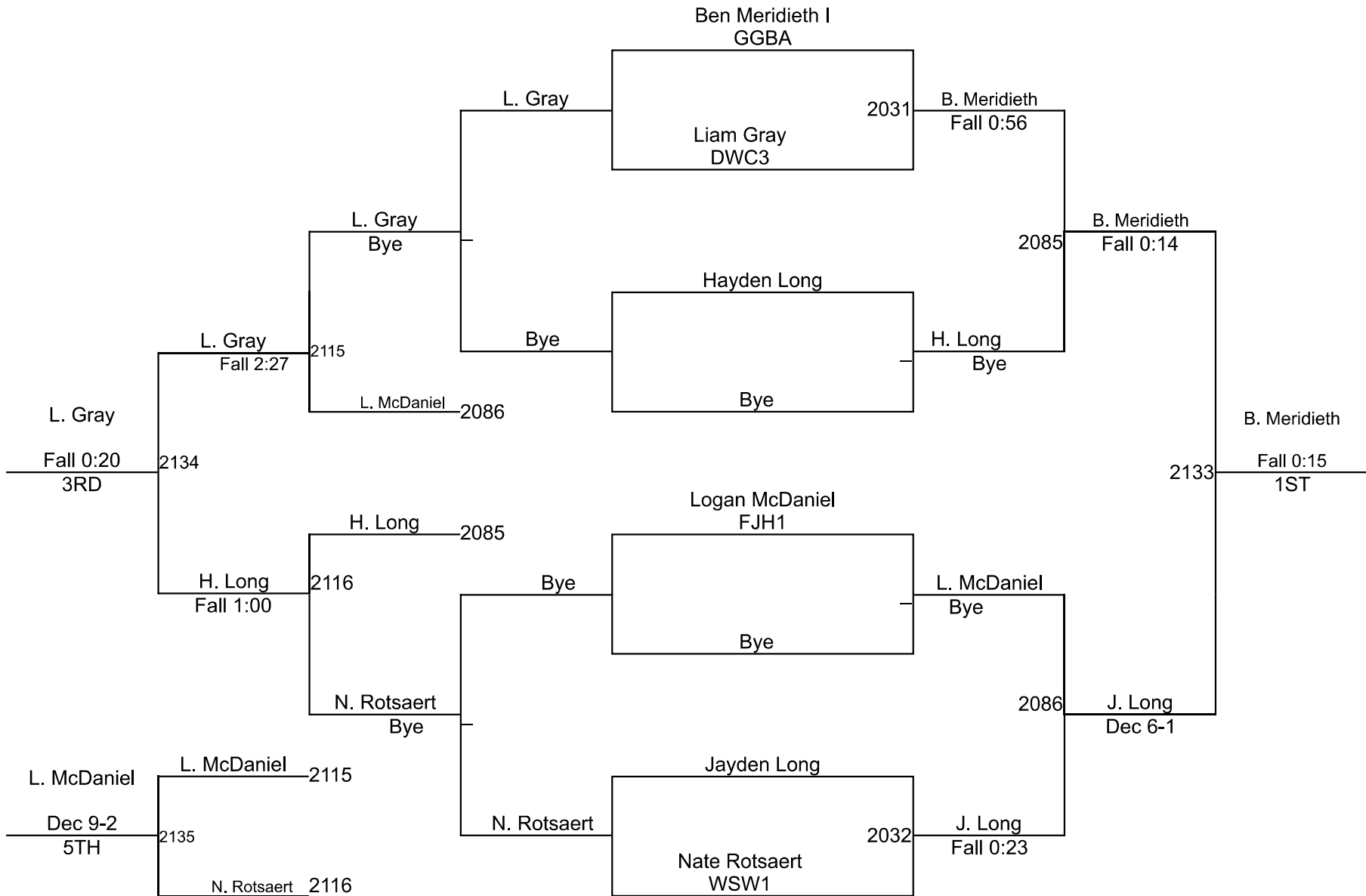

2023 OAC Lakota West GS District

Division II 55

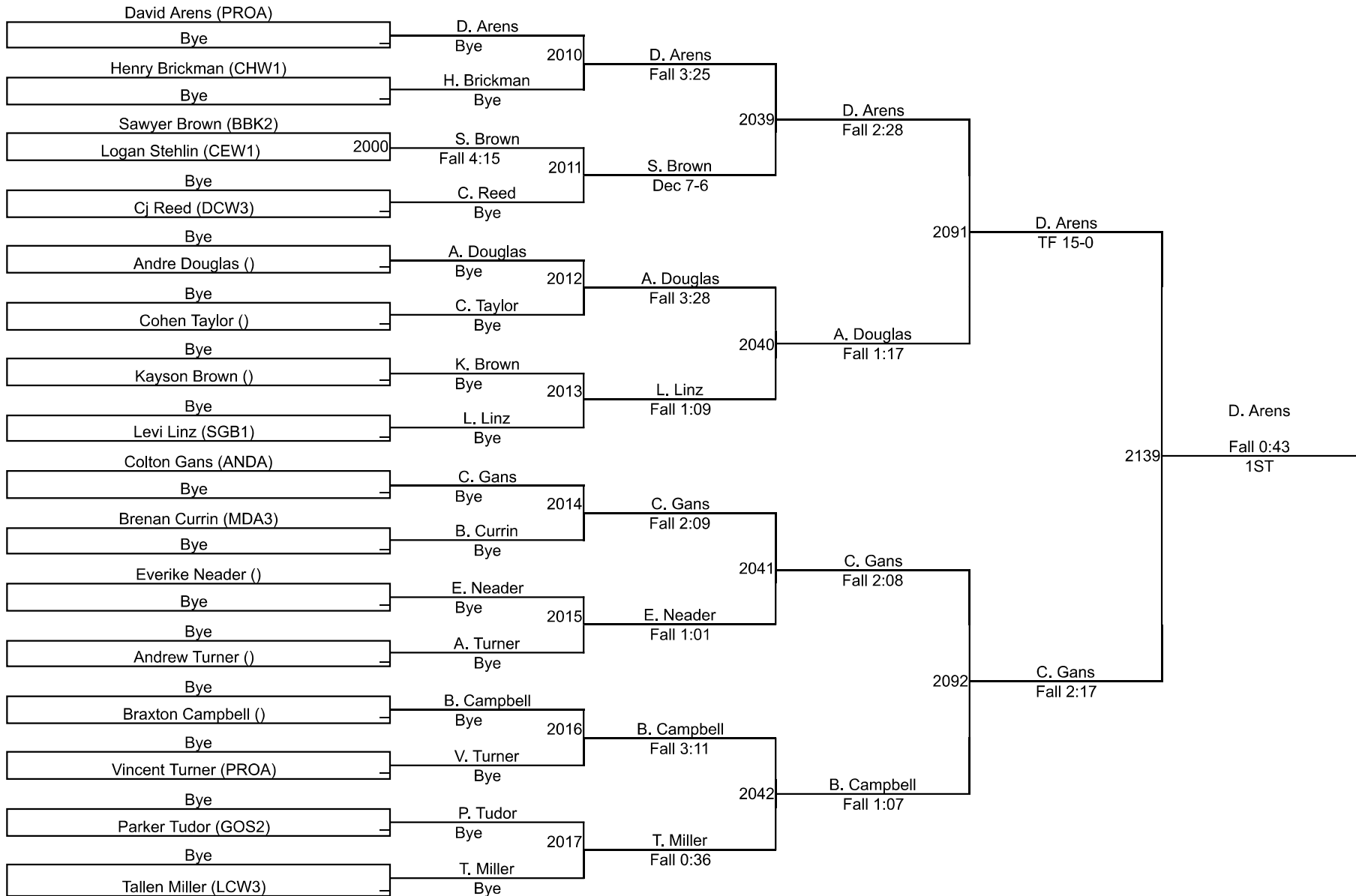

Division II 55

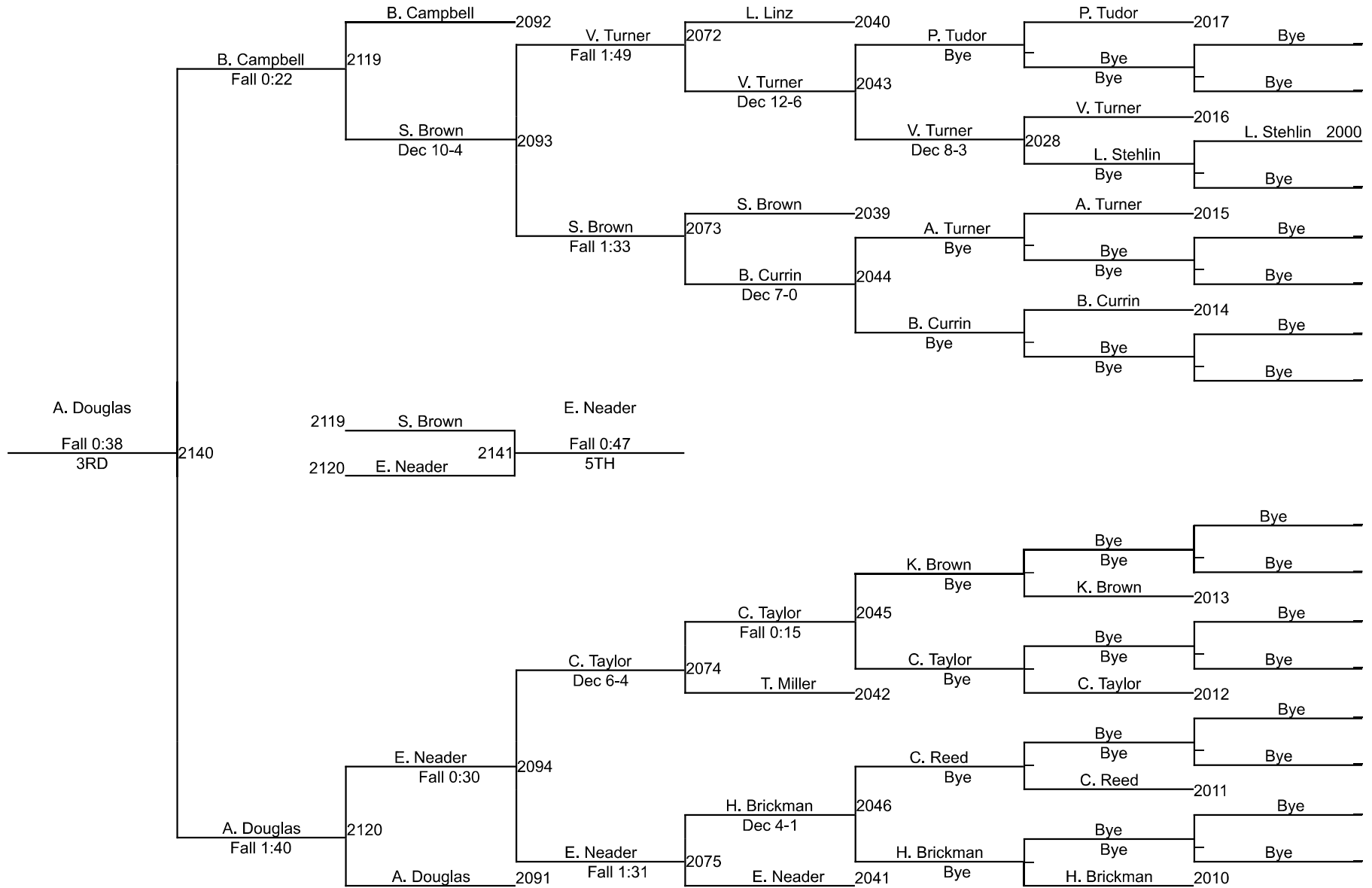

2023 OAC Lakota West GS District

Division II 58

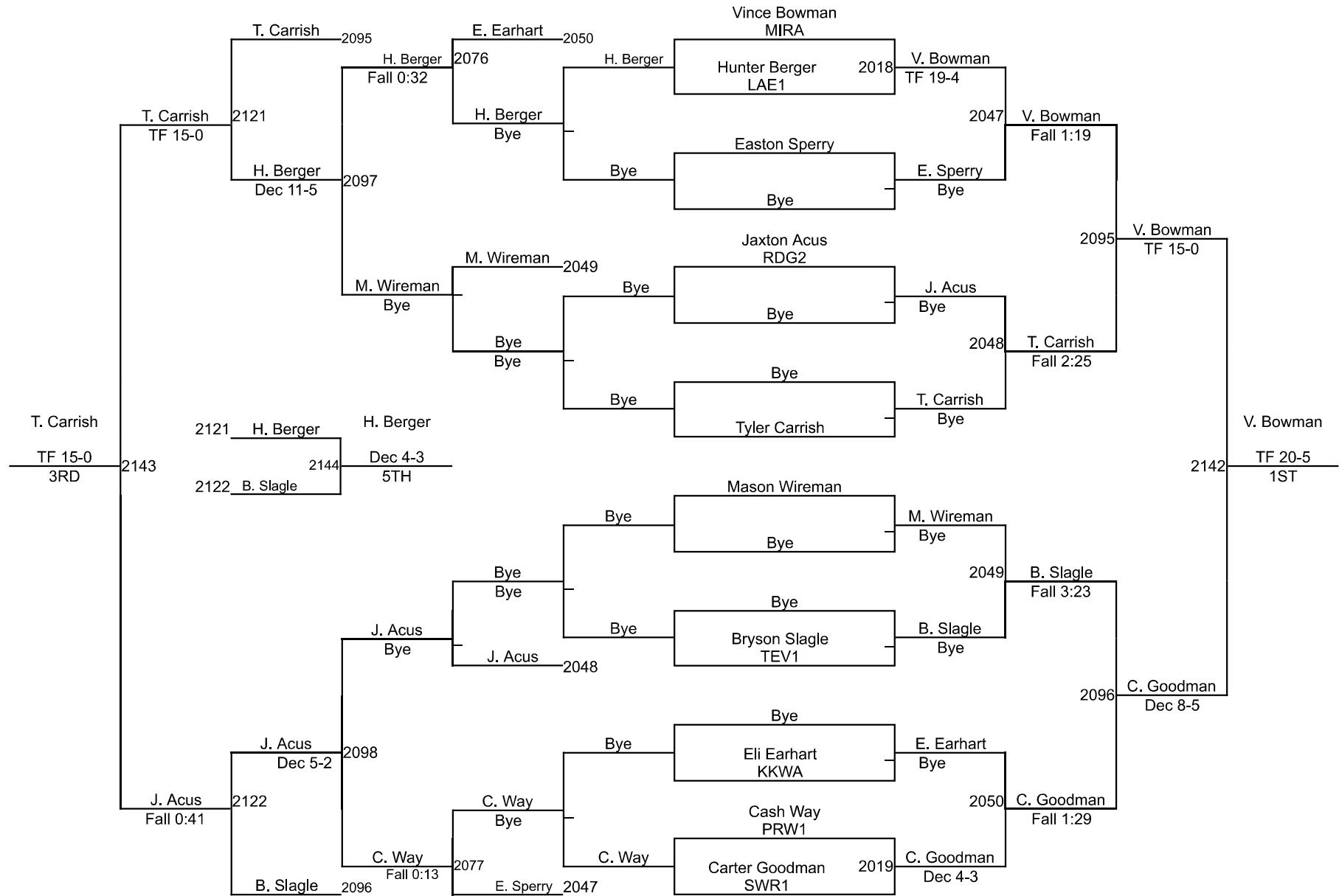

2023 OAC Lakota West GS District

Division II 61

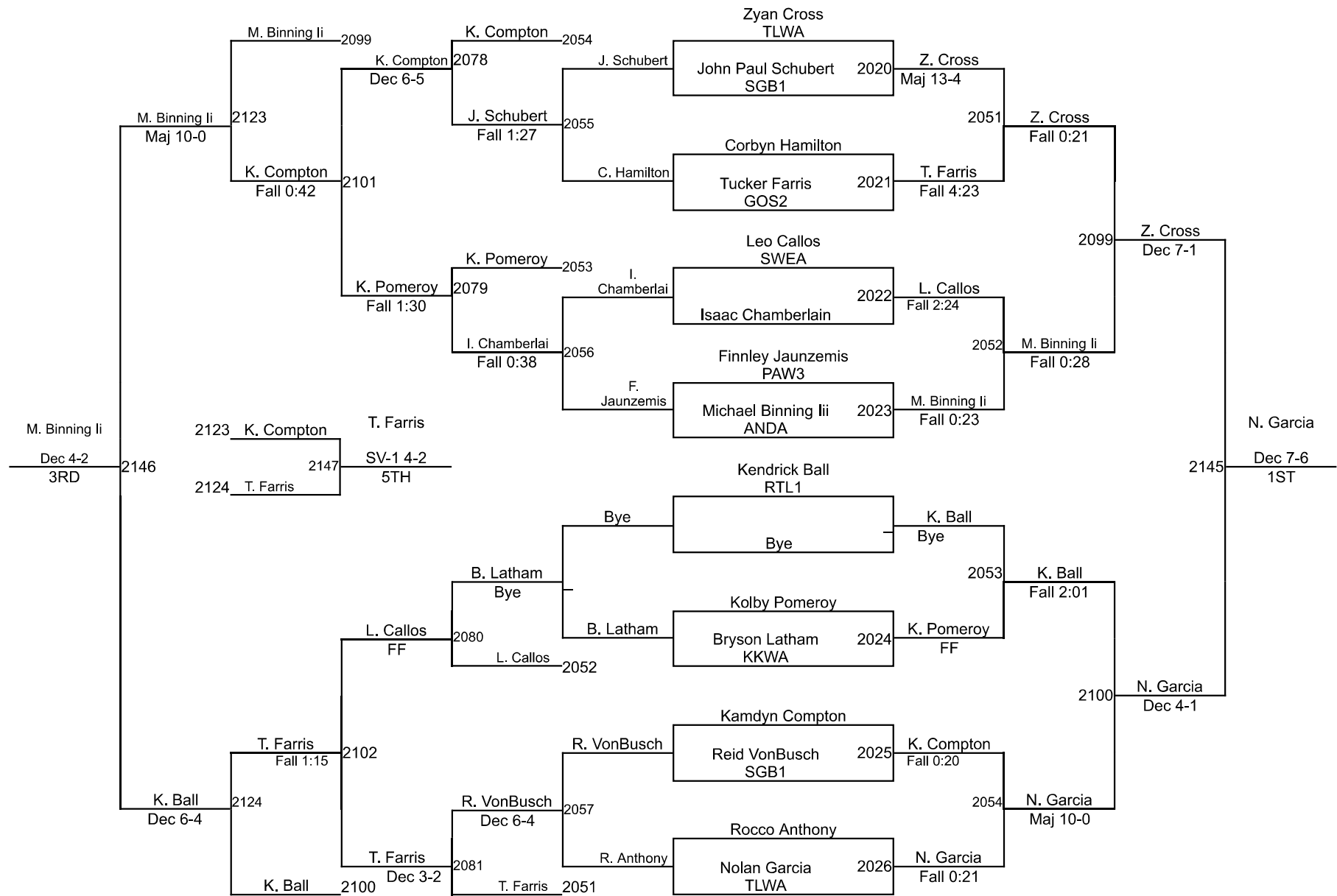

2023 OAC Lakota West GS District

Division II 65

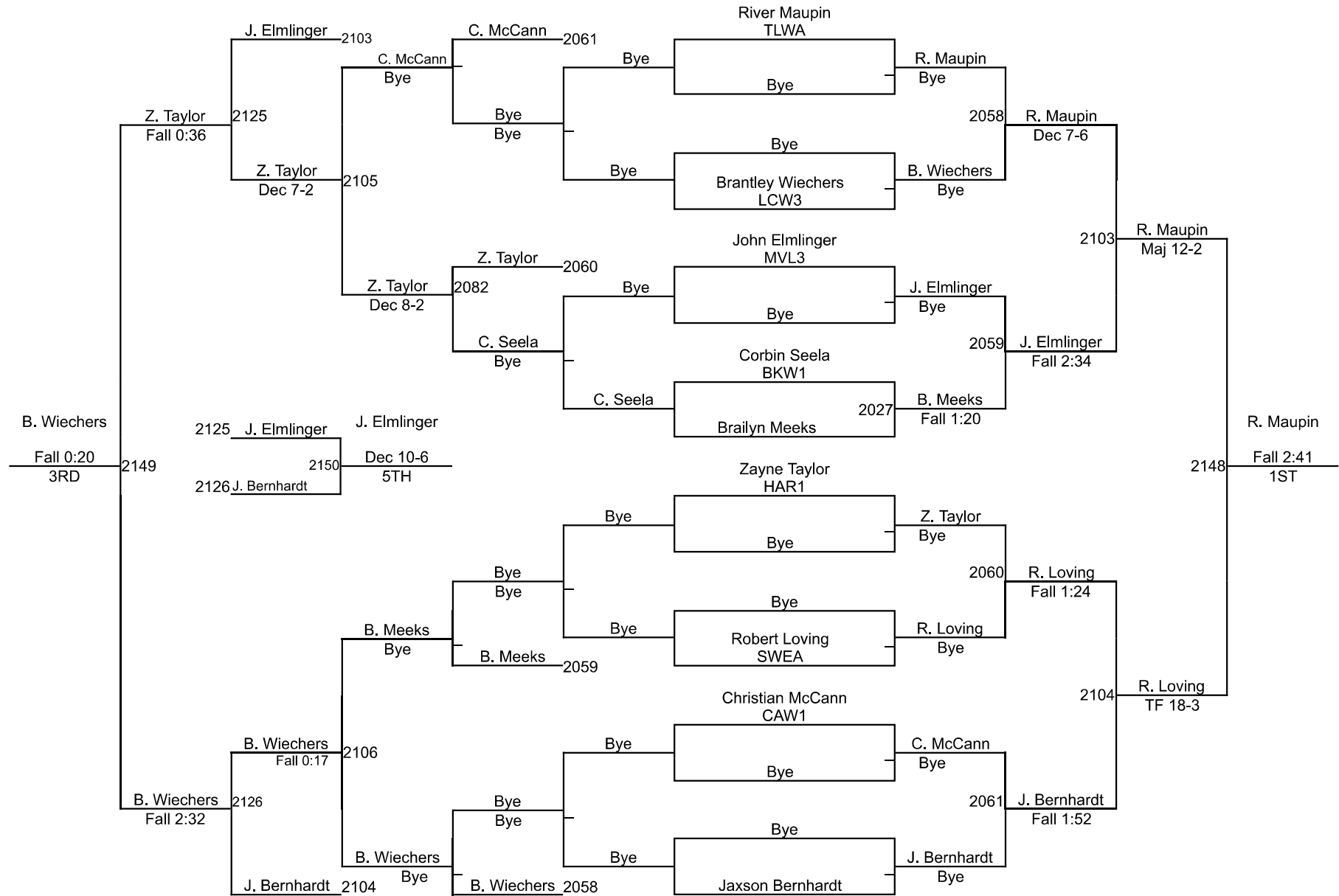

2023 OAC Lakota West GS District

Division II 70

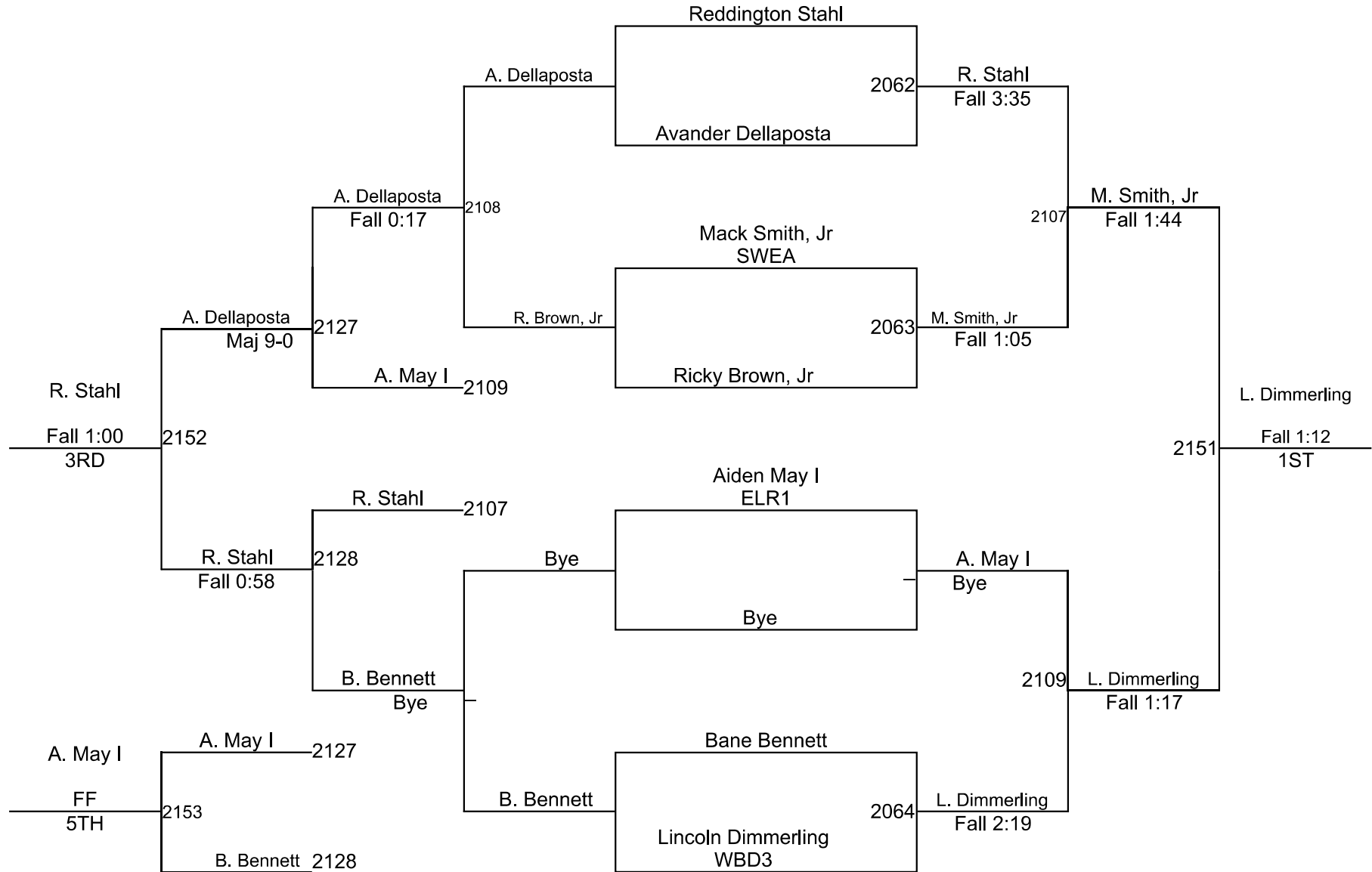

2023 OAC Lakota West GS District

Division II 75

Round 1

Kingston Simms RTL1	Kingston Simms RTL1
Marcus Rideout OHC1	Maj 9-1
2001	

Jax Ayars	Jax Ayars
Bryan Glancy SWEA	Fall 1:24
2002	

K. Simms (RTL1)
1ST

Round 2

Drayden Bacon GOS2	Drayden Bacon GOS2
Bryan Glancy SWEA	Fall 0:44
2029	

Kingston Simms RTL1	Jax Ayars
Jax Ayars	Fall 0:46
2030	

M. Rideout (OHC1)
2ND

Round 3

Drayden Bacon GOS2	Drayden Bacon GOS2
Jax Ayars	Fall 4:18
2083	

Marcus Rideout OHC1	Marcus Rideout OHC1
Bryan Glancy SWEA	Fall 0:20
2084	

D. Bacon (GOS2)
3RD

Round 4

Drayden Bacon GOS2	Marcus Rideout OHC1
Marcus Rideout OHC1	Fall 1:12
2110	

Kingston Simms RTL1	Kingston Simms RTL1
Bryan Glancy SWEA	Fall 1:15
2111	

J. Ayars ()
4TH

Round 5

Drayden Bacon GOS2	Kingston Simms RTL1
Kingston Simms RTL1	Fall 3:45
2129	

Marcus Rideout OHC1	Marcus Rideout OHC1
Jax Ayars	Dec 6-5
2130	

B. Glancy (SWEA)
5TH

2023 OAC Lakota West GS District

Division II 85

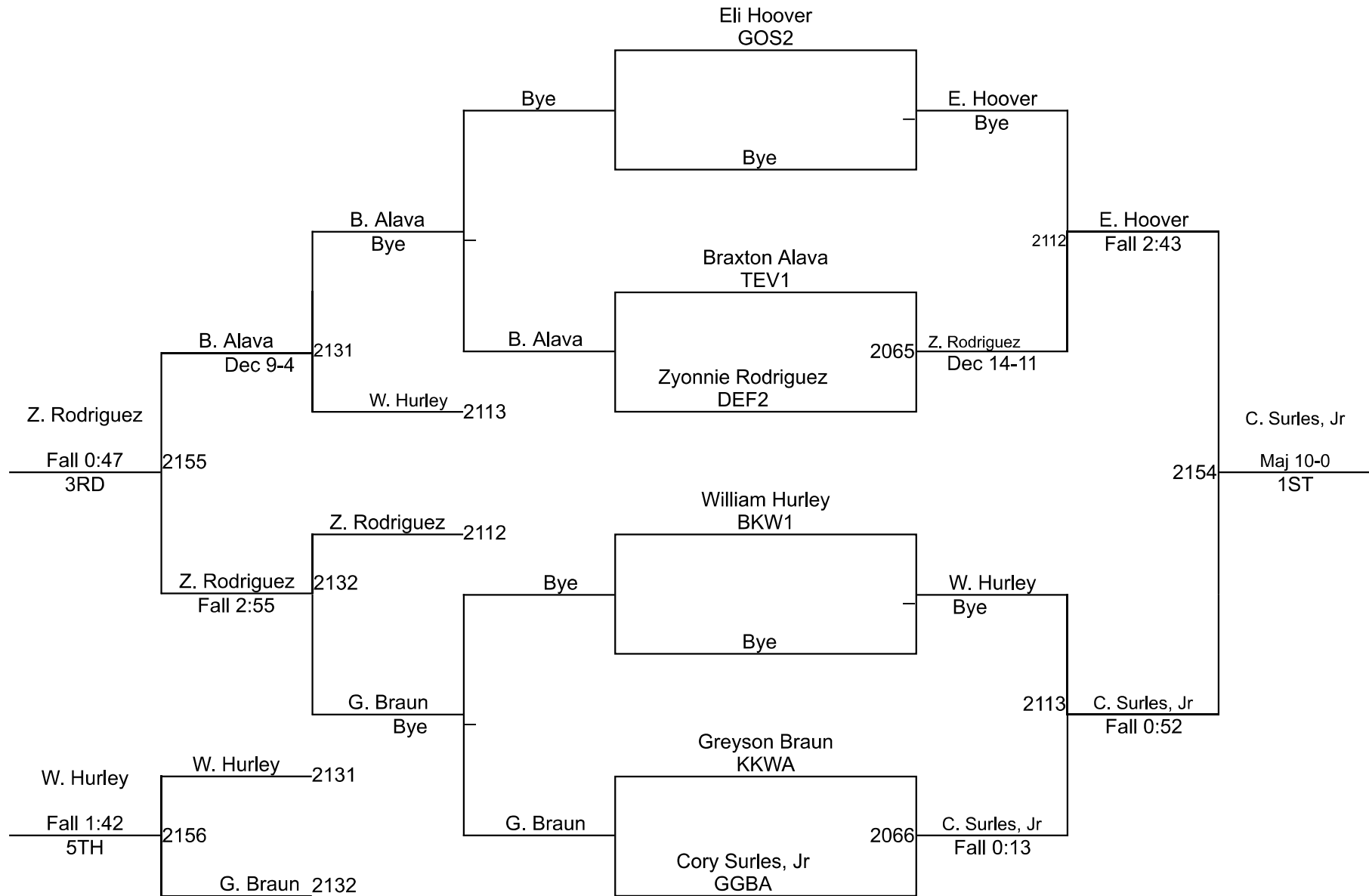

2023 OAC Lakota West GS District

Division II 120

Round 1

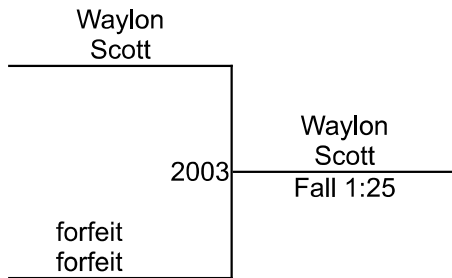

Round 2

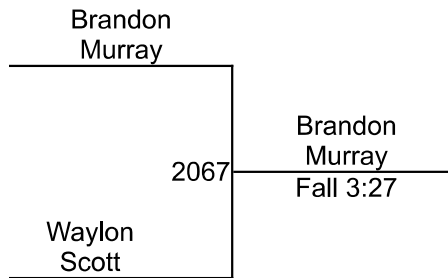

Round 3

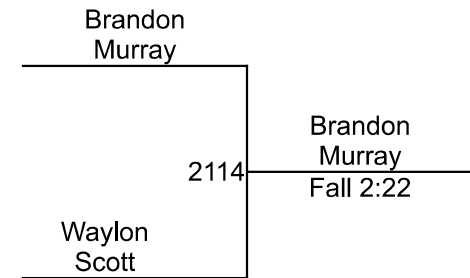

B. Murray ()

1ST

W. Scott ()

2ND

f. forfeit ()

3RD

2023 OAC Lakota West GS District

Division III 55

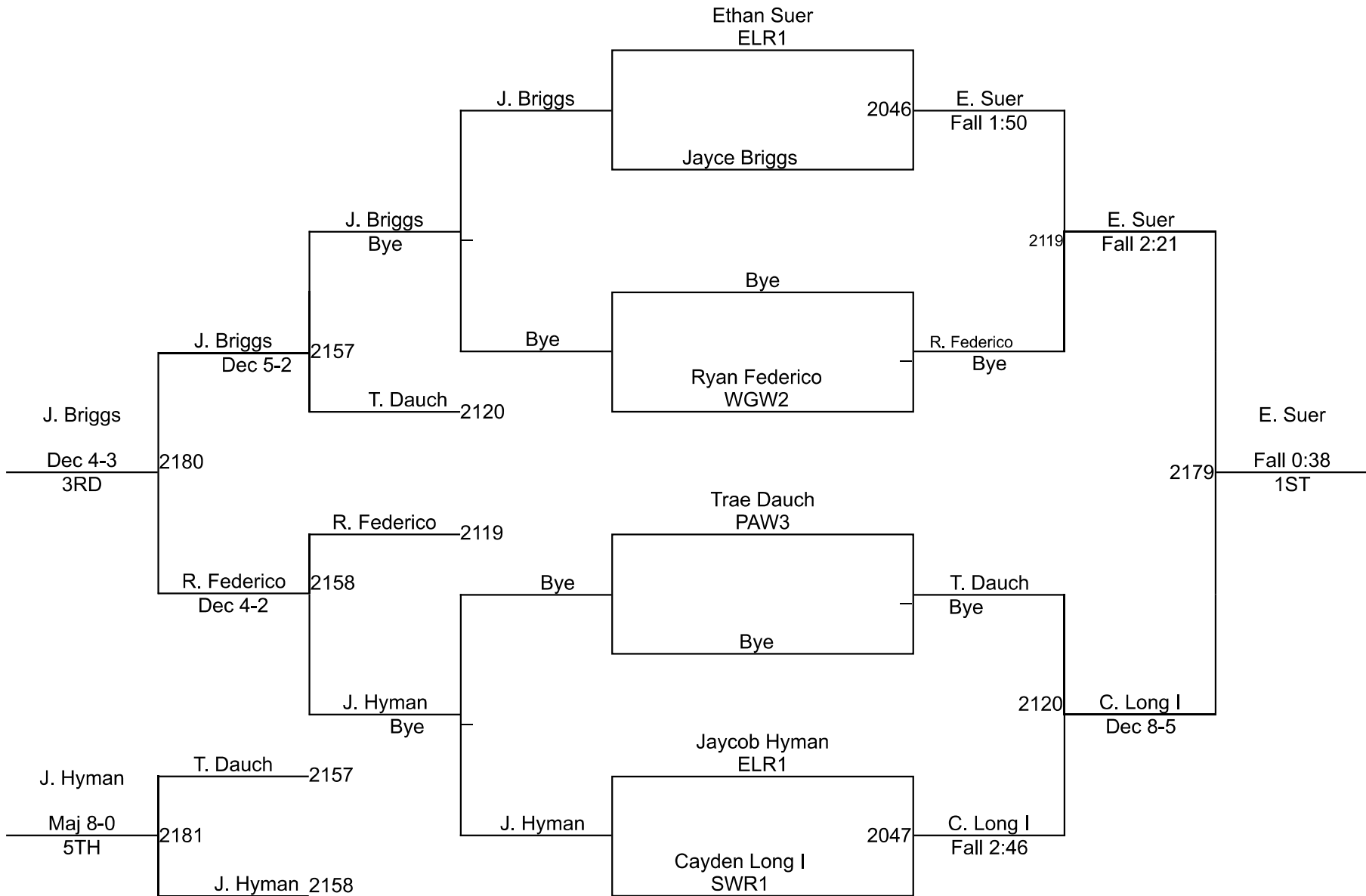

2023 OAC Lakota West GS District

Division III 65

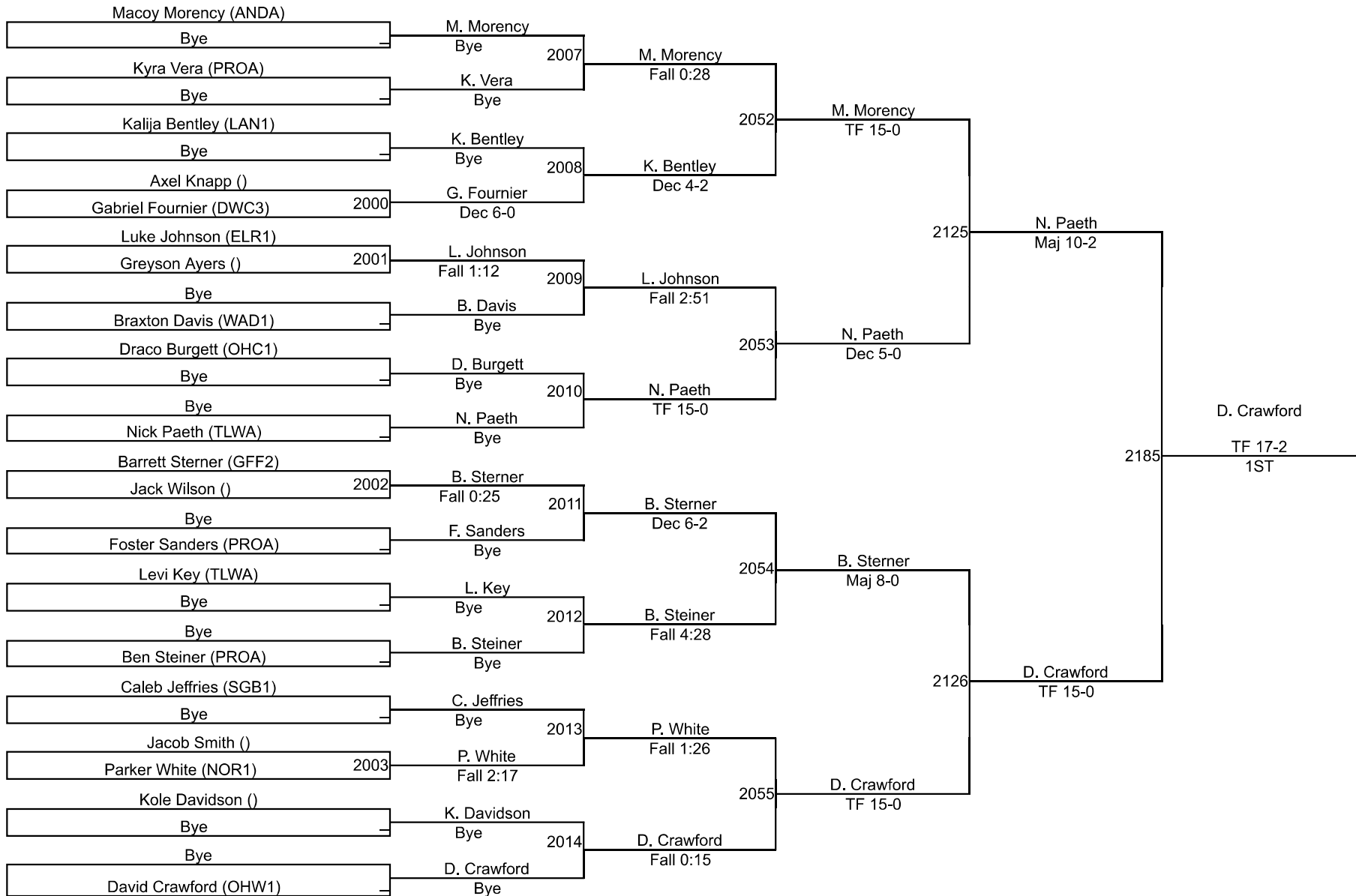

Division III 65

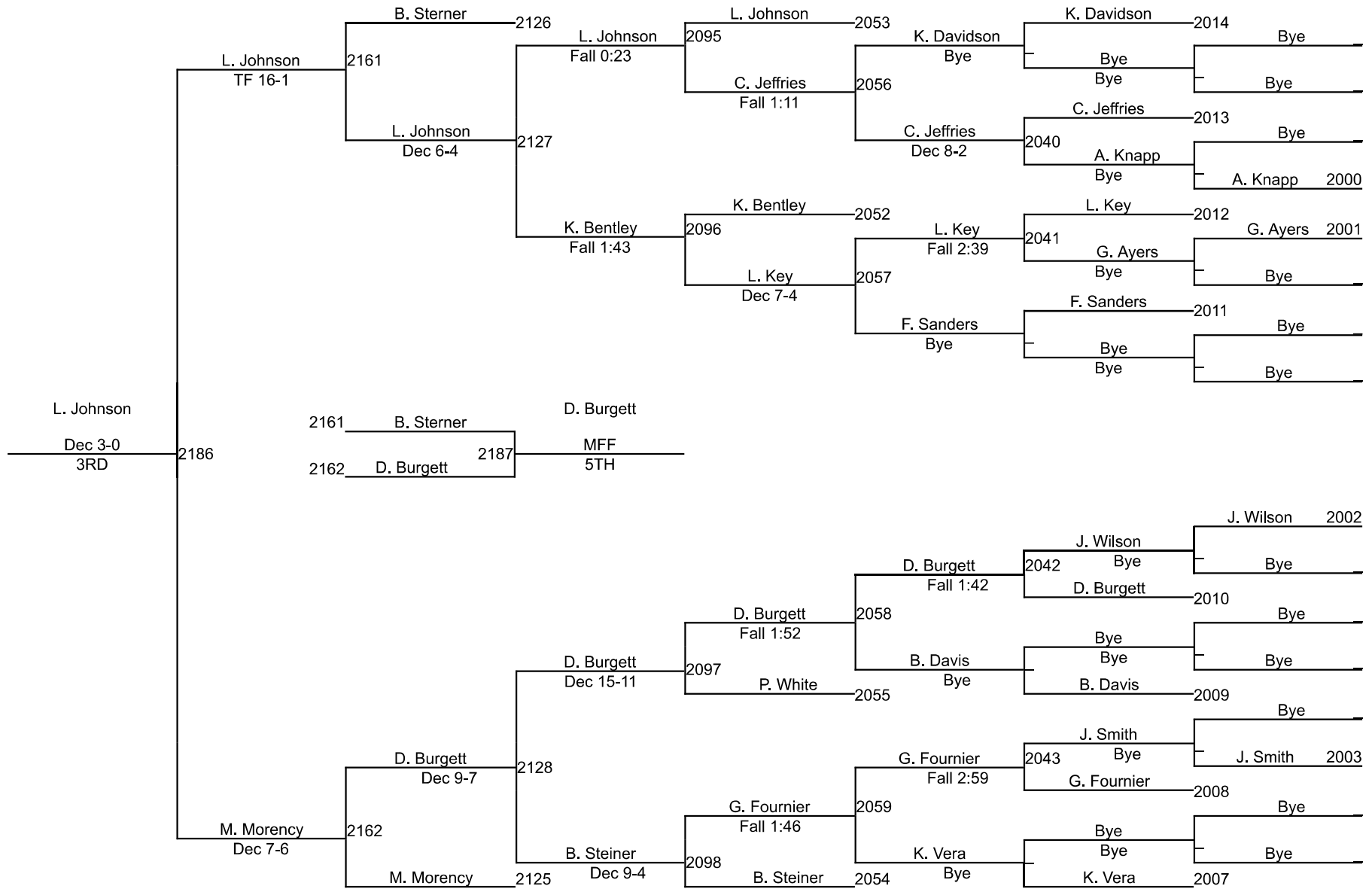

2023 OAC Lakota West GS District

Division III 75

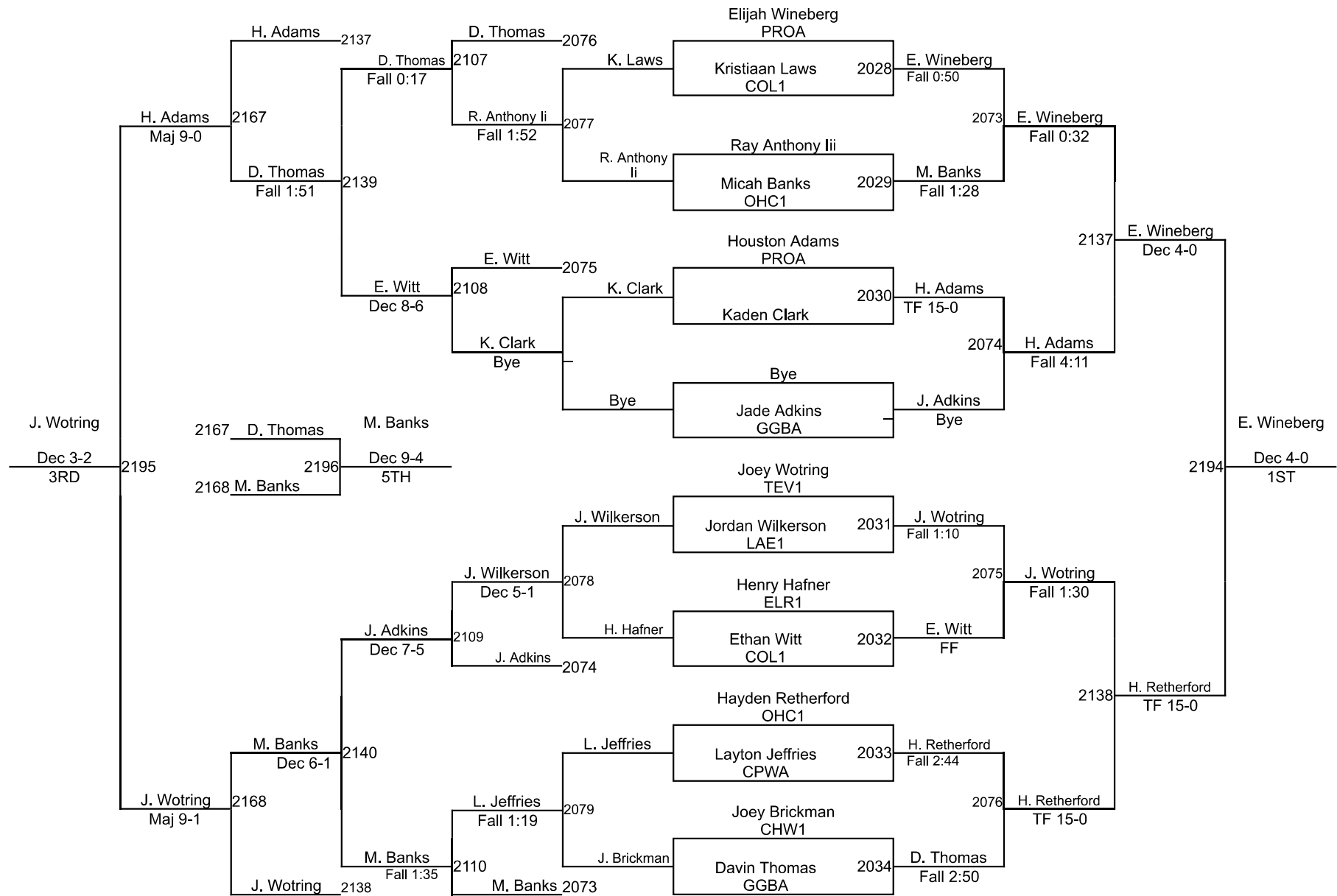

2023 OAC Lakota West GS District

Division III 80

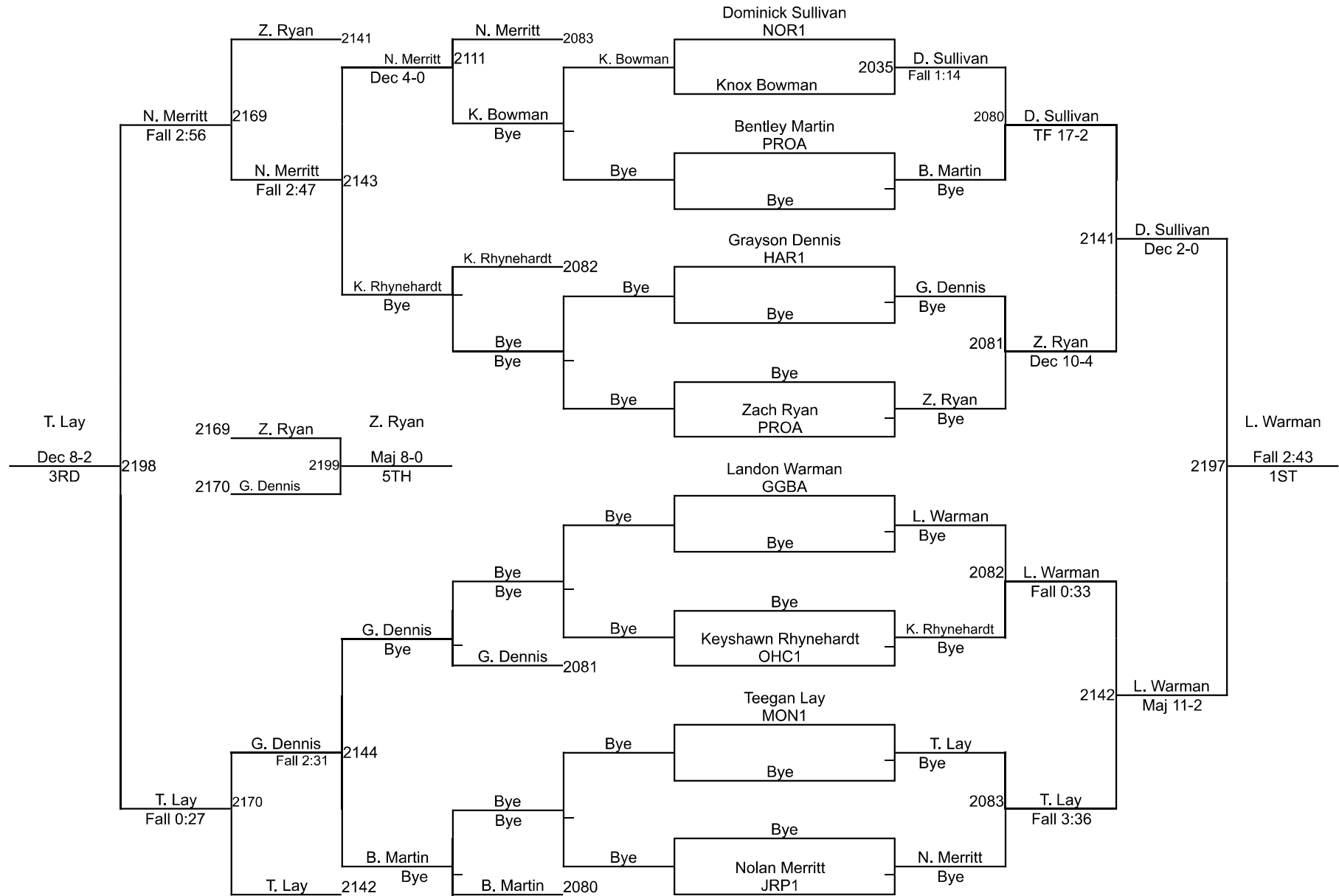

2023 OAC Lakota West GS District

Division III 85

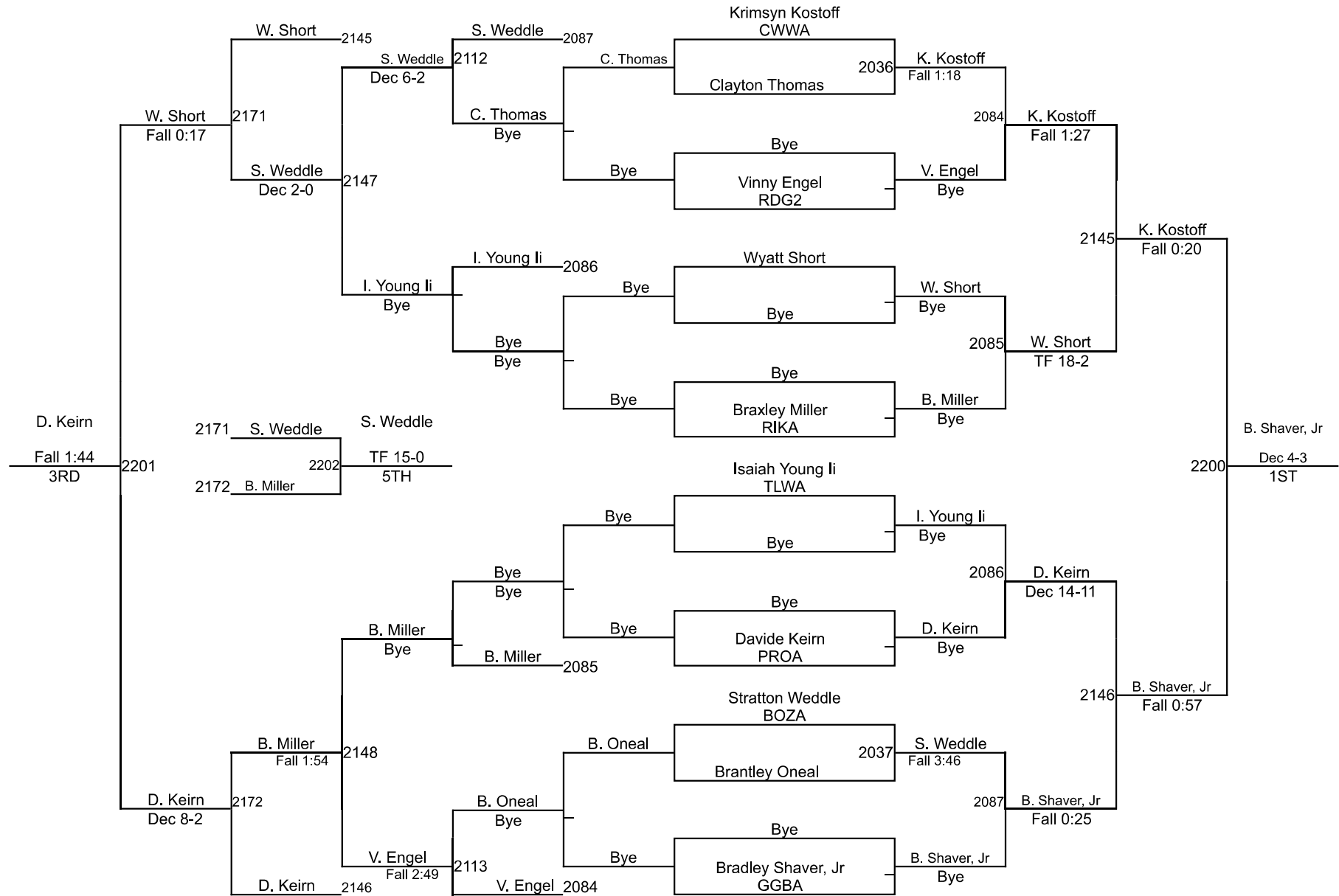

2023 OAC Lakota West GS District

Division III 110

Round 1

Paul Schulz LEB1	
Kayden Seagle 2004	Paul Schulz LEB1 Fall 2:29

Jason Wilkerson li LAE1	
Owen Stidham 2005 XGWA	Jason Wilkerson li LAE1 Dec 8-2

P. Schulz (LEB1)
1ST

Round 2

Zeke Romans GOS2	
Owen Stidham 2044 XGWA	Zeke Romans GOS2 Fall 0:57

Paul Schulz LEB1	
Jason Wilkerson li 2045 LAE1	Paul Schulz LEB1 Fall 2:11

Z. Romans (GOS2)
2ND

Round 3

Zeke Romans GOS2	
Jason Wilkerson li 2116 LAE1	Jason Wilkerson li LAE1 Dec 6-5

Kayden Seagle	
Owen Stidham 2117 XGWA	Kayden Seagle Fall 1:12

J. Wilkerson li (LAE1)
3RD

Round 4

Zeke Romans GOS2	
Kayden Seagle 2153	Zeke Romans GOS2 Fall 1:58

Paul Schulz LEB1	
Owen Stidham 2154 XGWA	Paul Schulz LEB1 Fall 0:27

K. Seagle ()
4TH

Round 5

Zeke Romans GOS2	
Paul Schulz 2175 LEB1	Zeke Romans GOS2 Dec 7-6

Kayden Seagle	
Jason Wilkerson li 2176 LAE1	Jason Wilkerson li LAE1 Fall 1:16

O. Stidham (XGWA)
5TH

2023 OAC Lakota West GS District

Division III 160

Round 1

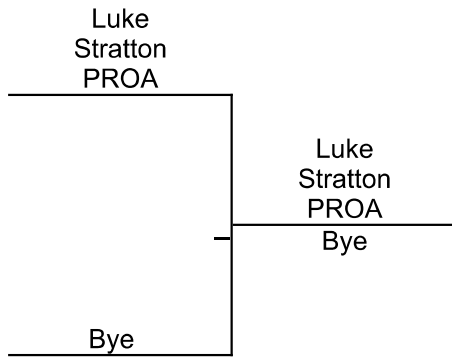

Round 2

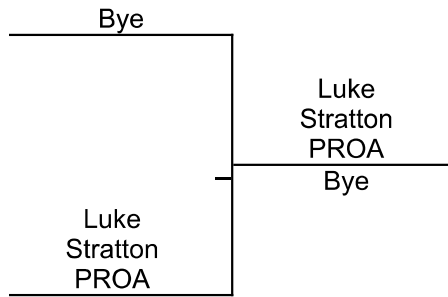

Round 3

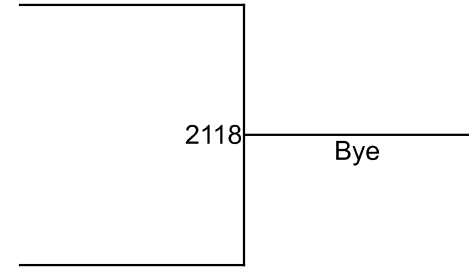

L. Stratton (PROA)
1ST

Bye
2ND

2023 OAC Lakota West GS District

Division IV 65

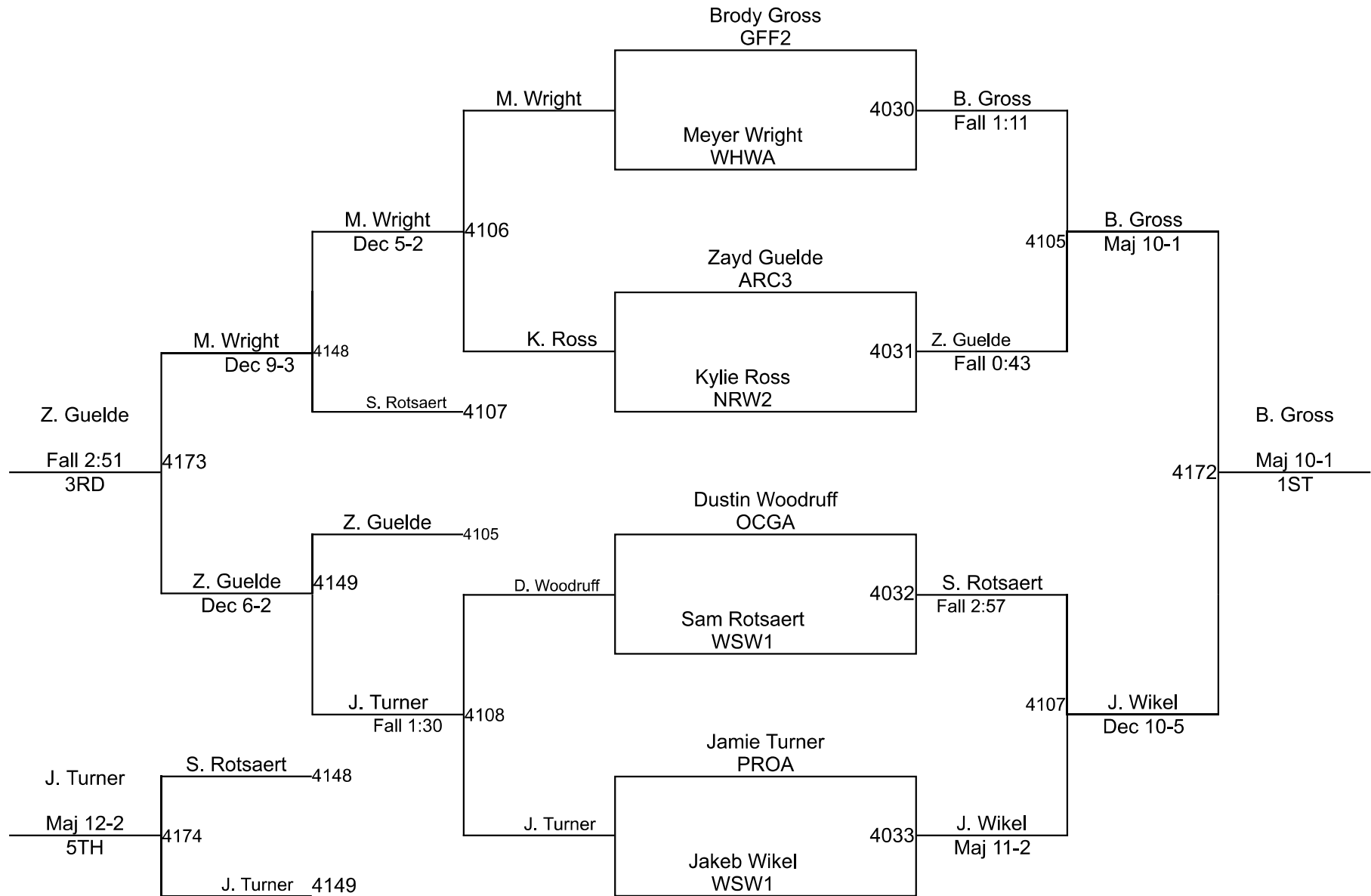

2023 OAC Lakota West GS District

Division IV 70

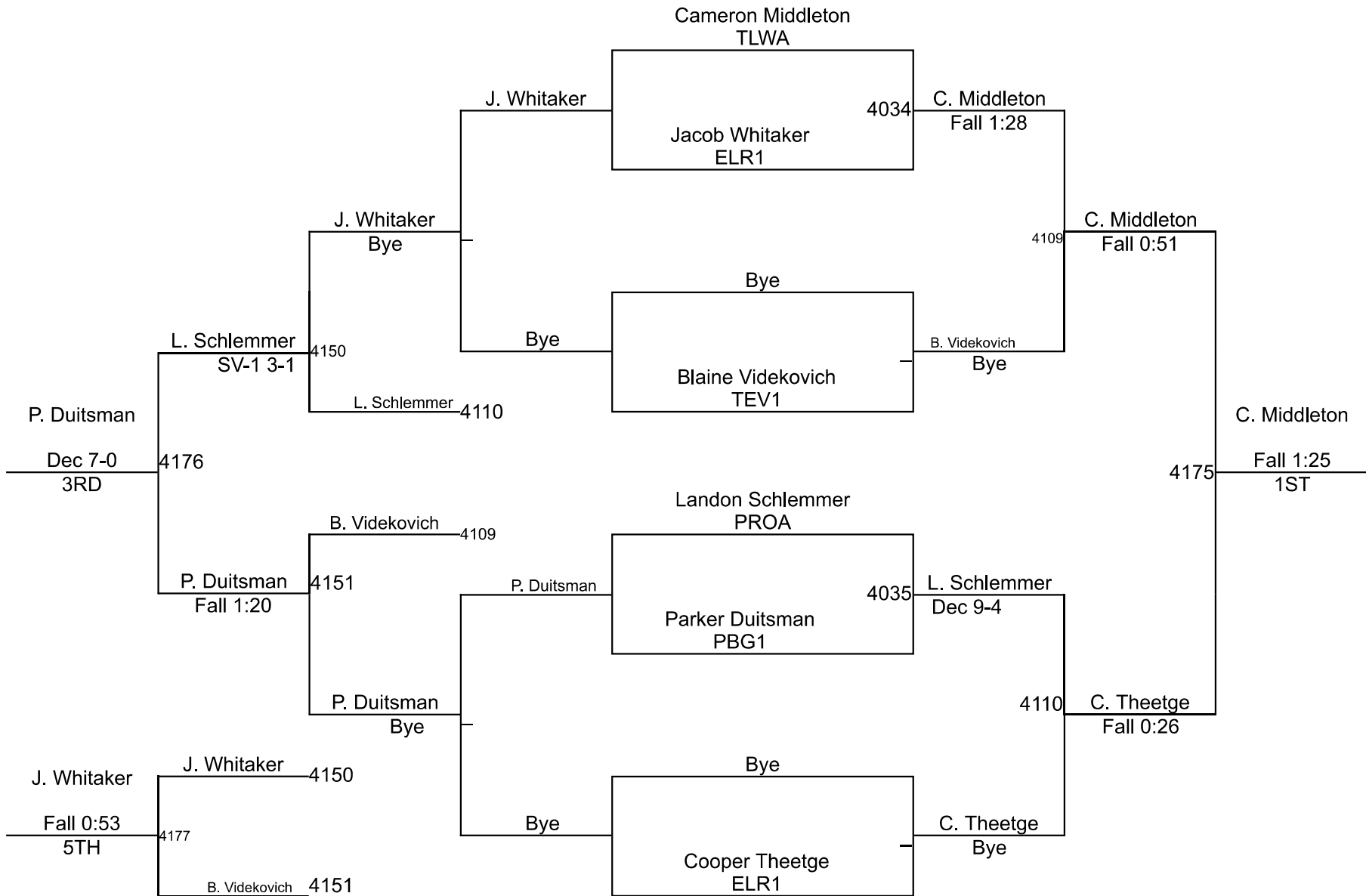

2023 OAC Lakota West GS District

Division IV 75

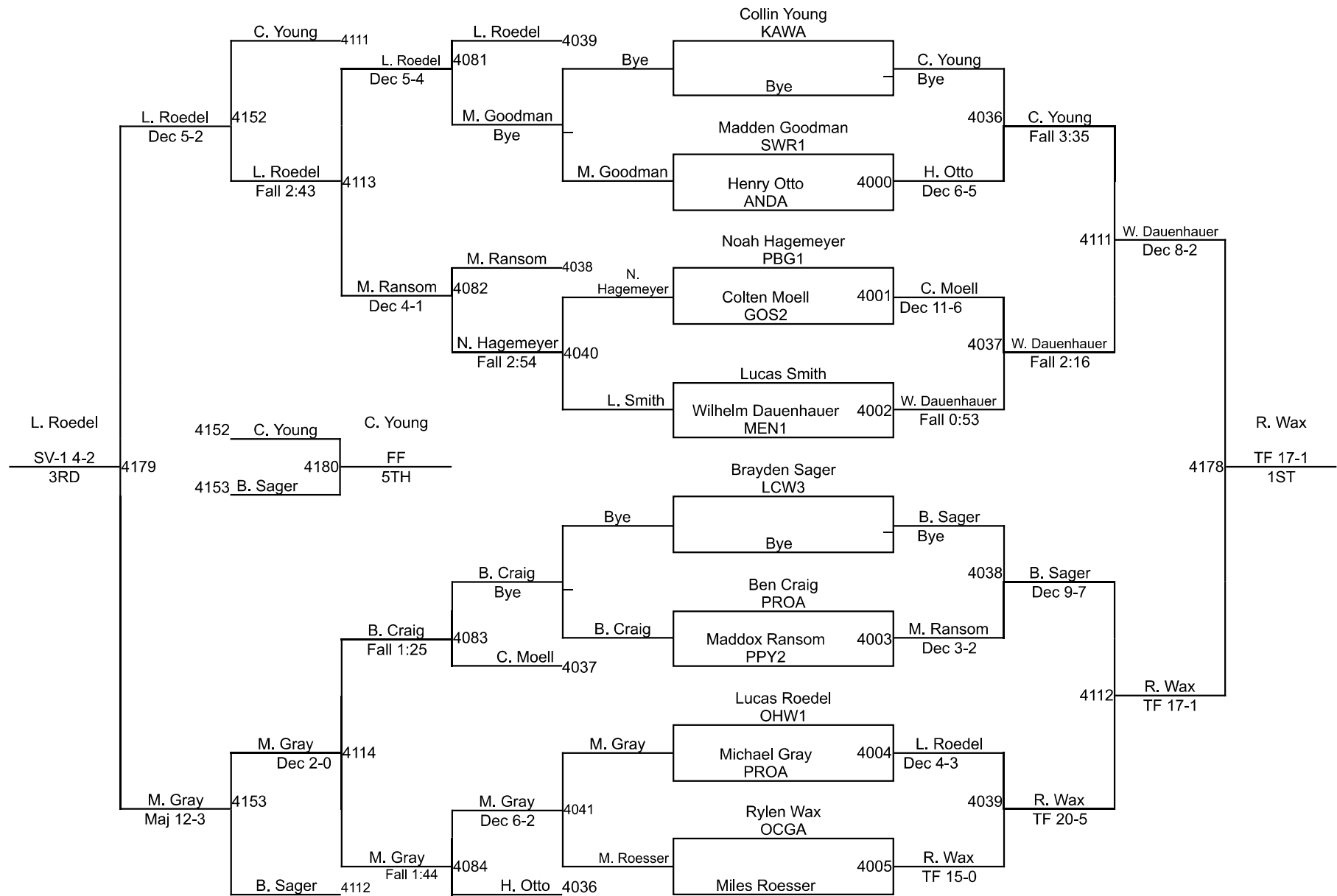

2023 OAC Lakota West GS District

Division IV 80

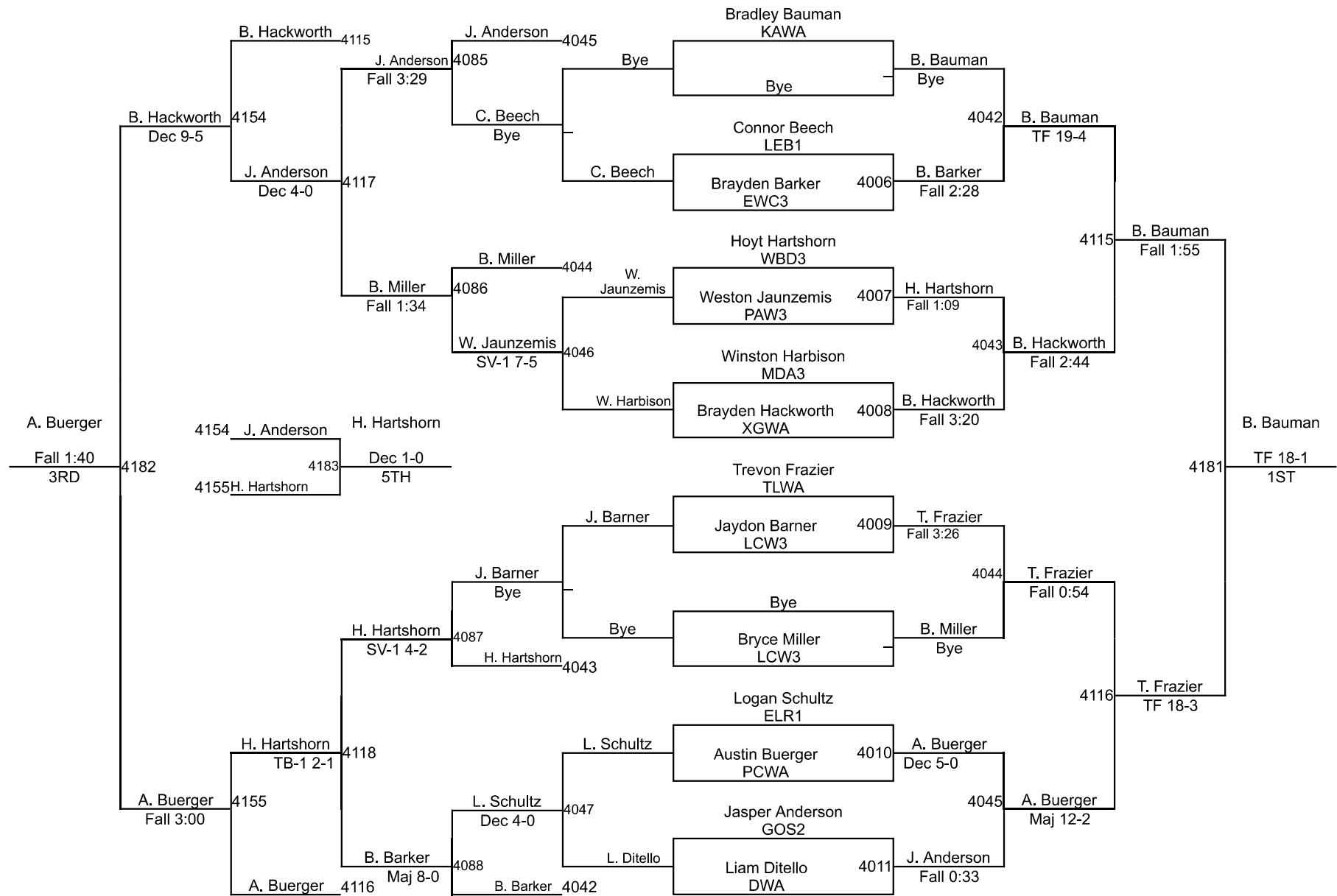

2023 OAC Lakota West GS District

Division IV 85

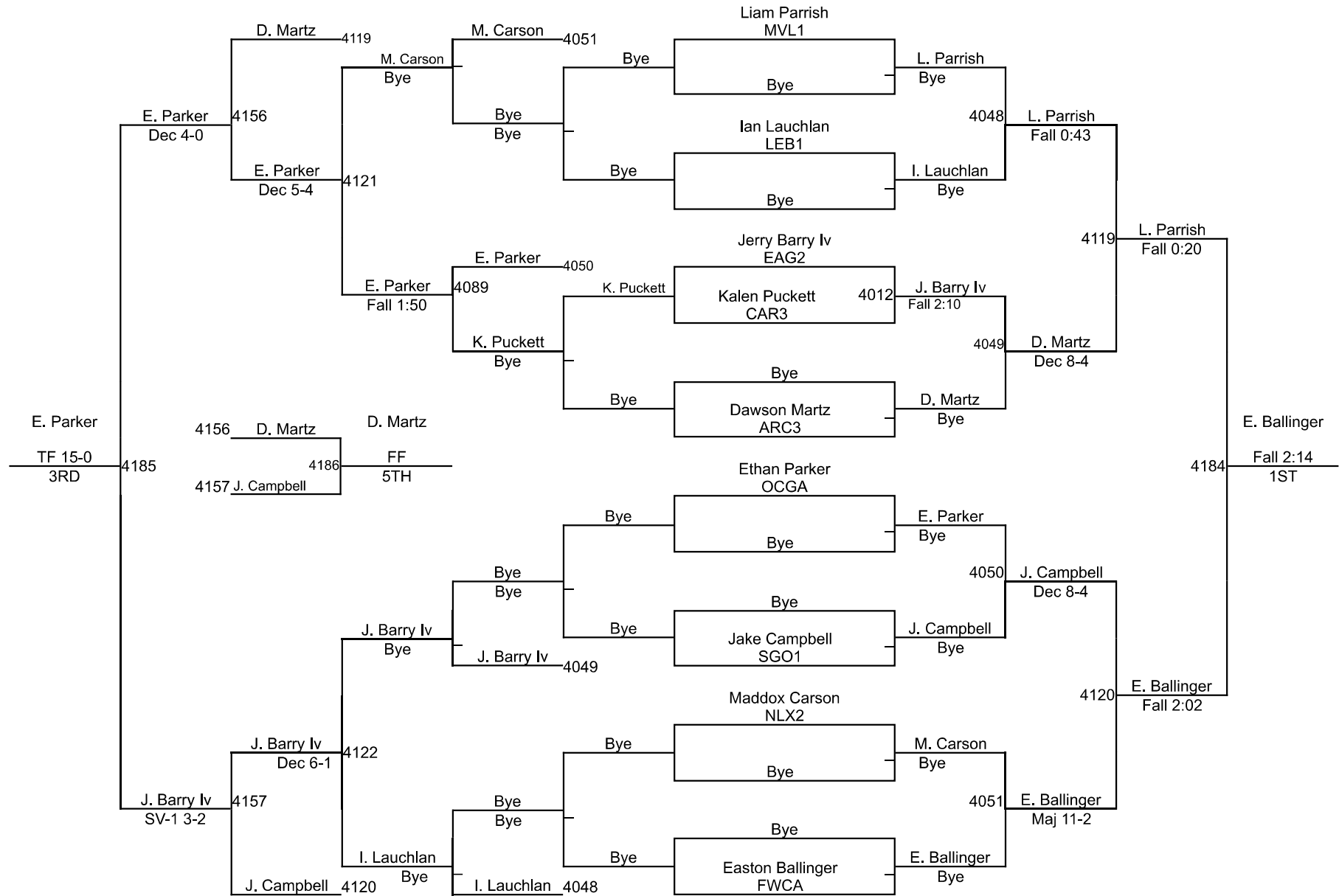

2023 OAC Lakota West GS District

Division IV 90

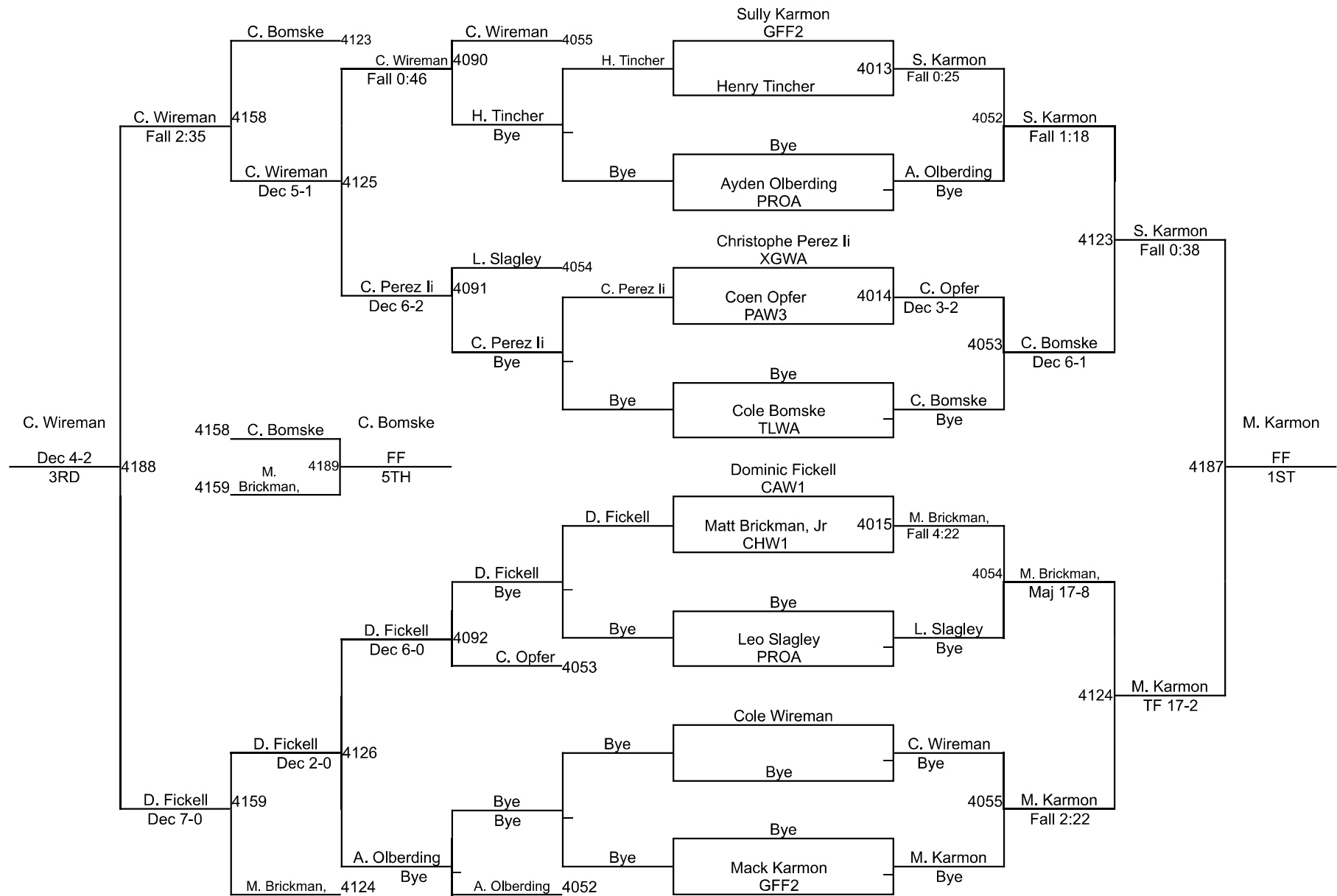

2023 OAC Lakota West GS District

Division IV 95

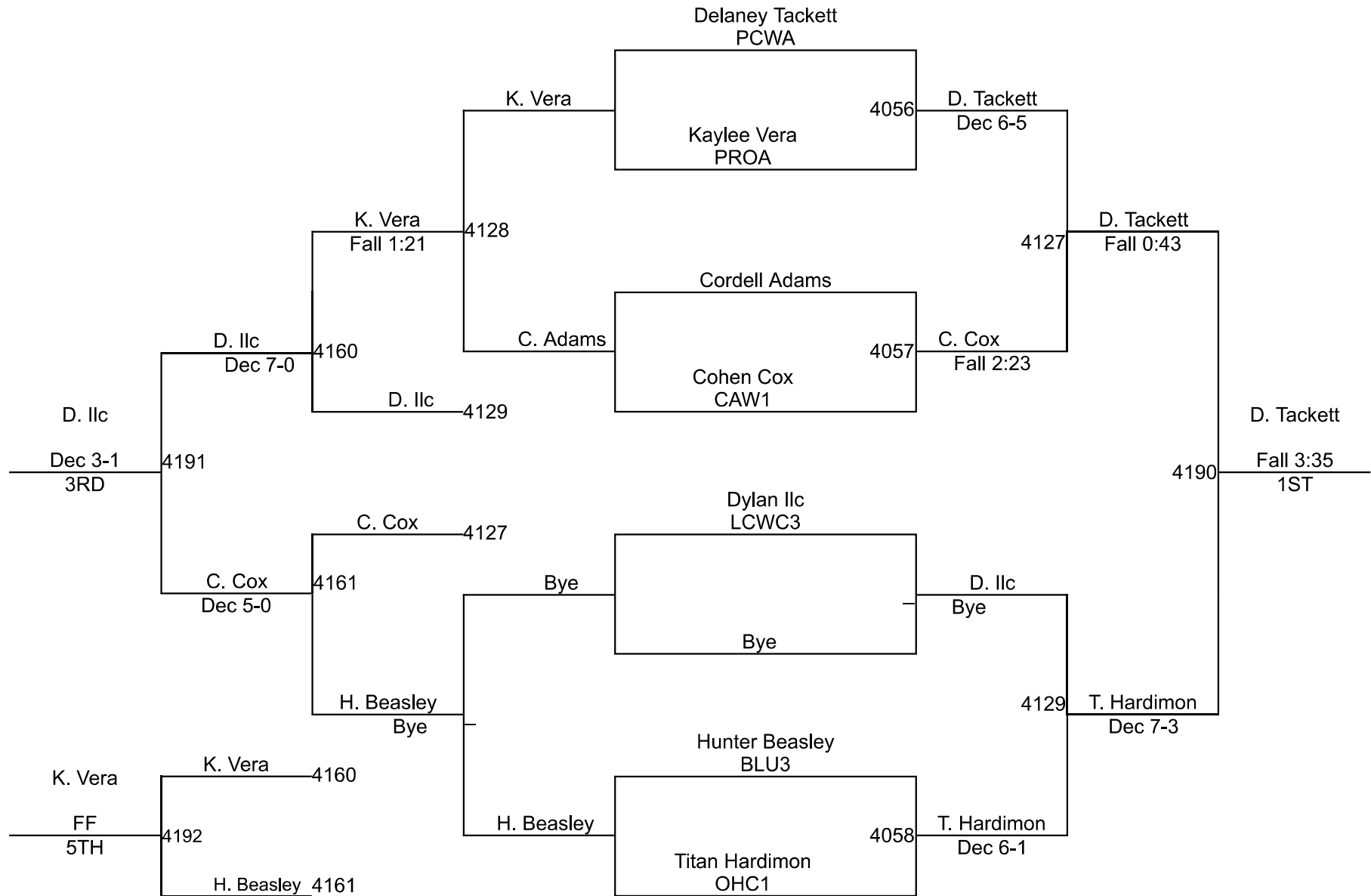

2023 OAC Lakota West GS District

Division IV 100

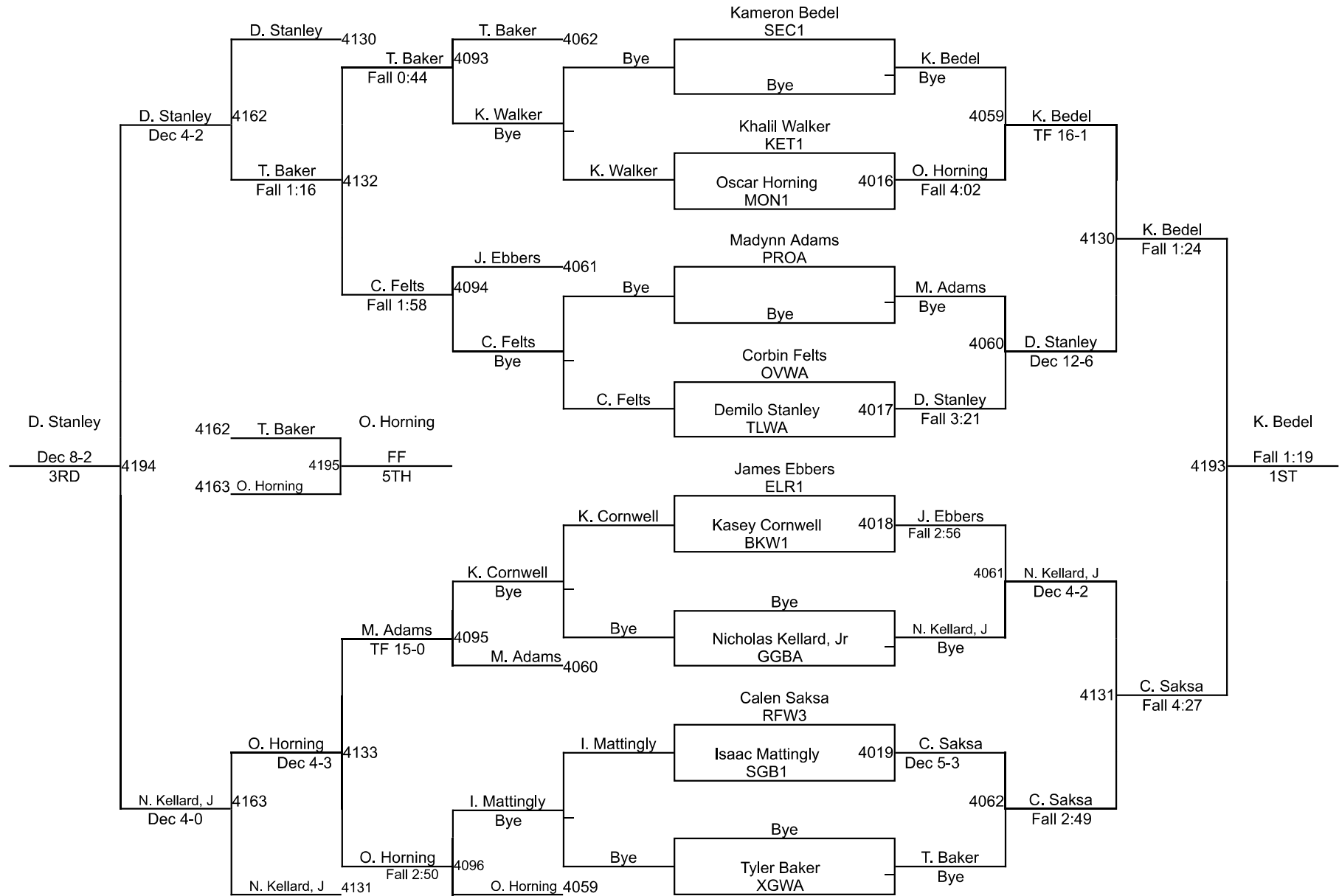

2023 OAC Lakota West GS District

Division IV 130

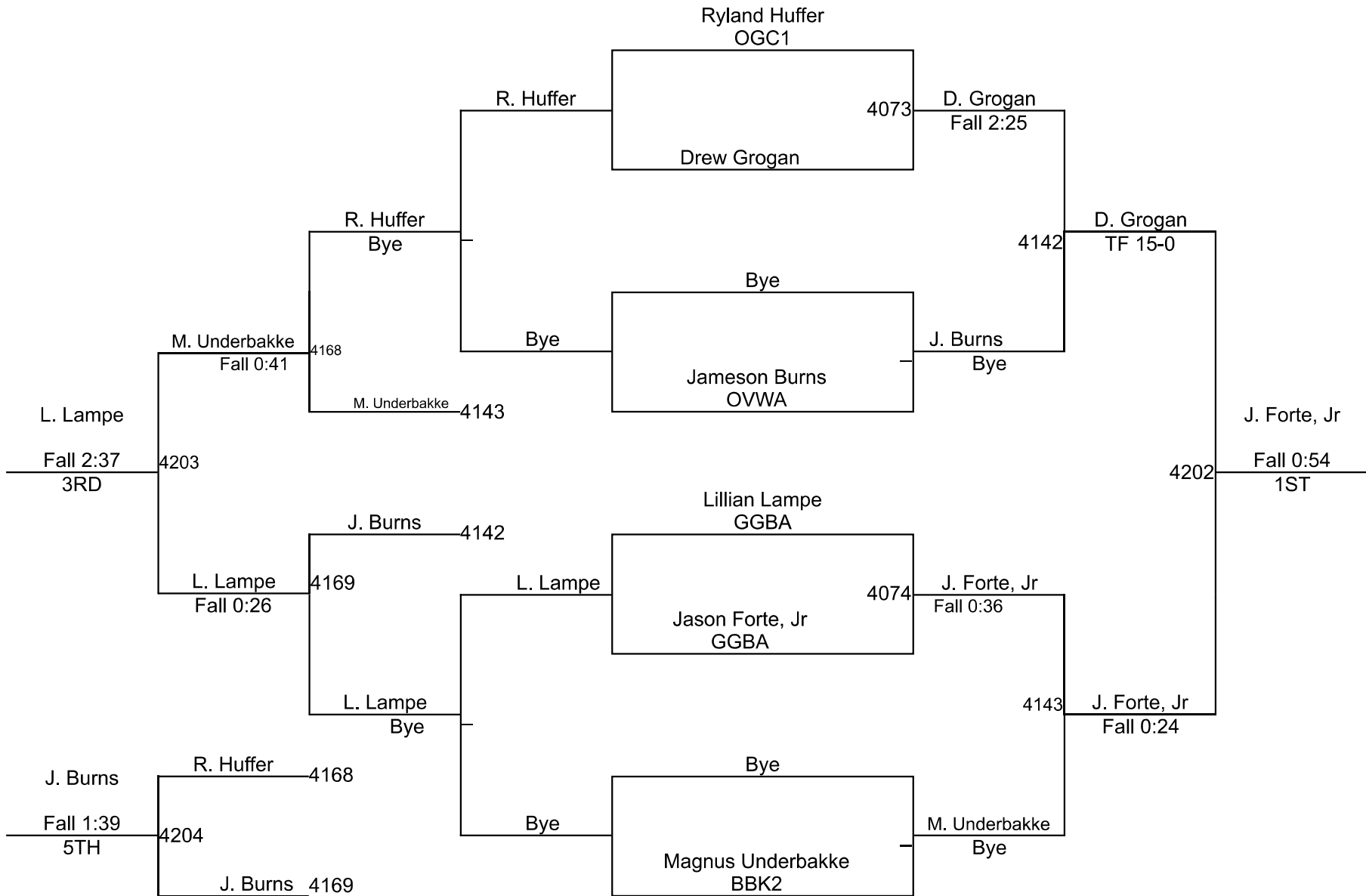

2023 OAC Lakota West GS District

Division IV 140

Round 1

Deklin O`Day DWA		Deklin O`Day DWA
Troy Dozois TLWA	4027	Fall 1:23

Josh Tener OVWA		Josh Tener OVWA
Jaxon Kokensparger HAR1	4028	Fall 0:30

Round 2

Deklin O`Day DWA		Deklin O`Day DWA
Jaxon Kokensparger HAR1	4075	Fall 2:00

Josh Tener OVWA		Troy Dozois TLWA
Troy Dozois TLWA	4076	Fall 0:37

Round 3

Deklin O`Day DWA		Deklin O`Day DWA
Josh Tener OVWA	4102	Fall 1:03

Jaxon Kokensparger HAR1		Troy Dozois TLWA
Troy Dozois TLWA	4103	Fall 2:47

WRESTLERS

D. O`Day (DWA)

T. Dozois (TLWA)

J. Tener (OVWA)

J. Kokensparger (HAR1)

D. O`Day (DWA)

1ST

T. Dozois (TLWA)

2ND

J. Tener (OVWA)

3RD

J. Kokensparger (HAR1)

4TH

2023 OAC Lakota West GS District

Division IV 180

