

Oak Harbor Rocket Open

Division 1 Novice 40 Novice

Round 1

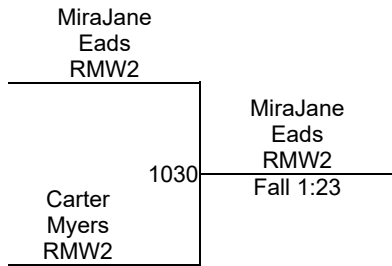

Round 2

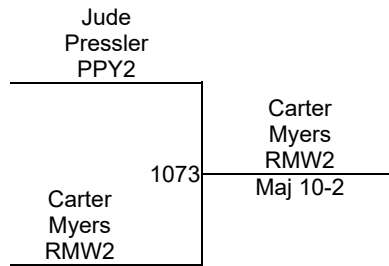

Round 3

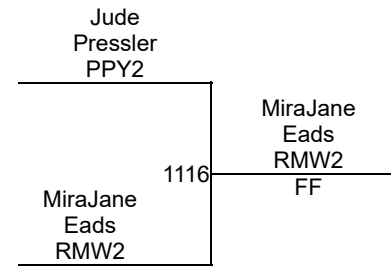

M. Eads (RMW2)
1ST

C. Myers (RMW2)
2ND

J. Pressler (PPY2)
3RD

Oak Harbor Rocket Open

Division 1 Novice 45 Novice

Round 1

Owen Johnson		Owen Johnson
Kane Johson	1018	Fall 2:39
Sandusky Lions		

Leo Zenowicz		Abel Workman
Abel Workman	1019	Fall 0:25

S. Dodson ()
1ST

Round 2

Saphyra Dodson		Saphyra Dodson
Abel Workman	1039	Dec 6-5

Owen Johnson		Owen Johnson
Leo Zenowicz	1040	Fall 0:56

O. Johnson ()
2ND

Round 3

Saphyra Dodson		Saphyra Dodson
Leo Zenowicz	1078	TF 15-0

Kane Johson		Abel Workman
Sandusky Lions		Fall 1:42
Abel Workman	1079	

A. Workman ()
3RD

Round 4

Saphyra Dodson		Saphyra Dodson
Kane Johson	1100	Fall 1:11
Sandusky Lions		

Owen Johnson		Owen Johnson
Abel Workman	1101	Dec 5-4

L. Zenowicz ()
4TH

Round 5

Saphyra Dodson		Saphyra Dodson
Owen Johnson	1139	Maj 13-0

Kane Johson		Leo Zenowicz
Sandusky Lions		FF
Leo Zenowicz	1140	

K. Johson (Sandusky Lions)
5TH

Oak Harbor Rocket Open

Division 1 Novice 48 Novice

Round 1

Round 2

Round 3

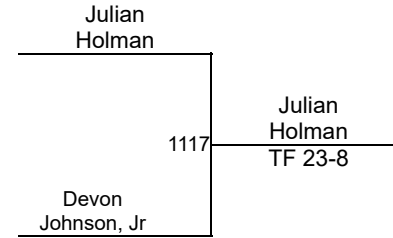
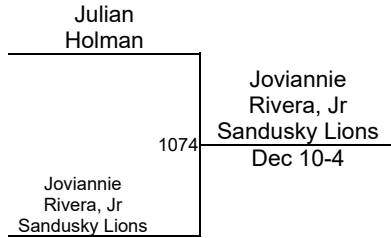
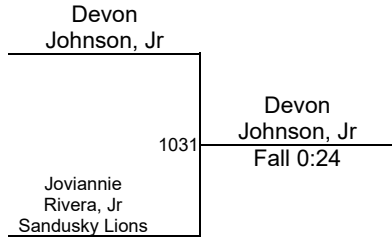

 D. Johnson, Jr ()
1ST

 J. Holman ()
2ND

 J. Rivera, Jr (Sandusky Lions)
3RD

Oak Harbor Rocket Open

Division 1 Novice 55 Novice

Round 1

O. Grimm		L. Patton,JR
L. Patton,JR	1000	TF 22-7

B. Leber		B. Schaffer
B. Schaffer	1001	Fall 1:47

B. Case		D. Rosemond
D. Rosemond	1002	Fall 2:38

Round 2

O. Grimm		D. Rosemond
D. Rosemond	1043	Fall 1:26

B. Leber		B. Case
B. Case	1044	Fall 1:47

B. Schaffer		L. Patton,JR
L. Patton,JR	1045	TF 16-1

Round 3

O. Grimm		O. Grimm
B. Case	1082	Dec 10-8

B. Leber		L. Patton,JR
L. Patton,JR	1083	TF 16-1

B. Schaffer		D. Rosemond
D. Rosemond	1084	Maj 16-7

Round 4

O. Grimm		O. Grimm
B. Schaffer	1121	Dec 14-9

B. Leber		D. Rosemond
D. Rosemond	1122	TF 15-0

B. Case		L. Patton,JR
L. Patton,JR	1123	TF 16-1

Round 5

O. Grimm		O. Grimm
B. Leber	1143	Fall 1:33

B. Schaffer		B. Schaffer
B. Case	1144	Fall 0:16

D. Rosemond		L. Patton,JR
L. Patton,JR	1145	Maj 14-5

- | |
|-------------------------|
| Lavar Patton,JR () |
| 1ST |
| Dominic Rosemond (POC2) |
| 2ND |
| Owen Grimm (WSW1) |
| 3RD |
| Bronsyn Schaffer (SEN3) |
| 4TH |
| Briggs Case () |
| 5TH |
| Barrett Leber (EWC3) |
| 6TH |

Oak Harbor Rocket Open

Division 1 Novice 60 Novice

Round 1

Round 2

Round 3

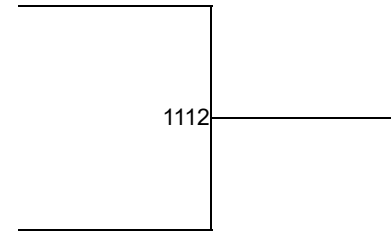
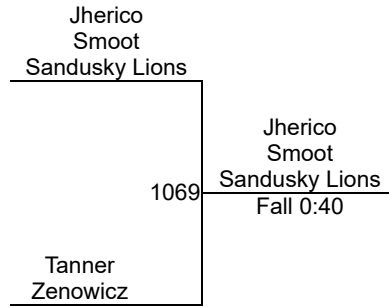
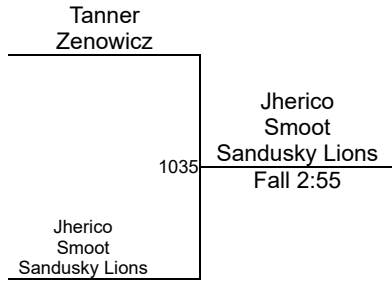

J. Smoot (Sandusky Lions)
1ST

T. Zenowicz ()
2ND

Oak Harbor Rocket Open

Division 2 Novice 51 Novice

Round 1

C. Fitchpatrick	1003	C. Fitchpatrick
N. Reinbolt		TF 15-0

W. Franks	1004	W. Franks
H. Whalen		Fall 0:56

C. Hernandez	1005	C. Hernandez
W. West		Fall 0:46

Round 2

C. Fitchpatrick	1046	C. Fitchpatrick
W. West		Fall 0:35

W. Franks	1047	C. Hernandez
C. Hernandez		TF 17-2

H. Whalen	1048	N. Reinbolt
N. Reinbolt		Fall 0:11

Round 3

C. Fitchpatrick	1085	C. Fitchpatrick
C. Hernandez		Fall 1:31

W. Franks	1086	N. Reinbolt
N. Reinbolt		Fall 2:45

H. Whalen	1087	H. Whalen
W. West		Dec 11-8

Round 4

C. Fitchpatrick	1124	C. Fitchpatrick
H. Whalen		Fall 0:21

W. Franks	1125	W. West
W. West		Dec 6-4

C. Hernandez	1126	C. Hernandez
N. Reinbolt		Dec 7-2

Round 5

C. Fitchpatrick	1146	C. Fitchpatrick
W. Franks		Fall 0:35

H. Whalen	1147	C. Hernandez
C. Hernandez		Fall 0:50

W. West	1148	W. West
N. Reinbolt		Dec 10-8

- _____
Charlie Fitchpatrick ()
1ST
- _____
Creighton Hernandez (BTWA)
2ND
- _____
Wyatt West (FDMA)
3RD
- _____
Nolan Reinbolt ()
4TH
- _____
Wyatt Franks (POC2)
5TH
- _____
Hudson Whalen (EWC3)
6TH

Oak Harbor Rocket Open

Division 2 Novice 55 Novice

Round 1

L. Morris	Z. Dickerson
Z. Dickerson 1006	TF 15-0

E. Limberios	J. Turner
J. Turner 1007	Fall 1:27

C. Colwell	C. Colwell
C. Welch 1008	Fall 1:34

Round 2

L. Morris	C. Welch
C. Welch 1049	TF 17-2

E. Limberios	C. Colwell
C. Colwell 1050	Fall 0:35

J. Turner	Z. Dickerson
Z. Dickerson 1051	Dec 10-5

Round 3

L. Morris	C. Colwell
C. Colwell 1088	TF 15-0

E. Limberios	Z. Dickerson
Z. Dickerson 1089	Dec 6-3

J. Turner	C. Welch
C. Welch 1090	Fall 0:51

Round 4

L. Morris	L. Morris
J. Turner 1127	FF

E. Limberios	C. Welch
C. Welch 1128	Dec 8-3

C. Colwell	C. Colwell
Z. Dickerson 1129	Fall 0:42

Round 5

L. Morris	E. Limberios
E. Limberios 1149	Dec 12-7

J. Turner	C. Colwell
C. Colwell 1150	FF

C. Welch	Z. Dickerson
Z. Dickerson 1151	Fall 2:31

Carson Colwell (PPC2)

1ST

Zander Dickerson (Sandusky Lions)

2ND

Cordin Welch ()

3RD

Logan Morris ()

4TH

Jus Turner ()

5TH

Eli Limberios (EWC3)

6TH

Oak Harbor Rocket Open

Division 2 Novice 58 Novice

Round 1

BrantLee Myerholtz		Ka`von Herrin Sandusky Lions	
Ka`von Herrin Sandusky Lions	1022	TF 15-0	
X`zayvian Hunter Sandusky Lions		Joshua Mcneeley WSW1	
Joshua Mcneeley WSW1	1023	Dec 6-2	

Round 2

BrantLee Myerholtz		Joshua Mcneeley WSW1	
Joshua Mcneeley WSW1	1061	Fall 1:21	
X`zayvian Hunter Sandusky Lions		Ka`von Herrin Sandusky Lions	
Ka`von Herrin Sandusky Lions	1062	Maj 13-2	

Round 3

BrantLee Myerholtz		X`zayvian Hunter Sandusky Lions	
X`zayvian Hunter Sandusky Lions	1104	Fall 0:45	
Joshua Mcneeley WSW1		Ka`von Herrin Sandusky Lions	
Ka`von Herrin Sandusky Lions	1105	TF 15-0	

WRESTLERS

B. Myerholtz ()

K. Herrin (Sandusky Lions)

X. Hunter (Sandusky Lions)

J. Mcneeley (WSW1)

K. Herrin (Sandusky Lions)

1ST

J. Mcneeley (WSW1)

2ND

X. Hunter (Sandusky Lions)

3RD

B. Myerholtz ()

4TH

Oak Harbor Rocket Open

Division 2 Novice 67 Novice

Round 1

S. Highlander	1009	C. Hotz
C. Hotz		Fall 0:37

L. Jones	1010	L. Jones
C. Rose		Dec 8-2

G. Clark	1011	C. Fairall
C. Fairall		Dec 9-5

Round 2

S. Highlander	1052	S. Highlander
C. Fairall		Fall 2:00

L. Jones	1053	L. Jones
G. Clark		Fall 2:25

C. Rose	1054	C. Hotz
C. Hotz		Fall 1:51

Round 3

S. Highlander	1091	S. Highlander
G. Clark		Fall 2:25

L. Jones	1092	C. Hotz
C. Hotz		Dec 9-2

C. Rose	1093	C. Rose
C. Fairall		Maj 15-6

Round 4

S. Highlander	1130	C. Rose
C. Rose		Dec 11-9

L. Jones	1131	L. Jones
C. Fairall		Fall 2:57

G. Clark	1132	C. Hotz
C. Hotz		Fall 0:26

Round 5

S. Highlander	1152	L. Jones
L. Jones		Dec 8-2

C. Rose	1153	C. Rose
G. Clark		Fall 1:10

C. Fairall	1154	C. Hotz
C. Hotz		Fall 2:32

- Carson Hotz (POC2)
1ST

- Liam Jones (EWC3)
2ND

- Cameron Rose (RMW2)
3RD

- Sam Highlander ()
4TH

- Chase Fairall (GEN3)
5TH

- George Clark (EWC3)
6TH

Oak Harbor Rocket Open

Division 2 Novice 70 Novice

Round 1

M. Maurow		M. Maurow
K. Williams Walk	1012	Fall 2:53

L. Szych		L. Szych
L. Giebel	1013	Fall 0:18

E. Swartz		E. Swartz
B. Grimm	1014	Fall 2:50

Round 2

M. Maurow		M. Maurow
B. Grimm	1055	Fall 0:41

L. Szych		L. Szych
E. Swartz	1056	Fall 0:39

L. Giebel		K. Williams Walk
K. Williams Walk	1057	Fall 1:11

Round 3

M. Maurow		M. Maurow
E. Swartz	1094	Fall 1:49

L. Szych		L. Szych
K. Williams Walk	1095	Fall 0:29

L. Giebel		L. Giebel
B. Grimm	1096	Fall 2:58

Round 4

M. Maurow		M. Maurow
L. Giebel	1133	Fall 0:20

L. Szych		L. Szych
B. Grimm	1134	Fall 1:18

E. Swartz		K. Williams Walk
K. Williams Walk	1135	Fall 1:59

Round 5

M. Maurow		L. Szych
L. Szych	1155	TF 15-0

L. Giebel		E. Swartz
E. Swartz	1156	Fall 0:31

B. Grimm		K. Williams Walk
K. Williams Walk	1157	Fall 0:51

- Lucas Szych (GEN3)
1ST
- Maverick Maurow (EWC3)
2ND
- Kahill Williams Walk (Sandusky Lions)
3RD
- Evan Swartz (RMW2)
4TH
- LeRae Giebel (FDMA)
5TH
- Benjamin Grimm (WSW1)
6TH

Oak Harbor Rocket Open

Division 2 Novice 75 Novice

Round 1

B. Baumgartner		B. Baumgartner
B. Bergman	1015	Fall 1:58

A. Buehler		A. Verkin
A. Verkin	1016	Fall 0:32

C. Smith		C. Smith
G. Yamanouchi	1017	Dec 14-11

Round 2

B. Baumgartner		B. Baumgartner
G. Yamanouchi	1058	Fall 0:40

A. Buehler		A. Buehler
C. Smith	1059	TF 16-1

A. Verkin		A. Verkin
B. Bergman	1060	Fall 0:50

Round 3

B. Baumgartner		B. Baumgartner
C. Smith	1097	Fall 0:51

A. Buehler		B. Bergman
B. Bergman	1098	Fall 2:59

A. Verkin		A. Verkin
G. Yamanouchi	1099	Fall 0:43

Round 4

B. Baumgartner		B. Baumgartner
A. Verkin	1136	Fall 0:28

A. Buehler		G. Yamanouchi
G. Yamanouchi	1137	Fall 1:27

C. Smith		B. Bergman
B. Bergman	1138	Fall 0:43

Round 5

B. Baumgartner		B. Baumgartner
A. Buehler	1158	Fall 0:18

A. Verkin		A. Verkin
C. Smith	1159	Fall 0:51

G. Yamanouchi		B. Bergman
B. Bergman	1160	Fall 1:26

Bowen Baumgartner ()

1ST

Adam Verkin (POC2)

2ND

Bo Bergman (GEN3)

3RD

Gage Yamanouchi (EWC3)

4TH

Adam Buehler (GEN3)

5TH

Cooper Smith (EWC3)

6TH

Oak Harbor Rocket Open

Division 2 Novice 85 Novice

Round 1

Camden Barker EWC3	Colton Petznick EWC3
Colton Petznick EWC3	1020
Fall 0:51	

Josiah Smoot Sandusky Lions	Josiah Smoot Sandusky Lions
Pierce McPherson GEN3	1021
Fall 0:14	

C. Petznick (EWC3)
1ST

Round 2

Cooper Perry	Cooper Perry
Pierce McPherson GEN3	1041
TF 15-0	

Camden Barker EWC3	Camden Barker EWC3
Josiah Smoot Sandusky Lions	1042
Dec 12-6	

J. Smoot (Sandusky Lions)
2ND

Round 3

Cooper Perry	Josiah Smoot Sandusky Lions
Josiah Smoot Sandusky Lions	1080
Fall 1:10	

Colton Petznick EWC3	Colton Petznick EWC3
Pierce McPherson GEN3	1081
Fall 0:20	

C. Perry ()
3RD

Round 4

Cooper Perry	Colton Petznick EWC3
Colton Petznick EWC3	1102
Fall 1:49	

Camden Barker EWC3	Pierce McPherson GEN3
Pierce McPherson GEN3	1103
Fall 2:54	

P. McPherson (GEN3)
4TH

Round 5

Cooper Perry	Cooper Perry
Camden Barker EWC3	1141
Dec 10-7	

Colton Petznick EWC3	Colton Petznick EWC3
Josiah Smoot Sandusky Lions	1142
Fall 1:15	

C. Barker (EWC3)
5TH

Oak Harbor Rocket Open

Division 2 Novice 110 Novice

Round 1

Toby Miller	1024	Davier Spearman Dec 4-0
Davier Spearman		
Zay Dickerson, Jr Sandusky Lions	1025	Zay Dickerson, Jr Sandusky Lions Fall 0:10
Ryan Harnisch POC2		

Round 2

Toby Miller	1063	Toby Miller Fall 0:11
Ryan Harnisch POC2		
Zay Dickerson, Jr Sandusky Lions	1064	Zay Dickerson, Jr Sandusky Lions Maj 14-5
Davier Spearman		

Round 3

Toby Miller	1106	Toby Miller Maj 11-1
Zay Dickerson, Jr Sandusky Lions		
Ryan Harnisch POC2	1107	Davier Spearman Dec 8-1
Davier Spearman		

WRESTLERS

- T. Miller ()
- D. Spearman ()
- Z. Dickerson, Jr (Sandusky Lions)
- R. Harnisch (POC2)

T. Miller ()	1ST
Z. Dickerson, Jr (Sandusky Lions)	2ND
D. Spearman ()	3RD
R. Harnisch (POC2)	4TH

Oak Harbor Rocket Open

Division 3 Novice 65 Novice

Round 1

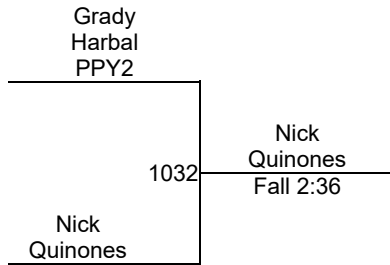

Round 2

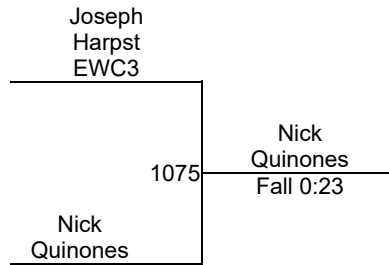

Round 3

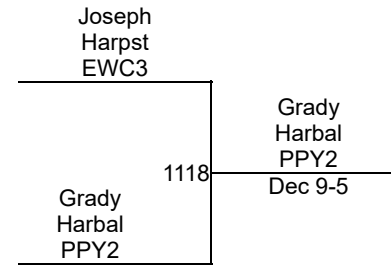

N. Quinones ()
1ST

G. Harbal (PPY2)
2ND

J. Harpst (EWC3)
3RD

Oak Harbor Rocket Open

Division 3 Novice 76 Novice

Round 1

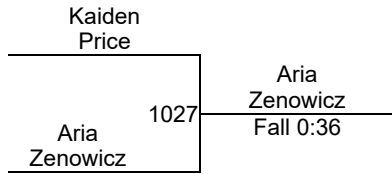
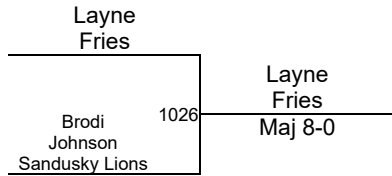

Round 2

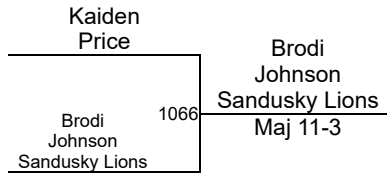
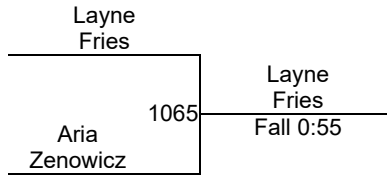

Round 3

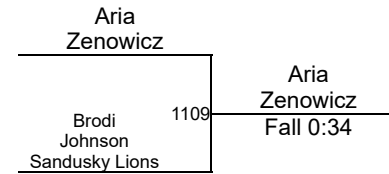
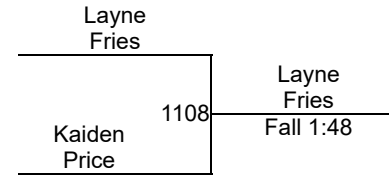

WRESTLERS

- L. Fries ()
- B. Johnson (Sandusky Lions)
- K. Price ()
- A. Zenowicz ()

L. Fries ()
1ST

A. Zenowicz ()
2ND

B. Johnson (Sandusky Lions)
3RD

K. Price ()
4TH

Oak Harbor Rocket Open

Division 3 Novice 110 Novice

Round 1

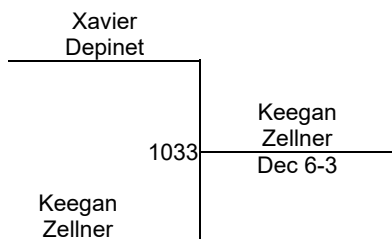

Round 2

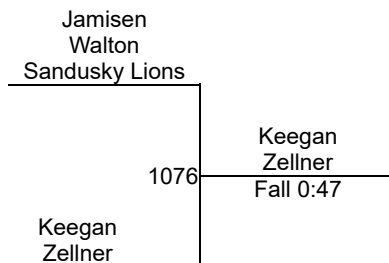

Round 3

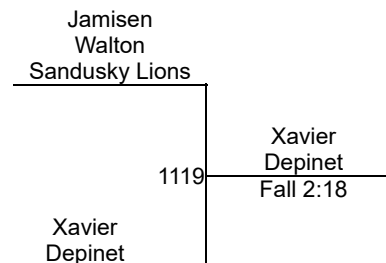

_____ K. Zellner ()
1ST

_____ X. Depinet ()
2ND

_____ J. Walton (Sandusky Lions)
3RD

Oak Harbor Rocket Open

Division 3 Novice 130 Novice

Round 1

Round 2

Round 3

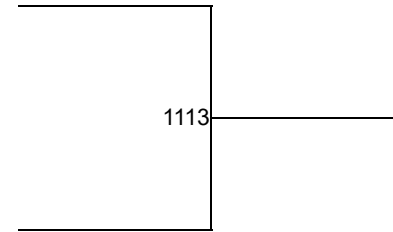
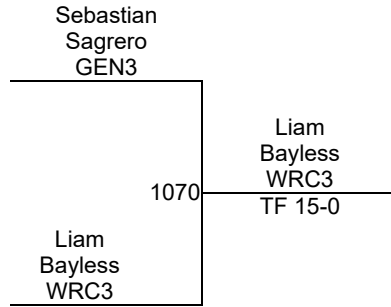
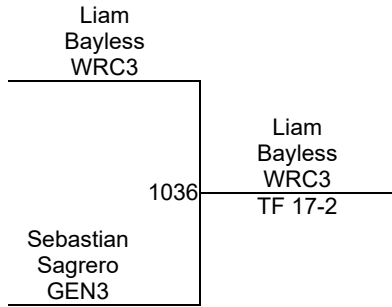

L. Bayless (WRC3)
1ST

S. Sagrero (GEN3)
2ND

Oak Harbor Rocket Open

Division 4 Novice 85 Novice

Round 1

Cody Franks POC2		Cody Franks POC2
Blake Harbal PPY2	1028	SV-1 6-4

Kaden Risch		K'saan Herrin Sandusky Lions
K'saan Herrin Sandusky Lions	1029	Dec 8-6

Round 2

Cody Franks POC2		K'saan Herrin Sandusky Lions
K'saan Herrin Sandusky Lions	1067	Dec 8-2

Kaden Risch		Kaden Risch Maj 8-0
Blake Harbal PPY2	1068	

Round 3

Cody Franks POC2		Kaden Risch
Kaden Risch	1110	Dec 6-4

K'saan Herrin Sandusky Lions		K'saan Herrin Sandusky Lions
Blake Harbal PPY2	1111	Dec 4-2

WRESTLERS

C. Franks (POC2)

B. Harbal (PPY2)

K. Risch ()

K. Herrin (Sandusky Lions)

K. Herrin (Sandusky Lions)

1ST

K. Risch ()

2ND

C. Franks (POC2)

3RD

B. Harbal (PPY2)

4TH

Oak Harbor Rocket Open

Division 4 Novice 100 Novice

Round 1

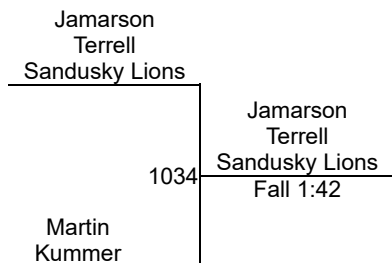

Round 2

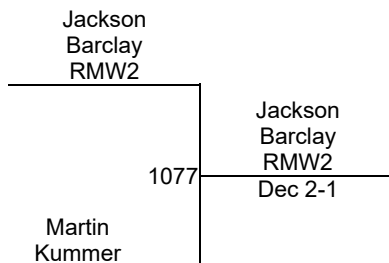

Round 3

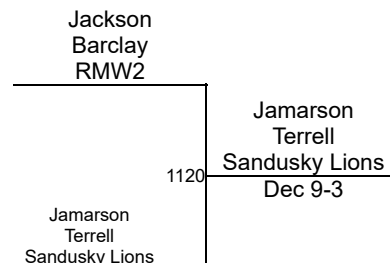

J. Terrell (Sandusky Lions)

1ST

J. Barclay (RMW2)

2ND

M. Kummer ()

3RD

Oak Harbor Rocket Open

Division 4 Novice 110 Novice

Round 1

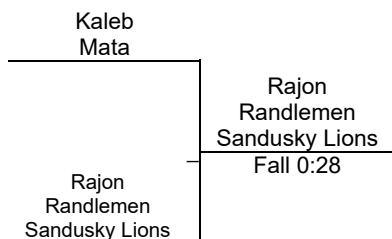

Round 2

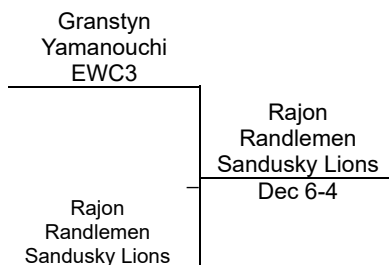

Round 3

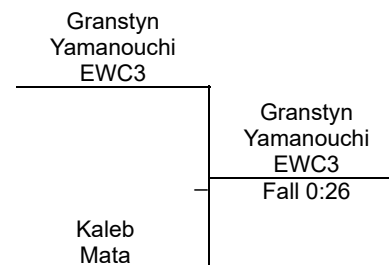

R. Randlemen (Sandusky Lions)
1ST

G. Yamanouchi (EWC3)
2ND

K. Mata ()
3RD

Oak Harbor Rocket Open

Division 4 Novice 180 Novice

Round 1

Round 2

Round 3

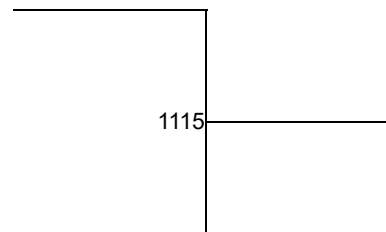
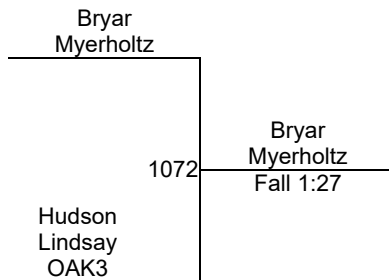
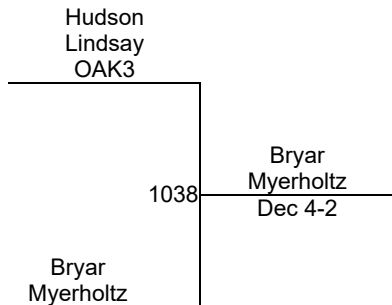

_____ B. Myerholtz ()
1ST

_____ H. Lindsay (OAK3)
2ND

Oak Harbor Rocket Open

Division 1 Open 45 Open

Round 1

Round 2

Round 3

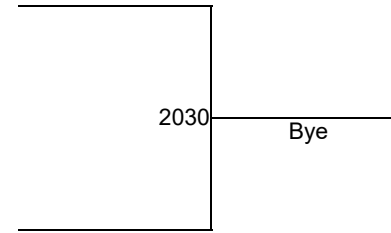
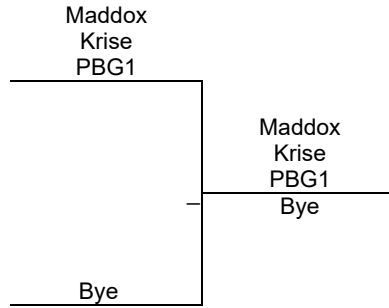
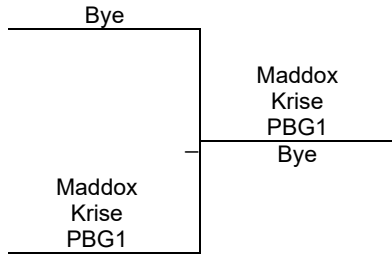

_____ M. Krise (PBG1)
1ST

_____ Bye
2ND

Oak Harbor Rocket Open

Division 2 Open 52 Open

Round 1

Gage Crawford HSWA	Miller Burdette EWO3 Dec 12-6
Miller Burdette EWO3	3000

Louie DeCaro PPY2	Louie DeCaro PPY2 TF 15-0
Maddox Krise	3001

Round 2

Gage Crawford HSWA	Gage Crawford HSWA Maj 12-1
Maddox Krise	3017

Louie DeCaro PPY2	Miller Burdette EWO3 Maj 9-0
Miller Burdette EWO3	3018

Round 3

Gage Crawford HSWA	Gage Crawford HSWA Dec 10-7
Louie DeCaro PPY2	3034

Maddox Krise	Miller Burdette EWO3 Maj 12-0
Miller Burdette EWO3	3035

WRESTLERS

G. Crawford (HSWA)

M. Burdette (EWO3)

L. DeCaro (PPY2)

M. Krise ()

M. Burdette (EWO3)

1ST

G. Crawford (HSWA)

2ND

L. DeCaro (PPY2)

3RD

M. Krise ()

4TH

Oak Harbor Rocket Open

Division 2 Open 55 Open

Round 1

Round 2

Round 3

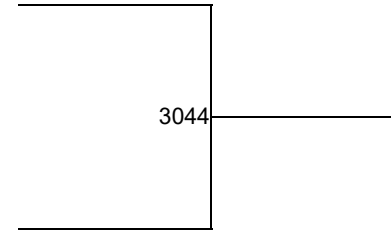
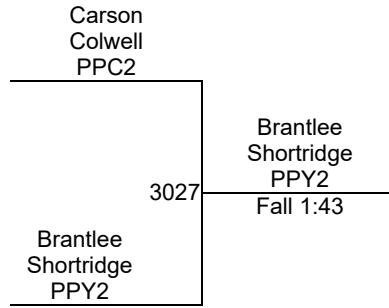
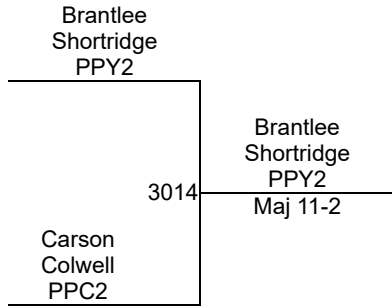

 B. Shortridge (PPY2)
1ST

 C. Colwell (PPC2)
2ND

Oak Harbor Rocket Open

Division 2 Open 73 Open

Round 1

Lincoln Crawford HSWA		Cooper Krise PBG1	
Cooper Krise PBG1	3002	Dec 6-0	

Adam Verkin POC2		Zach Shafer BGB2	
Zach Shafer BGB2	3003	Fall 0:56	

Round 2

Lincoln Crawford HSWA		Zach Shafer BGB2	
Zach Shafer BGB2	3019	Fall 1:48	

Adam Verkin POC2		Cooper Krise PBG1	
Cooper Krise PBG1	3020	Dec 6-0	

Round 3

Lincoln Crawford HSWA		Lincoln Crawford HSWA	
Adam Verkin POC2	3036	Dec 7-5	

Zach Shafer BGB2		Cooper Krise PBG1	
Cooper Krise PBG1	3037	TF 20-5	

WRESTLERS

L. Crawford (HSWA)

C. Krise (PBG1)

A. Verkin (POC2)

Z. Shafer (BGB2)

C. Krise (PBG1)

1ST

Z. Shafer (BGB2)

2ND

L. Crawford (HSWA)

3RD

A. Verkin (POC2)

4TH

Oak Harbor Rocket Open

Division 2 Open 100 Open

Round 1

Round 2

Round 3

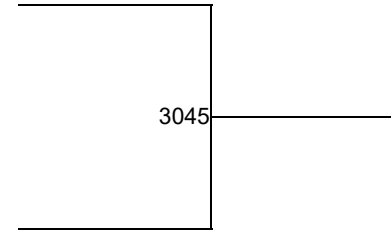
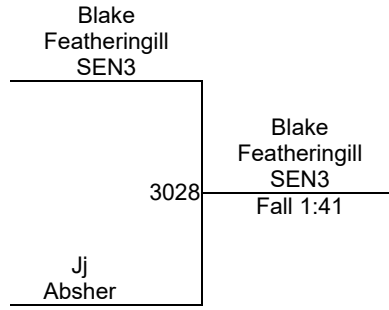
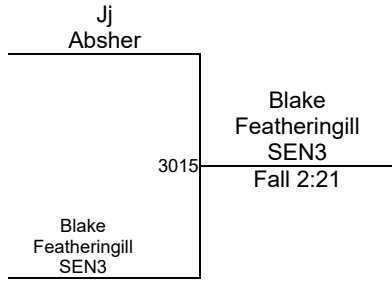

—————
 B. Featheringill (SEN3)
1ST

—————
 J. Absher ()
2ND

Oak Harbor Rocket Open

Division 3 Open 60 Open

Round 1

Mateo Mata GEN3	Karson Lee FDMA	
Karson Lee FDMA	2000	Maj 8-0

Beau Shortridge PPY2	Braxton Sharples BTWA	
Braxton Sharples BTWA	2001	Maj 14-1

B. Sharples (BTWA)
1ST

Round 2

Dylan West FDMA	Braxton Sharples BTWA	
Braxton Sharples BTWA	2009	Maj 10-0

Mateo Mata GEN3	Beau Shortridge PPY2	
Beau Shortridge PPY2	2010	SV-1 5-3

B. Shortridge (PPY2)
2ND

Round 3

Dylan West FDMA	Beau Shortridge PPY2	
Beau Shortridge PPY2	2018	Dec 9-2

Karson Lee FDMA	Braxton Sharples BTWA	
Braxton Sharples BTWA	2019	Maj 9-0

K. Lee (FDMA)
3RD

Round 4

Dylan West FDMA	Karson Lee FDMA	
Karson Lee FDMA	2022	Fall 1:47

Mateo Mata GEN3	Braxton Sharples BTWA	
Braxton Sharples BTWA	2023	TF 18-3

D. West (FDMA)
4TH

Round 5

Dylan West FDMA	Dylan West FDMA	
Mateo Mata GEN3	2033	Dec 4-0

Karson Lee FDMA	Beau Shortridge PPY2	
Beau Shortridge PPY2	2034	Maj 8-0

M. Mata (GEN3)
5TH

Oak Harbor Rocket Open

Division 3 Open 70 Open

Round 1

Carson Honeycutt SEN3	Conner Cornell POC2	2004	Maj 10-0
Conner Cornell POC2			

Ben Jordan WCWA	Ben Jordan WCWA	2005	SV-1 5-3
Parker Workman			

Round 2

Carson Honeycutt SEN3	Carson Honeycutt SEN3	2013	Dec 6-2
Parker Workman			

Ben Jordan WCWA	Ben Jordan WCWA	2014	Dec 4-0
Conner Cornell POC2			

Round 3

Carson Honeycutt SEN3	Ben Jordan WCWA	2026	Fall 1:00
Ben Jordan WCWA			

Parker Workman	Conner Cornell POC2	2027	Dec 3-2
Conner Cornell POC2			

WRESTLERS

C. Honeycutt (SEN3)

C. Cornell (POC2)

B. Jordan (WCWA)

P. Workman ()

B. Jordan (WCWA)

1ST

C. Cornell (POC2)

2ND

C. Honeycutt (SEN3)

3RD

P. Workman ()

4TH

Oak Harbor Rocket Open

Division 3 Open 77 Open

Round 1

Round 2

Round 3

Maverick Malott PPY2		Maverick Malott PPY2	
Brayden Barker EWC3	2006	Dec 7-0	

Maverick Malott PPY2		Nolan Hoffman PPY2	
Nolan Hoffman PPY2	2015	Fall 1:42	

Maverick Malott PPY2		Phoenix Peters WSW1	
Phoenix Peters WSW1	2028	Fall 0:56	

Phoenix Peters WSW1		Phoenix Peters WSW1	
Nolan Hoffman PPY2	2007	Dec 2-0	

Phoenix Peters WSW1		Phoenix Peters WSW1	
Brayden Barker EWC3	2016	Fall 1:47	

Nolan Hoffman PPY2		Nolan Hoffman PPY2	
Brayden Barker EWC3	2029	Maj 8-0	

WRESTLERS

M. Malott (PPY2)

B. Barker (EWC3)

P. Peters (WSW1)

N. Hoffman (PPY2)

P. Peters (WSW1)

1ST

N. Hoffman (PPY2)

2ND

M. Malott (PPY2)

3RD

B. Barker (EWC3)

4TH

Oak Harbor Rocket Open

Division 3 Open 85 Open

Round 1

Round 2

Round 3

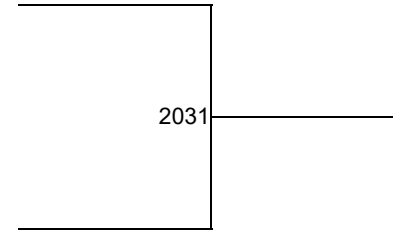
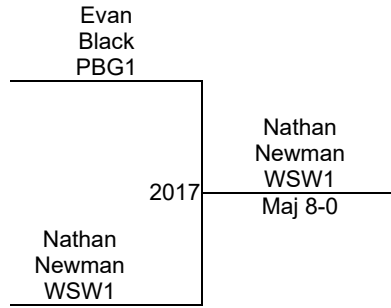
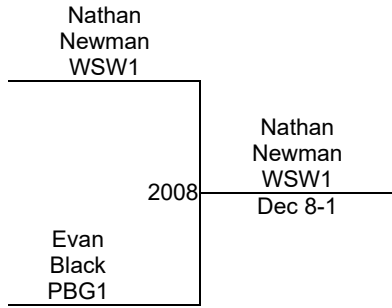

N. Newman (WSW1)

1ST

E. Black (PBG1)

2ND

Oak Harbor Rocket Open

Division 3 Open 95 Open

Round 1

Stran Schimmel HSWA	Stran Schimmel HSWA
Austin Purdy 2002	Dec 7-2

Ethan Briggs OAK3	Blake Depinet SEN3
Blake Depinet SEN3 2003	Fall 0:34

B. Depinet (SEN3)
1ST

Round 2

Austin Quillen EWC3	Blake Depinet SEN3
Blake Depinet SEN3 2011	Fall 2:23

Stran Schimmel HSWA	Stran Schimmel HSWA
Ethan Briggs OAK3 2012	Fall 1:28

S. Schimmel (HSWA)
2ND

Round 3

Austin Quillen EWC3	Ethan Briggs OAK3
Ethan Briggs OAK3 2020	Fall 0:28

Austin Purdy	Blake Depinet SEN3
Blake Depinet SEN3 2021	Dec 6-0

A. Purdy ()
3RD

Round 4

Austin Quillen EWC3	Austin Purdy
Austin Purdy 2024	Fall 1:52

Stran Schimmel HSWA	Blake Depinet SEN3
Blake Depinet SEN3 2025	Fall 1:45

E. Briggs (OAK3)
4TH

Round 5

Austin Quillen EWC3	Stran Schimmel HSWA
Stran Schimmel HSWA 2035	Fall 1:26

Austin Purdy	Austin Purdy
Ethan Briggs OAK3 2036	Fall 0:26

A. Quillen (EWC3)
5TH

Oak Harbor Rocket Open

Division 3 Open 160 Open

Round 1

Round 2

Round 3

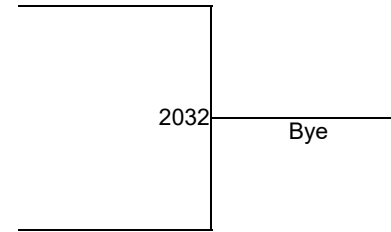
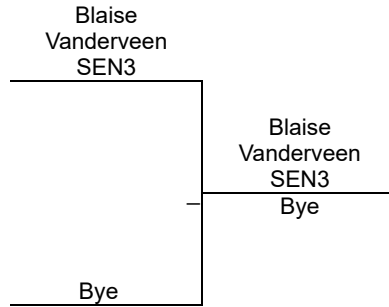
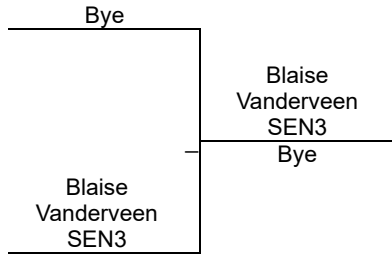

B. Vanderveen (SEN3)

1ST

Bye

2ND

Oak Harbor Rocket Open

Division 4 Open 73 Open

Round 1

Round 2

Round 3

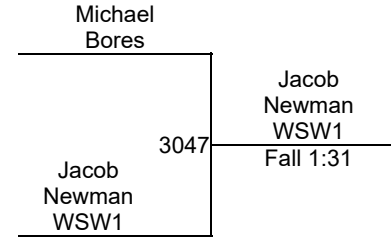
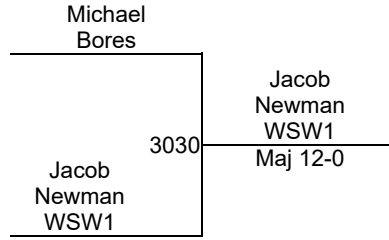
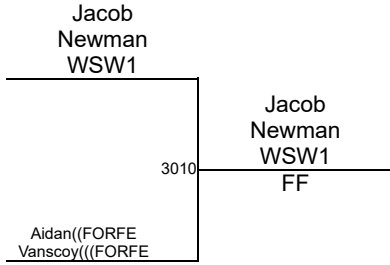

 J. Newman (WSW1)
1ST

 A. Vanscoy(((FORFE ()
2ND

 M. Bores ()
3RD

Oak Harbor Rocket Open

Division 4 Open 80 Open

Round 1

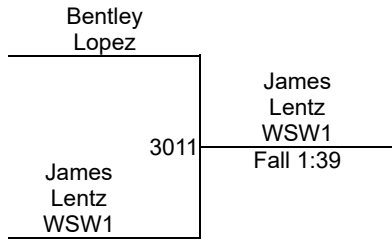

Round 2

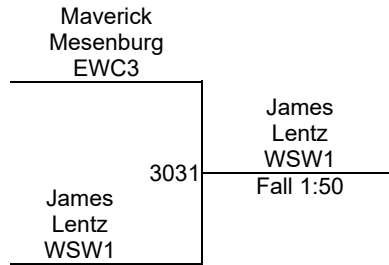

Round 3

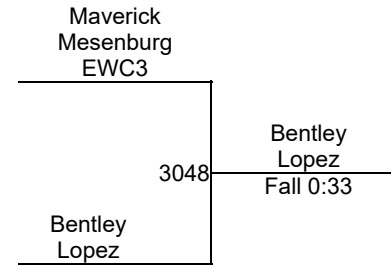

J. Lentz (WSW1)
1ST

B. Lopez ()
2ND

M. Mesenburg (EWC3)
3RD

Oak Harbor Rocket Open

Division 4 Open 85 Open

Round 1

William Cooper	Jackson Durbin HSWA
Jackson Durbin HSWA 3004	Fall 0:43

Trey Kromer PPY2	Nathan Newman WSW1
Nathan Newman WSW1 3005	Fall 1:40

Round 2

William Cooper	Nathan Newman WSW1
Nathan Newman WSW1 3021	Fall 0:34

Trey Kromer PPY2	Jackson Durbin HSWA
Jackson Durbin HSWA 3022	Fall 0:49

Round 3

William Cooper	Trey Kromer PPY2
Trey Kromer PPY2 3038	Fall 1:43

Nathan Newman WSW1	Nathan Newman WSW1
Jackson Durbin HSWA 3039	Dec 6-0

WRESTLERS

- W. Cooper ()
- J. Durbin (HSWA)
- T. Kromer (PPY2)
- N. Newman (WSW1)

N. Newman (WSW1)
1ST

J. Durbin (HSWA)
2ND

T. Kromer (PPY2)
3RD

W. Cooper ()
4TH

Oak Harbor Rocket Open

Division 4 Open 90 Open

Round 1

Jaron Depinet SEN3		Meredith Greenslade HSWA	
Meredith Greenslade HSWA	3006	Dec 12-6	

Vince Caizzo BTWA		Eddie Lentz WSW1	
Eddie Lentz WSW1	3007	Fall 2:39	

Round 2

Jaron Depinet SEN3		Eddie Lentz WSW1	
Eddie Lentz WSW1	3023	Fall 2:59	

Vince Caizzo BTWA		Meredith Greenslade HSWA	
Meredith Greenslade HSWA	3024	Dec 2-0	

Round 3

Jaron Depinet SEN3		Vince Caizzo BTWA	
Vince Caizzo BTWA	3040	Fall 2:24	

Eddie Lentz WSW1		Eddie Lentz WSW1	
Meredith Greenslade HSWA	3041	Dec 4-2	

WRESTLERS

- J. Depinet (SEN3)
- M. Greenslade (HSWA)
- V. Caizzo (BTWA)
- E. Lentz (WSW1)

E. Lentz (WSW1)	1ST
M. Greenslade (HSWA)	2ND
V. Caizzo (BTWA)	3RD
J. Depinet (SEN3)	4TH

Oak Harbor Rocket Open

Division 4 Open 95 Open

Round 1

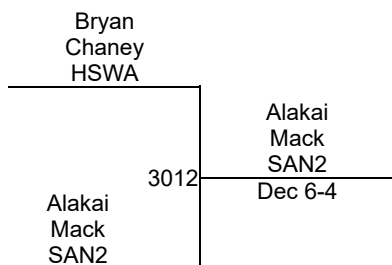

Round 2

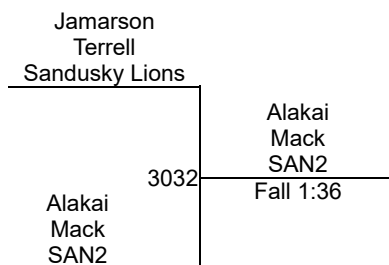

Round 3

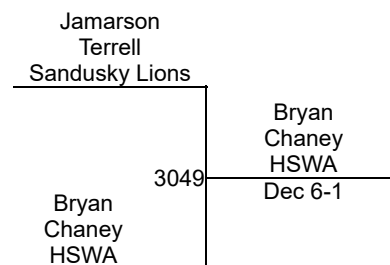

A. Mack (SAN2)

1ST

B. Chaney (HSWA)

2ND

J. Terrell (Sandusky Lions)

3RD

Oak Harbor Rocket Open

Division 4 Open 110 Open

Round 1

Logan Briggs OAK3		Ryan Moore PBG1	
	3008	Fall 0:44	

Amaree Mack SAN2		Spencer Schultz OAK3	
	3009	Dec 7-5	

Round 2

Logan Briggs OAK3		Logan Briggs OAK3	
	3025	SV-1 9-4	

Amaree Mack SAN2		Ryan Moore PBG1	
	3026	Fall 0:52	

Round 3

Logan Briggs OAK3		Amaree Mack SAN2	
	3042	Fall 2:34	

Spencer Schultz OAK3		Ryan Moore PBG1	
	3043	Dec 6-0	

WRESTLERS

L. Briggs (OAK3)

R. Moore (PBG1)

A. Mack (SAN2)

S. Schultz (OAK3)

R. Moore (PBG1)

1ST

A. Mack (SAN2)

2ND

L. Briggs (OAK3)

3RD

S. Schultz (OAK3)

4TH

Oak Harbor Rocket Open

Division 4 Open 129 Open

Round 1

Round 2

Round 3

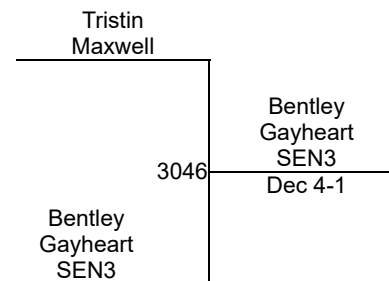
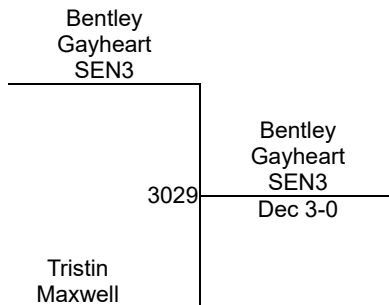
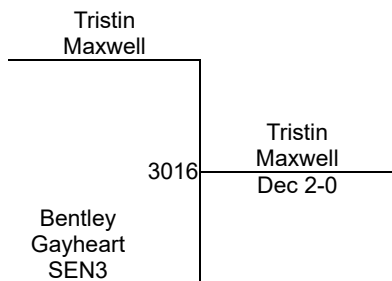

B. Gayheart (SEN3)
1ST

T. Maxwell ()
2ND

Oak Harbor Rocket Open

Division 4 Open 158 Open

Round 1

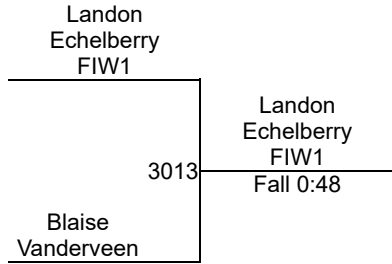

Round 2

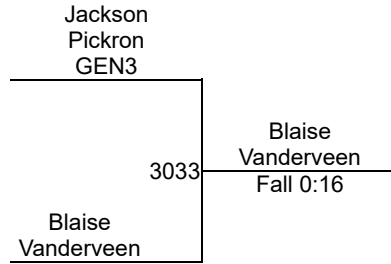

Round 3

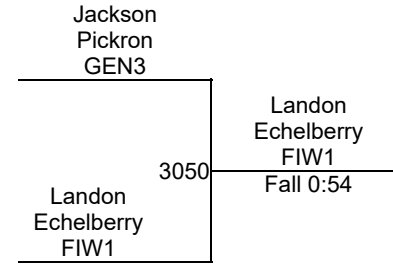

L. Echelberry (FIW1)
1ST

B. Vanderveen ()
2ND

J. Pickron (GEN3)
3RD